

Traffic Impact Study

Oldham Village

Lee's Summit, Missouri

Prepared For:

Engineering Solutions

Date:

August 2024

Kimley»Horn



Traffic Impact Study

Oldham Village

Lee's Summit, Missouri

Prepared for:
Engineering Solutions
50 SE 30th Street,
Lee's Summit, Missouri 64082

Prepared by:
Kimley-Horn and Associates, Inc.
805 Pennsylvania Avenue, Suite 150
Kansas City, Missouri 64105



8/12/2024

This document, together with the concepts and designs presented herein, as an instrument of service, is intended only for the specific purpose and client for which it was prepared. Reuse of and improper reliance on this document without written authorization and adaptation by Kimley-Horn and Associates, Inc. shall be without liability to Kimley-Horn and Associates, Inc.

CONTENTS

1.0 INTRODUCTION.....	1
1.1 REPORT PURPOSE AND OBJECTIVES.....	1
2.0 EXISTING CONDITIONS.....	2
2.1 STUDY AREA.....	2
2.2 STREET NETWORK.....	2
2.3 DATA COLLECTION.....	3
3.0 PROPOSED DEVELOPMENT.....	4
3.1 SITE PLAN DESCRIPTION.....	4
3.2 SITE ACCESS.....	5
3.3 TRIP GENERATION.....	6
3.4 PROJECT TRIP DISTRIBUTION AND ASSIGNMENT.....	8
4.0 ACCESS MANAGEMENT.....	9
4.1 ACCESS SPACING.....	9
4.2 THROAT LENGTH.....	10
4.3 TURN LANE ANALYSIS.....	11
5.0 INTERSECTION CAPACITY ANALYSIS.....	12
5.1 LEVEL OF SERVICE OVERVIEW.....	12
5.2 EXISTING CONDITIONS ANALYSIS.....	13
5.3 EXISTING + PHASE 1 DEVELOPMENT CONDITIONS ANALYSIS.....	14
5.4 EXISTING + FULL DEVELOPMENT CONDITIONS ANALYSIS.....	17
5.5 FUTURE (YEAR 2044) CONDITIONS ANALYSIS.....	20
6.0 CONCLUSIONS AND RECOMMENDATIONS.....	22
APPENDIX.....	25

TABLES

TABLE 1: PROPOSED DEVELOPMENT TRIP GENERATION.....	6
TABLE 2: COMPARISON OF DEVELOPMENT TRIPS	7
TABLE 3: PROPOSED DEVELOPMENT TRIP DISTRIBUTION	8
TABLE 4: DRIVEWAY THROAT LENGTH.....	10
TABLE 5: LEVEL OF SERVICE	12
TABLE 6: EXISTING PEAK HOUR CONDITIONS	13
TABLE 7: EXISTING + PHASE 1 DEVELOPMENT PEAK HOUR CONDITIONS.....	14
TABLE 8: EXISTING + FULL DEVELOPMENT PEAK HOUR CONDITIONS.....	19
TABLE 9: FUTURE (YEAR 2044) PEAK HOUR CONDITIONS	21

EXHIBITS (SEE APPENDIX A)

- EXHIBIT 1: PROJECT SITE LOCATION AND STUDY AREA
- EXHIBIT 2: EXISTING CONDITIONS PEAK HOUR TRAFFIC VOLUMES
- EXHIBIT 3: EXISTING CONDITIONS GEOMETRY AND INTERSECTION CONTROL
- EXHIBIT 4: EXISTING CONDITIONS 95TH PERCENTILE QUEUE LENGTHS
- EXHIBIT 5: PHASE 1 STREET NETWORK
- EXHIBIT 6: PHASE 1 PRIMARY TRIP DISTRIBUTION
- EXHIBIT 7: PHASE 1 PASS-BY DISTRIBUTION
- EXHIBIT 8: PHASE 1 TOTAL SITE TRIPS
- EXHIBIT 9: EXISTING PLUS PHASE 1 DEVELOPMENT PEAK HOUR TRAFFIC VOLUMES
- EXHIBIT 10: EXISTING PLUS PHASE 1 GEOMETRY AND INTERSECTION CONTROL
- EXHIBIT 11: EXISTING PLUS PHASE 1 DEVELOPMENT 95TH PERCENTILE QUEUE LENGTHS
- EXHIBIT 12: PHASE 1 AND 2 STREET NETWORK
- EXHIBIT 13: PHASE 2 PRIMARY TRIP DISTRIBUTION
- EXHIBIT 14: PHASE 2 PASS-BY TRIP DISTRIBUTION
- EXHIBIT 15: PHASE 2 TOTAL SITE TRIPS
- EXHIBIT 16: EXISTING PLUS FULL DEVELOPMENT PEAK HOUR TRAFFIC VOLUMES
- EXHIBIT 17: EXISTING PLUS FULL DEVELOPMENT GEOMETRY AND INTERSECTION CONTROL
- EXHIBIT 18: EXISTING PLUS FULL DEVELOPMENT 95TH PERCENTILE QUEUE LENGTHS
- EXHIBIT 19: FUTURE CONDITIONS PEAK HOUR TRAFFIC VOLUMES
- EXHIBIT 20: FUTURE CONDITIONS GEOMETRY AND INTERSECTION CONTROL
- EXHIBIT 21: FUTURE CONDITIONS 95TH PERCENTILE QUEUE LENGTHS

1.0 INTRODUCTION

This report serves as the traffic impact study for the Oldham Village development, generally located in the southwest quadrant of the US-50 Highway (US-50) and M-291 Highway (M-291) interchange in Lee's Summit, Missouri. The location of the development is shown on **Exhibit 1** in **Appendix A**.

1.1 REPORT PURPOSE AND OBJECTIVES

The purpose of this study is to address traffic and transportation impacts of the proposed development on surrounding streets and intersections. This traffic impact study was prepared based on criteria set forth by the City of Lee's Summit *Access Management Code* and the Missouri Department of Transportation (MoDOT) *Engineering Policy Guide*. The following information is provided:

- A description and map of the existing and proposed street network to be affected by the proposed development. This information includes existing roadway characteristics and existing traffic volumes.
- Trip generation calculations based on the Institute of Traffic Engineers (ITE) *Trip Generation Manual*, 11th Edition, for the proposed development. In addition, projected trip distributions onto the street network are provided.
- Development of future year (2044) traffic volume projections.
- Analysis of impacts of the traffic generated by the proposed development on the street network, including analysis of peak period levels of service (LOS), delay times, and queuing at study area intersections for the analysis scenarios.
- Review of site access points relative to the City's access management guidelines based on the *Access Management Code*.
- Discussion of potential improvements and traffic management measures identified to mitigate operational concerns.
- Signal warrant analysis for Oldham Parkway & Drive 2, based on the vehicular volume traffic signal warrants of the *Manual on Uniform Traffic Control Devices* (MUTCD).

In summary, the study is to determine the trip generation of the Oldham Village development, assign new development trips to the street network, analyze various scenarios to determine the impacts of proposed site traffic, and identify potential mitigation measures, if necessary, to achieve acceptable operations at the study intersections.

2.0 EXISTING CONDITIONS

2.1 STUDY AREA

The development site is generally located in the southwest quadrant of the M-291 & US-50 Interchange in Lee's Summit, Missouri. The entire site is approximately 45 acres. The northern portion of the site mostly consists of a paved parking lot currently used for long-term car storage. Two small, vacant commercial buildings are located in the northeast corner of the site, north of Oldham Parkway. South of the large parking lot is a large, vacant industrial building. The development site also includes several parcels between Jefferson Street and M-291, from Oldham Parkway to Persels Road. Land uses on these parcels currently include parking lots, contractor offices, auto repair businesses, and some commercial businesses located between Jefferson Street and M-291. Three of the small existing parcels in this area are not included in the proposed development.

The site is bounded on the north by Oldham Parkway, which is the frontage road along the south side of US-50. To the west of the site there is an office building owned by Summit Park Church along Oldham Parkway. South of the office building is a neighborhood of single-family homes and Pleasant Lea Park. To the south of the site undeveloped land and parking lots for Abundant Life Church. South of the site across Persels Road there is a business park and a gas station. The east edge of the site is bounded by Market Street and M-291. To the east of the site across M-291 is undeveloped land and one large industrial building.

Through discussion with City and MoDOT staff, the following intersections were included within the study area for the traffic analysis. The list provides the existing intersection control for each of the study intersections.

- Oldham Parkway & Ward Road (Traffic Signal)
- Oldham Parkway & Jefferson Street (Side Street Stop)
- M-291 & Oldham Parkway (Traffic Signal)
- Persels Road & Jefferson Street (Traffic Signal)
- M-291 & Persels Road/Bailey Road (Traffic Signal)

In 2015, MoDOT analyzed the US-50 & M-291 interchange prior to a major construction project that included reconfiguring the interchange. The project and analysis also included the M-291 corridor from US-50 to Persels Road, including the intersection at Oldham Parkway. As part of the analysis major commercial developments were assumed to be constructed to the west and the east of M-291 along Oldham Parkway. The assumptions made for the land uses west of the interchange were similar to the proposed development, therefore the interchange was not identified for analysis in this study.

2.2 STREET NETWORK

The existing street network within the study area includes US-50, M-291, Oldham Parkway, Jefferson Street, Persels Road, Bailey Road, and Ward Road. The following provides a summary of the existing street network within the study area:

US-50 is an east-west freeway that is part of the regional highway system. US-50 is a four-lane divided freeway with a posted speed limit of 60 miles per hour (mph). There is an interchange along US-50 at M-291. The interchange was reconstructed in 2018 as a diverging diamond interchange. The crossover on the north side of US-50 is a roundabout intersection and the crossover on the south side is signalized.

M-291 is a north-south expressway that connects the Kansas City metro area to Harrisonville to the south. M-291 is a six-lane divided roadway north of Persels/Bailey Road and a four-lane divided highway south of Persels/Bailey Road. M-291 has 12-foot travel lanes and 10-foot paved shoulders. The posted speed limit is 45 mph. Access is controlled along the portion of M-291 adjacent to the development site. There is a shared use path along the west side of M-291 extending south from the interchange to Oldham Parkway.

Oldham Parkway is a northwest-southeast commercial collector type street, according to the Lee's Summit Thoroughfare Master Plan. It serves as the frontage road along the south side of US-50, and it is maintained by MoDOT. Oldham Parkway is a two-lane undivided roadway with paved shoulders. No sidewalks are provided along Oldham Parkway. The posted speed limit is 35 mph. In the northeast corner of the development site, Oldham Parkway curves to become a north/south street that aligns with Jefferson Street at a T-intersection. Oldham Parkway follows an east/west alignment for a short distance between Jefferson Street and M-291. This east/west segment of Oldham Parkway was constructed with the interchange reconfiguration. This segment has two lanes in the westbound direction, a raised median, and four lanes in the eastbound direction. There are curbs and gutters with a shared use path along the south side of this street segment.

Jefferson Street is a north-south commercial collector type street extending south of Oldham Parkway. The three-lane roadway is 40 feet wide, measured between the backs of curbs, with a center two-way-left-turn lane and one travel lane in each direction. The posted speed limit is 35 mph. There is sidewalk along the west side of Jefferson Street and a shared use path on the east side.

Persels Road/Bailey Road is an east-west minor arterial street located at the far south end of the proposed development site. West of M-291 the road is called Persels Road and east of M-291, the road is named Bailey Road. Persels Road generally has a two-lane cross section that widens to a four-lane cross section for the segment between Jefferson Street and M-291. The four-lane segment includes one through lane in each direction, and the two center lanes are configured as left-turn lanes. Bailey Road is also generally a two-lane roadway that widens for turn lanes at the intersection with M-291. The posted speed limit is 35 mph for Persels Road and for Bailey Road. A sidewalk of varying widths is provided on the south side of Persels Road/Bailey Road throughout the study area. There is sidewalk on the north side of the Persels Road to the west of the site, but no other sidewalks along the north side of either roadway.

Ward Road is a north-south major arterial street located approximately one mile west of the proposed development site. The four-lane, undivided roadway has curb and gutters with sidewalk on the east side of the street and a shared use path along the west side. Ward Road connects to 3rd Street near a diamond interchange with US-50. The posted speed limit is 35 mph.

2.3 DATA COLLECTION

Turning Movement Counts (TMCs) were collected at the study intersections on Thursday, October 20th, 2022, and Saturday, October 22nd, 2022. The turning movement count data collected is included in **Appendix B**. The AM peak hour occurred between 7:15 AM and 8:15 AM, the PM peak hour occurred between 4:15 PM and 5:15 PM, and the Saturday peak hour occurred between 12:00 PM and 1:00 PM. The existing conditions peak hour turning movement volumes are shown on **Exhibit 2**. The existing geometry with lane configurations and intersection control at the study intersections is shown on **Exhibit 3**.

3.0 PROPOSED DEVELOPMENT

3.1 SITE PLAN DESCRIPTION

The proposed Oldham Village development is anticipated to be constructed in two phases. Phase 1 includes the realignment of Oldham Parkway through the northern portion of the site. At the northwest corner of the site, the roadway will be reconstructed as a two-lane roadway with curbs and gutters and sidewalk along the south side of the street. A large surface parking lot and a small retail building are to be located south of the street. A connection is shown between the parking lot and the adjacent existing office building in the northwest corner of the site. It is intended that the Summit Park Church will also use the large surface parking lot. The proposed site plan is included in **Appendix C** for reference.

Oldham Parkway will then curve to the south and widen for a raised median and left-turn lanes at intersections. Curbs and gutters and sidewalks will be provided along both sides of this street segment. The realignment of Oldham Parkway creates a larger area on the east side of the street for pad sites. The pad sites to the east of Oldham Parkway include a sit-down restaurant, two fast-food restaurants with drive through windows, a drive-through car wash, and two small buildings with retail space and drive-through coffee shops. West of Oldham Parkway, a sit-down restaurant with outdoor entertainment areas and a 120,000 square foot building for fitness and athletic events are to be located adjacent to the large surface parking lot.

Oldham Parkway will then curve to the east to align with the existing east/west segment of Oldham Parkway that intersects M-291. The roadway will widen for additional through lanes and turn lanes. Curbs and gutters and sidewalks will be provided along both sides of the street. The posted speed limit on Oldham Parkway will remain at 35 mph. The reconstructed and realigned section of Oldham Parkway will then be maintained by the City of Lee's Summit.

A portion of Jefferson Street will also be realigned to the west to create greater separation from M-291. Jefferson Street will intersect Oldham Parkway 260 feet west of the existing intersection. Access will be restricted to left-in/right-in/right-out (LIRIRO) only at this intersection. The raised median on Oldham Parkway will allow east/west left-turn movements, but north/south left-turn and through movements will be restricted. This restriction is due to the close proximity to the Oldham Parkway & M-291 intersection.

Phase 2 includes a four-story apartment building with 307 units located west of Jefferson Street and south of the fitness and athletic building. The parking lot for the apartments will also connect to the parking area for the fitness and athletic building near Access 1 providing circulation around the apartment building.

A number of pad sites are planned in the Phase 2 portion of the site between Jefferson Street and M-291, to the south of Oldham Parkway. The pad sites include two small buildings with retail space and coffee shops with drive through windows, a small grocery store and two fast-food restaurants with drive-through windows.

Market Street is an existing dead-end local street that will be almost fully removed to create more space for these pad sites. A small portion of Market Street will remain to provide access to two small existing properties that are not part of the proposed development. The existing properties will be accessed from a new east/west public street that connects Jefferson Street to the small remaining segment of Market Street that will remain. South of the new public street is a gas station with 10 fueling positions and a 4,500 square foot convenience store. A small existing office building in the northeast corner of Persels Road & Jefferson Street will remain, adjacent to the gas station.

3.2 SITE ACCESS

The Phase 1 portion of the site will be accessed from six driveway intersections with public streets. The Phase 1 accesses are described below. All access spacing distances provided are measured between centerlines of streets or driveways.

- The north leg of the realigned Oldham Parkway & Jefferson Street intersection will be the primary entrance to the pad sites located north and east of Oldham Parkway. This is a LIRIRO access and is approximately 600 feet west of M-291.
- Access 1 is a RIRO access on the west side of Oldham Parkway approximately 320 feet west of Jefferson Street, near the south end of the fitness and athletic building.
- Access 2 is a full-access intersection along Oldham Parkway approximately 345 feet north of Access 1. Access 2 serves the fitness and athletic building and the pad sites north and east of Oldham Parkway. Given the LIRIRO restriction at Jefferson Street, Access 2 will be the primary exit from the pad sites north and east of Oldham Parkway.
- Access 3 is a full-access driveway along Oldham Parkway located 375 feet north of Access 2. This driveway serves the restaurants on the east and west sides of Oldham Parkway.
- Access 4 is a full-access driveway along Oldham Parkway approximately 375 feet north and west of Access 3. It provides access to the small retail building and surface parking lot south of Oldham Parkway.
- Access 5 is a full-access driveway along Oldham Parkway located 380 feet west of Access 4 and 200 feet east of an existing access point to an office building.

The Phase 2 portion will be accessed primarily from four intersections along Jefferson Street, one access along Oldham Parkway, and one access along Persels Road. The Phase 2 accesses are described below. All access spacing distances provided are measured between centerlines of streets or driveways.

- A new full-access public street connection is proposed along the east side of Jefferson Street, approximately 375 feet north of Persels Road. This intersection would be 100 feet north of an existing private driveway on the east side of the street, and 120 feet south of a driveway for Abundant Life Church on the west side of the street. This public street would provide access to the gas station and to existing properties that are not part of the proposed development.
- Access 10 is a full-access driveway on the east side of Jefferson Street located 300 feet north of the proposed public street connection. This driveway provides access to two fast-food restaurants.
- Access 6 is a full-access driveway and is located approximately 275 feet north of Access 6. This driveway serves the apartments on the west side of Jefferson Street and serves two fast-food restaurants and one coffee shop.
- Access 7 is a full-access driveway on the east side of Jefferson Street located approximately 160 feet north of Access 6 and 430 feet south of Oldham Parkway. This driveway serves a coffee shop and small retail building as well as the small grocery store. This access continues north to Oldham Parkway as Access 8.
- Access 8 is a right-in/right-out driveway on the south side of Oldham Parkway located approximately 275 feet east of Jefferson Street intersection and 325 feet west of M-291.
- Access 9 is a right-in only driveway serving the gas station with convenience store and is located approximately 175 feet east of the intersection at Jefferson Street & Persels Road and 400 feet west of M-291.

3.3 TRIP GENERATION

Trip generation estimates were prepared using the ITE *Trip Generation Manual*, 11th Edition. **Table 1** shows the expected trips to be generated by each phase of the proposed development.

TABLE 1: PROPOSED DEVELOPMENT TRIP GENERATION

Land Use Description	ITE LUC	Intensity / Units	Daily	AM Peak Hour			PM Peak Hour			Saturday Peak Hour		
				In	Out	Total	In	Out	Total	In	Out	Total
Phase 1												
Recreational Community Center	495	120,000 SF	3,458	151	78	229	141	159	300	69	59	128
Strip Retail Plaza (<40k)	822	7,500 SF	546	11	7	18	25	24	49	25	24	49
High Turnover Sit-Down Restaurant	932	17,696 SF	1,896	93	76	169	98	62	160	101	97	198
Fast Food Restaurant with Drive-Through	934	7,955 SF	3,716	181	174	355	137	126	263	224	215	439
Coffee Shop with Drive-Through	937	4,075 SF	2,172	178	172	350	79	80	159	179	179	358
Automated Car Wash	948	1 Tunnel	780	20	20	40	39	39	78	19	22	41
Phase 1 Trips (unreduced)			12,568	634	527	1,161	519	490	1,009	617	596	1,213
Phase 1 Pass-By Trips			3,107	106	106	212	128	128	256	82	82	164
Phase 1 Primary Trips			9,462	528	421	949	391	362	753	535	514	1,049
Phase 2												
Multifamily Housing (Mid-Rise)	221	307 Dwelling Units	1,418	28	95	123	73	47	120	63	61	124
Strip Retail Plaza (<40k)	822	2,700 SF	344	4	2	6	9	9	18	9	9	18
Supermarket	850	9,300 SF	1,315	16	11	27	42	41	83	47	47	94
Fast Food Restaurant with Drive-Through	934	7,800 SF	3,646	177	171	348	134	124	258	220	211	431
Coffee Shop with Drive-Through	937	3,075 SF	1,641	135	129	264	60	60	120	135	135	270
Convenience Store/Gas Station	945	10 Fueling Positions	2,571	135	135	270	114	114	228	104	100	204
Phase 2 Trips (unreduced)			10,935	495	543	1,038	432	395	827	578	563	1,141
Phase 2 Pass-By Trips			3,107	106	106	212	128	128	256	82	82	164
Phase 2 Primary Trips			7,829	389	437	826	304	267	571	496	481	977
Full Development												
Total Pass-By Trips			6,214	212	212	424	256	256	512	164	164	328
Total Primary Trips			17,291	917	858	1,775	695	629	1,324	1,031	995	2,026

Appendix D includes the calculations used to determine the trip generation of the proposed development.

Pass-by trip calculation was included in the trip generation estimates in **Table 1** because of the gas station, restaurant, and retail land uses. Pass-by trips occur when a driver already traveling on the street adjacent to the development makes a trip to the development while in route to another destination. Therefore, pass-by trips do not add new trips to the street network, but they do increase turning movements in and out of the development site accesses.

According to the *Trip Generation Handbook*, gas stations and restaurants can have pass-by rates that account for more than 50 percent of trips generated by the land use. This would equate to a significant portion of the existing traffic volume on M-291 being pass-by traffic. Therefore, the total pass-by trips in **Table 1** were estimated to be 15% of the existing volume along M-291 during each peak hour. The total number of total pass-by trips were divided equally between Phase 1 and Phase 2.

Table 2 provides a comparison of the peak hour trips assumed for the site in the analysis MoDOT prepared for the US-50 & M-291 interchange in 2015 and the trip generation for the proposed development. In the MoDOT analysis, the Saturday peak hour was not evaluated.

TABLE 2: COMPARISON OF DEVELOPMENT TRIPS

Study	Trip Type	AM Peak Hour			PM Peak Hour		
		In	Out	Total	In	Out	Total
Proposed Development Trips	Primary	917	858	1,775	695	629	1,324
	Pass-By	212	212	424	256	256	212
	Total	1,129	1,070	2,199	951	885	1,836
US-50/M-291 Interchange Analysis	Primary	190	182	372	562	575	1,137
	Pass-By	80	51	131	270	280	550
	Total	270	233	503	832	855	1,687
Total Difference		859	837	1,696	119	30	149

The difference in trips in **Table 2** indicates a much higher AM peak hour trip generation than was assumed for the interchange analysis. In the interchange study, a high level of retail land uses was assumed for this site. With all of the restaurant land uses proposed in the development plan, the trip generation in **Table 1** indicates a high level of trip generation during the AM peak hour.

The PM peak hour has a much higher volume existing traffic already traveling through the study intersections than the AM peak hour. Therefore, the PM peak hour is the critical time period for analysis of the study area. During the PM peak hour, the proposed trip generation is slightly higher than what was assumed in the interchange analysis. Therefore, the analysis performed by MoDOT in 2015 is still valid for the interchange and the interchange was not evaluated in this study.

3.4 PROJECT TRIP DISTRIBUTION AND ASSIGNMENT

The estimated trips generated by the proposed development were assigned to the street network based on the trip distribution summarized in **Table 3**. This distribution is based on existing traffic patterns, the surrounding street network, population density, and engineering judgment. These distributions generally follow what was used for MoDOT's analysis for the US-50 & 291 interchange.

TABLE 3: PROPOSED DEVELOPMENT TRIP DISTRIBUTION

Direction To/From	Percentage
North on M-291	50%
South on M-291	20%
East on Bailey Road	5%
West on Persels Road	10%
South on Ward Road	5%
South on Jefferson Street	5%
North on Ward Road	5%
Total	100%

Peak hour site trips are predominately expected to be traveling to/from the north and south on M-291 as it is an expressway that connects to the regional highway system. Likewise, pass-by trips are expected to be from drivers traveling along M-291.

Detailed distribution patterns through the study intersections were developed for each phase of the proposed development. The Phase 1 street network and study intersections are shown on **Exhibit 5**. The Phase 1 primary trip distribution is shown on **Exhibit 6** and the Phase 1 pass-by trip distribution is shown on **Exhibit 7**. The proposed Phase 1 site trip assignments are illustrated on **Exhibit 8**. The proposed Phase 1 site trip assignments were added to the Existing Conditions traffic volumes. **Exhibit 9** illustrates the Existing plus Phase 1 Development peak hour traffic volumes.

For **Exhibit 9**, the Existing Conditions traffic volumes were adjusted for the realignment and change to LIRIRO access at Oldham Parkway & Jefferson Street. Westbound right-turn and southbound left-turn movements were changed to be east/west through movements. Southbound through movements were adjusted to be eastbound right-turn movements. Northbound through movements were adjusted to become northbound right-turn movements. These adjusted movements were then assigned to be eastbound U-turn movements at Oldham Parkway & M-291.

The Phase 1 and 2 street network and study intersections are shown on **Exhibit 12**. The Phase 2 primary trip distribution is shown on **Exhibit 13** and the Phase 2 pass-by trip distribution is shown on **Exhibit 14**. The proposed Phase 2 site trip assignments are illustrated on **Exhibit 15**. The proposed Phase 2 site trip assignments were added to the Existing plus Phase 1 Development traffic volumes. **Exhibit 16** illustrates the Existing plus Phase Full Development peak hour traffic volumes.

4.0 ACCESS MANAGEMENT

The City of Lee's Summit's *Access Management Code* (AMC) provides criteria for minimum spacing between intersections and driveways, throat lengths, and the need for turn lanes at intersections. These items are discussed in the following paragraphs.

4.1 ACCESS SPACING

The AMC includes requirements for minimum spacing between street connections, depending on street classification and the type of access. Along commercial collector streets such as Oldham Parkway and Jefferson Street, the minimum spacing for full access intersections is 300 feet, measured between centerlines. Based on the intersection spacings described in Section 3.2 of this study, the relocated Oldham Parkway & Jefferson Street intersection meets the minimum spacing requirements. Accesses 1 through 4 along Oldham Parkway also meet the minimum spacing requirements. Access 5 in the northwest corner of the site is spaced 200 feet east of an existing driveway to an office building, which does not meet the minimum spacing requirement. It is worth noting that Access 5 is in the location of an existing driveway and is expected to have a low volume of traffic.

Access 8 is a RIRO access along the south side of Oldham Parkway. This access is located 325 feet west of M-291, which is within the functional area of the intersection.

Along Jefferson Street, none of the proposed accesses meet the minimum spacing requirements. Closely spaced driveways are proposed due to the small lot sizes of the proposed development and the lack of access from other sides of the sites. Efforts have been made to share access with adjoining properties wherever possible.

For driveways along minor arterial streets such as Persels Road the minimum spacing is 400 feet. Access 9 is a right-in only driveway that just meets the minimum spacing from M-291, however the spacing to Jefferson Street is not met. As a right-in only driveway with a separate right-turn lane, the spacing from Jefferson Street should not cause any safety or operational concerns. To ensure that the driveway operates as right-in only, a raised median on Persels Road would be appropriate.

4.2 THROAT LENGTH

A driveway's throat length is the distance along a driveway from the intersecting roadway to the first location on site where a driver can make a turn. Adequate throat lengths minimize the potential for inbound traffic to queue onto the public street. The throat length also provides space for outbound traffic to queue without adversely impacting site circulation.

The throat length requirements in the *Access Management Code* are based on the number of trips generated by a development and the amount of stacking that will occur at the access driveway. The provided and required throat lengths at each site access point are provided in **Table 4** and are based on the Existing Plus Full Development traffic volumes shown on **Exhibit 16**.

TABLE 4: DRIVEWAY THROAT LENGTH

Site Driveway	Approach	Peak Hour Trips			Provided Throat Length	Required Throat Length	
		AM	PM	Sat			
2	Jefferson Street	SB	326	280	310	290 feet	100 feet
6	Access 1	EB	21	18	26	75 feet	50 feet
7	Access 2	EB	294	169	319	250 feet	100 feet
		WB	382	364	408	300 feet	125 feet
8	Access 3	EB	88	79	89	100 feet	75 feet
		WB	91	75	98	50 feet	75 feet
9	Access 4	NB	19	16	20	65 feet	50 feet
10	Access 5	NB	18	16	20	100 feet	50 feet
11	Public Street	WB	238	182	256	105 feet	100 feet
12	Access 10	WB	93	70	106	280 feet	100 feet
13	Access 6	EB	125	85	147	90 feet	100 feet
		WB	229	190	244	60 feet	100 feet
14	Access 7	WB	142	137	169	235 feet	100 feet
15	Access 8	NB	65	47	68	90 feet	75 feet
16	Access 9	NB	146	134	161	110 feet	100 feet

The throat lengths provided in **Table 4** indicate that nearly all driveways meet the minimum throat length requirements. At the westbound approach of Access 3, the throat length is just below the required throat length. At Access 6, both the eastbound and westbound approaches have throat lengths that are less than the required throat length. Access 10 also has a throat length less than the required throat length. Queuing within the throat length of the driveways will be discussed in the Intersection Capacity Analysis section of this study.

The *Access Management Code* states that for driveways with 100 vehicles per hour, the minimum throat length may be longer if necessary to accommodate queue storage. Queue storage for the applicable driveways is discussed in the Existing plus Development Analysis section of this study.

4.3 TURN LANE ANALYSIS

Left-turn lanes are to be provided on collector streets at connections where the left-turn volume is at least 30 vehicles in any hour. The site plan indicates that left-turn lanes are provided on Oldham Parkway at all such locations, except for Access 3. At Access 3, the northbound left-turn volume exceeds 30 during each peak hour. With only 300 feet of separation between Access 2 and 3, there is not enough distance along Oldham Parkway to provide left-turn lanes of at least 150 feet for both of these intersections. Access 3 should be shifted north and a northbound left-turn lane with a minimum storage length of 150 feet should be provided. All proposed left-turn lanes on Oldham Parkway should have a minimum storage length of 150 feet.

Jefferson Street is currently a three-lane street with a center two-way left-turn lane. The realigned portion of Jefferson Street should also be a three-lane street. This provides left-turn lanes at all accesses proposed along Jefferson Street.

The AMC states that right-turn lanes are required on collector streets where the right-turn volume is at least 100 vehicles in any hour. All right-turn lanes should have a minimum storage length of 150 feet plus an appropriate taper.

For the proposed development, right-turn lanes are shown on the site plan at all locations with 100 right-turns in a peak hour, except for the westbound right-turn movement at Oldham Parkway & Jefferson Street. At this intersection there are two westbound lanes proposed. The right lane terminates as a right-turn lane at Access 2. There is minimal right-turn volume at Access 2. Therefore, the right lane on Oldham Parkway will essentially function as the right-turn lane at Jefferson Street, since nearly all the volume in this lane will be turning right at Jefferson Street.

Exhibit 10 shows the Existing plus Phase 1 geometry and intersection controls, which includes the turn lanes shown on the site plan and the turn lanes identified based on access management requirements. Similarly, **Exhibit 17** shows the Existing plus Full Development geometry and intersection controls.

5.0 INTERSECTION CAPACITY ANALYSIS

5.1 LEVEL OF SERVICE OVERVIEW

Intersection capacity analysis was performed at the study intersections for the following three scenarios:

- Existing Conditions
- Existing + Phase 1 Development Conditions
- Existing + Full Development Conditions
- Future Conditions

The capacity analysis was performed for the weekday AM and PM peak hours using Synchro traffic modeling software to determine intersection delay and level of service (LOS). Calculations were performed based on the methodologies outlined in the *Highway Capacity Manual (HCM)*, 7th Edition, which is published by the Transportation Research Board.

LOS is a qualitative measure used by traffic engineers to describe the operations of an intersection. It ranges from A to F, with A being the best and F being the worst level of operation. LOS A conditions are characterized by minimal vehicle delay and free-flow conditions, while LOS F is characterized by long vehicle delay – usually when demand exceeds available roadway capacity. **Table 5** shows the definition of LOS for unsignalized and signalized intersections.

TABLE 5: LEVEL OF SERVICE

Level of Service	Average Control Delay (seconds/vehicle) at:	
	Unsignalized Intersections	Signalized Intersections
A	0 – 10	0 – 10
B	> 10 – 15	> 10 – 20
C	> 15 – 25	> 20 – 35
D	> 25 – 35	> 35 – 55
E	> 35 – 50	> 55 – 80
F	> 50	> 80

Levels of service are evaluated based on the movement groupings which are required to yield to other traffic. Typically, these are left turns off the major street and the side street approaches for two-way stop-controlled intersections. For signalized intersections each movement grouping is evaluated, and LOS is evaluated for the intersection as a whole.

The City of Lee's Summit has adopted LOS C as the minimum desirable LOS. However, LOS D and E may be considered acceptable for low to moderate traffic volumes, the availability of alternate routes, and the duration of activity resulting in lower LOS.

Traffic queues were also evaluated as part of the analyses. Long traffic queues which extend beyond the amount of storage available, either between intersections or within turn lanes, can have significant impacts on operations. The 95th percentile vehicular queues were analyzed to ensure the analyses are reflective of the physical constraints of the study intersections and to identify if additional storage is needed for turn

lanes. The 95th percentile queue represents the queue length that has only a 5% chance of being exceeded during the analysis period.

5.2 EXISTING CONDITIONS ANALYSIS

Capacity analysis was conducted for existing traffic conditions at the study intersections to determine baseline conditions for the existing analysis year and to calibrate the models. The analysis was performed for weekday AM, PM, and Saturday peak hours and is based on the traffic volumes, lane configurations, and traffic controls shown in **Exhibits 2** and **3**. The 95th percentile queues for each movement are shown in **Exhibit 4**. The Synchro reports are provided in **Appendix E**.

Table 6 provides a summary of the capacity analysis at the study intersections.

TABLE 6: EXISTING PEAK HOUR CONDITIONS

Intersection		Movement	Operational Analysis Results					
			AM Peak Hour		PM Peak Hour		Sat Peak Hour	
			Delay (sec/veh)	LOS	Delay (sec/veh)	LOS	Delay (sec/veh)	LOS
1	Oldham Pkwy. & Ward Road	Signalized	19.1	B	17.7	B	17.9	B
2	Oldham Pkwy. & Jefferson Street	NB	11.6	B	9.6	A	9.2	A
		SB	15.0	B	11.1	B	9.4	A
3	M-291 & Oldham Parkway	Signalized	5.3	A	8.3	A	4.4	A
4	Persels Road & Jefferson Street	Signalized	27.2	C	28.5	C	17.0	B
5	M-291 & Persels Rd./ Bailey Rd.	Signalized	34.1	C	47.1	D	21.7	C

The results in **Table 6** indicate that most of the study intersections are projected to operate at acceptable levels of service. During the PM peak hour, the intersection at M-291 & Persels Road/Bailey Road is projected to operate at LOS D. This is primarily due to the long cycle length on M-291. It is not uncommon for intersections along high volume roadways such as M-291 with 8-phase signals to operate at LOS D. During the PM peak hour, the eastbound left-turn movement at the intersection has a 95th percentile queue length of 202 feet, which exceeds the available storage length of one of the two turn lanes for this movement. The westbound left-turn lane at the closely spaced Market Street intersection limits the available storage length for the westbound left-turn movement at the M-291 intersection. The southbound through movement has a 95th percentile queue length of 843 feet, which is a lengthy queue, but it does clear within one cycle of the signal.

Several other queue lengths are worth noting. At the Persels Road & Jefferson Street intersection, the westbound left-turn queue nearly fills the available storage during the AM peak hour. This is most likely due to school traffic arriving at Summit Christian Academy, which is located south of the intersection on Jefferson Street.

At Oldham Parkway and Ward Road, southbound left-turn queues slightly exceed the short storage length of the left-turn lane. There is no ability to lengthen this lane because that would reduce the length of the adjacent northbound left-turn lane at the Ward Road & 3rd Street intersection.

5.3 EXISTING + PHASE 1 DEVELOPMENT CONDITIONS ANALYSIS

Capacity analysis was conducted for Existing plus Phase 1 Development Conditions at the study intersections to determine the impact of site generated traffic from Phase 1 of the proposed development. The cycle lengths were optimized at the study intersections for the analysis. The analysis was performed for weekday AM, PM and Saturday peak hours and is based on the traffic volumes, lane configurations, and traffic controls shown in **Exhibits 9** and **10**. The 95th percentile queues for each movement are shown in **Exhibit 11**. The Synchro reports are provided in **Appendix E**.

Table 7 provides a summary of the capacity analysis at the study intersections.

TABLE 7: EXISTING + PHASE 1 DEVELOPMENT PEAK HOUR CONDITIONS

Intersection		Movement	Operational Analysis Results					
			AM Peak Hour		PM Peak Hour		SAT Peak Hour	
			Delay (sec/veh)	LOS	Delay (sec/veh)	LOS	Delay (sec/veh)	LOS
1	Oldham Pkwy. & Ward Road	Signalized	15.9	B	14.5	B	14.7	B
2	Oldham Pkwy. & Jefferson Street	NB	11.0	B	10.6	B	10.5	B
		SB	10.9	B	10.2	B	10.5	B
		EBL	9.3	A	8.7	A	8.9	A
		WBL	9.6	A	8.9	A	8.9	A
3	M-291 & Oldham Parkway	Signalized	16.8	B	24.2	C	17.6	B
4	Persels Road & Jefferson Street	Signalized	28.1	C	48.0	D	14.6	B
5	M-291 & Persels Rd./ Bailey Rd.	Signalized	25.4	C	44.3	D	20.3	C
6	Oldham Parkway & Access 1	EBR	12.4	B	12.1	B	12.8	B
7	Oldham Parkway & Access 2	NBL	7.9	A	7.9	A	7.9	A
		SBL	7.8	A	7.7	A	7.6	A
		EBL	18.4	C	15.6	C	16.8	C
		EBT	11.8	B	11.4	B	11.4	B
		WBL	151.4	F	64.1	F	136.1	F
		WBT	16.1	C	14.4	B	14.6	B
8	Oldham Parkway & Access 3	NBL	7.6	A	7.6	A	7.5	A
		SBL	7.7	A	7.6	A	7.5	A
		EB	9.7	A	9.6	A	9.6	A
		WB	12.7	B	11.8	B	11.5	B
9	Oldham Parkway & Access 4	NB	9.7	A	9.6	A	9.4	A
		WBL	7.5	A	7.5	A	7.5	A
10	Oldham Parkway & Access 5	NB	9.8	A	9.6	A	9.4	A
		WBL	7.5	A	7.5	A	7.5	A

The results in **Table 7** indicate that most intersections operate acceptably with the addition site trips generated from Phase 1 of the proposed development. As in the Existing Conditions scenario, the M-291 & Persels Road/Bailey Road is projected to operate at LOS D during the PM peak hour. The 95th percentile queue length for the eastbound left-turn movement is projected to be 264 feet, which will extend back through the Persels Road & Market Street intersection. Long queues of southbound through traffic are projected during the PM peak hour, similar to existing conditions at the intersection.

The intersection at Persels Road & Jefferson Street is also projected to operate at LOS D. Westbound left-turn queues are projected to slightly increase with the addition of development traffic but are expected to be contained within the storage length of the turn lane.

The 95th percentile queue lengths for the movements exiting the site driveways are projected to be contained within the available throat lengths. While the provided throat length at Access 3 does not meet the minimum requirement, it is not expected to have an adverse impact on operations at the site driveway intersection.

All movements at the site driveways are projected to operate at LOS A or B during all peak hours except for one. The westbound left-turn movement at the Oldham Parkway & Access 2 intersection is projected to operate at LOS F across all peak hours. Due to the lower level of service for the movement, the intersection was also evaluated with all-way stop control. Lengthy queues and delays are projected for some movements with all-way stop control. As a signalized intersection an overall LOS A is projected for each peak hour. The evaluation of traffic signal control is discussed in the paragraphs below.

The decision to install a traffic signal is based on an engineering study as described in the MUTCD. Signal warrants included in the MUTCD are to be considered. The peak hour traffic volumes at the intersection were compared to the warranting thresholds of the Peak Hour Warrant. The volumes were found to be just below the warranting thresholds for this warrant. The signal warrant analysis is included in **Appendix F**.

The peak hour traffic volumes were also compared to the warranting thresholds of the Four-Hour Warrant. Each of the peak hour volumes far exceeds the minimum warranting thresholds of the Four-Hour Warrant. The signal warrant analysis is included in **Appendix F**. Traffic projections have not been developed for other hours of the day, so four hours of traffic volumes are not shown in the warrant analysis. Some assumptions can be made about other hours of an average day. The AM and PM peak hour traffic counts show that the volumes during both count periods, totaling 4 hours, were very similar to the peak hour volumes. Likewise, the time-of-day distributions from the *Trip Generation Manual* indicate that the hourly trips from the proposed land uses are consistent from 7:00 to 9:00 AM and from 4:00 to 6:00 PM. Therefore, it is likely that at least one other hour in the morning would have a similar volume to the AM peak hour. Also at least one other hour in the afternoon would have a similar volume to the PM peak hour. This indicates that the Four-Hour Warrant is expected to be satisfied.

The City of Lee's Summit encourages complete street design concepts to enhance access and safety for all road users. Pedestrian volumes are not considered in conjunction with the vehicular volume traffic signal warrants, but pedestrian access should be considered when evaluating the need for traffic signal installation. The development should include sidewalks and facilities to encourage walking and pedestrian access. It is likely that pedestrians would cross Oldham Parkway at Drive 2 when walking between the restaurants on the east side of the street and the field house and eventually the apartments that will be built during Phase 2 of the development on the west side of the street. A signal at Drive 2 would provide the safest form of control for pedestrians, due to the width of the intersection and volume of turning traffic.

The MUTCD states that the safe and efficient movement of all road users is the primary consideration in the engineering study to determine whether to install a traffic control signal. As a signalized intersection, vehicular delays will be minimal. The Four-Hour Warrant is expected to be satisfied with Phase 1 development traffic. Signalization will provide the safest form of control for pedestrians crossing Oldham Parkway. Given these factors, traffic signal installation is recommended for the Oldham Parkway & Drive 2 intersection.

A number of lanes and access control medians are shown on the site plan for Oldham Parkway west of M-291. The analysis indicates that these improvements operate well during the peak hours. The following list documents these improvements:

Oldham Parkway & M-291

- Construct an eastbound left-turn lane with a minimum storage length of 350 feet plus taper.
- Construct a second eastbound left turn lane. This lane will extend at least 300 feet west of Jefferson Street plus taper.
- Construct an eastbound right-turn lane with a minimum storage length of 350 feet plus taper.
- Construct two westbound lanes on Oldham Parkway, extending east of the intersection. The right lane should terminate as a right-turn lane at Access 2, and the left lane will continue as the through lane.

Oldham Parkway & Jefferson Street

- Construct a raised median on Oldham Parkway to restrict Jefferson Street access to left-in/right-in/right-out.
- Construct an eastbound left-turn lane with a minimum storage length of 150 feet plus taper.
- Construct a westbound left-turn lane with a minimum storage length of 200 feet plus taper.

Oldham Parkway & Access 2

- Install a traffic signal.
- Construct a northbound left-turn lane with a minimum storage length of 150 feet plus taper.
- Construct a southbound left-turn lane with a minimum storage length of 150 feet plus taper.
- Construct the eastbound and westbound approaches with three lanes, to provide one inbound lane and two outbound lanes.

Oldham Parkway & Access 3

- Construct a northbound left-turn lane with a minimum storage length of 150 feet plus taper. This will require moving the access farther to the north to allow for a 150-foot southbound left-turn lane to be constructed at Access 2.

Jefferson Street

- Construct the realigned portion of Jefferson Street as a three-lane roadway with a center two-way left-turn lane.

5.4 EXISTING + FULL DEVELOPMENT CONDITIONS ANALYSIS

Capacity analysis was conducted for Existing plus Full Development Conditions at the study intersections to determine the impact of site generated traffic from Phases 1 and 2 of the proposed development. The cycle lengths were optimized at the study intersections for the analysis. The analysis was performed for weekday AM, PM and Saturday peak hours and is based on the traffic volumes, lane configurations, and traffic controls shown on **Exhibits 16** and **17**. The 95th percentile queues for each movement are shown on **Exhibit 18**. The Synchro reports are provided in **Appendix E**.

Table 8 provides a summary of the capacity analysis at the study intersections.

The results in **Table 8** indicate that the intersections along the Oldham Parkway and the Jefferson Street corridors are projected to operate acceptably with the addition of site trips generated from both phases of the proposed development. The exception is the intersection of M-291 & Persels Road/Bailey Road. The intersection is projected to operate at an overall LOS E during the PM peak hour, with 55.1 seconds of delay. This level of delay slightly exceeds the 55 second threshold for LOS D conditions. Long queues of 900 feet projected for the southbound through lanes, however these queues are projected to clear during each cycle of the signal.

On the eastbound Persels Road approach to the intersection, long queues are projected to extend back to the Jefferson Street intersection with a single shared right-turn/through lane. The need for an eastbound right-turn lane was identified to mitigate this level of queuing. With the separate eastbound right-turn lane, the queue lengths in **Exhibit 18** indicate that all queues in the eastbound through lane are projected to be less than 200 feet.

During the PM peak hour, the eastbound left-turn movement at the intersection is projected to have a 95th percentile queue length of 273 feet, extending through the Market Street intersection. To reduce the number of potential conflict points in this area and provide more queue storage, a raised median is recommended along Persels Road. The median will restrict left-turn movements at the intersection with Market Street; resulting in RIRO access only at Persels Road. Since a left-turn lane will no longer be needed for the Market Street intersection, the eastbound left-turn lane for the M-291 & Persels Road intersection and the westbound left-turn lane for the Persels Road & Jefferson Street intersection can be lengthened.

At the intersection of M-291 & Oldham Parkway, the 95th percentile queue in the southbound right-turn lane is projected to exceed the storage length of the existing turn lane during the PM peak hour. The southbound right-turn lane should be lengthened to provide a storage length equal to the left-turn lanes on the southbound approach.

A summary of the Phase 2 improvements identified is provided below:

Oldham Parkway & M-291

- Lengthen the southbound right-turn lane to provide a minimum storage length of 300 feet plus taper.

Persels Road & M-291

- Construct an eastbound right-turn lane with a minimum storage length of 150 feet plus taper.

Persels Road & Market Street

- Construct a raised median on Persels Road to restrict Market Street access to right-in/right-out.

Persels Road & Gas Station Access

- Construct a westbound right-turn lane with a minimum storage length of 150 feet plus taper.

The Persels Road & Jefferson Street intersection is projected to operate at LOS D during all peak hours. The queues for the westbound left-turn movement are projected to exceed the storage available for this movement. Some additional storage can be provided for this movement when the median is added to Persels Road.

At the site driveways, the 95th percentile queue lengths are expected to be contained within the available throat length, even for the driveways with throats that are less the lengths required by the *Access Management Code*. Therefore the short throat lengths are not expected to have an adverse impact on operations at the site driveway intersections.

TABLE 8: EXISTING + FULL DEVELOPMENT PEAK HOUR CONDITIONS

Intersection		Movement	Operational Analysis Results					
			AM Peak Hour		PM Peak Hour		SAT Peak Hour	
			Delay (sec/veh)	LOS	Delay (sec/veh)	LOS	Delay (sec/veh)	LOS
1	Oldham Pkwy. & Ward Road	Signalized	15.7	B	14.6	B	14.8	B
2	Oldham Pkwy. & Jefferson Street	NB	13.7	B	12.3	B	13.3	B
		SB	10.8	B	10.2	B	10.3	B
		EBL	9.2	A	8.7	A	8.8	A
		WBL	11.2	B	9.9	A	10.5	B
3	M-291 & Oldham Parkway	Signalized	24.9	C	27.7	C	27.4	C
4	Persels Road & Jefferson Street	Signalized	46.7	D	48.7	D	49.7	D
5	M-291 & Persels Rd./ Bailey Rd.	Signalized	35.0	D	55.1	E	32.1	C
6	Oldham Parkway & Access 1	EBR	12.3	B	12.2	B	12.8	B
7	Oldham Parkway & Access 2	Signalized	8.3	A	7.7	A	8.6	A
8	Oldham Parkway & Access 3	NBL	7.6	A	7.6	A	7.6	A
		SBL	7.7	A	7.6	A	7.5	A
		EB	9.7	A	9.7	A	9.6	A
		WB	12.6	B	11.9	B	11.6	B
9	Oldham Parkway & Access 4	NB	9.7	A	9.7	A	9.5	A
		WBL	7.5	A	7.6	A	7.5	A
10	Oldham Parkway & Access 5	NB	9.8	A	9.7	A	9.5	A
		WBL	7.5	A	7.6	A	7.5	A
11	Jefferson Street & Public Street	SBL	7.7	A	7.6	A	7.6	A
		WB	14.4	B	11.7	B	12.4	B
12	Jefferson Street & Access 10	SBL	7.7	A	7.6	A	7.6	A
		WB	10.6	B	9.8	B	10.0	B
13	Jefferson Street & Access 6	NBL	8.0	A	7.6	A	7.6	A
		SBL	7.7	A	7.6	A	7.7	A
		EB	15.8	C	12.1	B	13.2	B
		WB	12.6	B	10.9	B	11.1	B
14	Jefferson Street & Access 7	SBL	8.0	A	7.8	A	7.9	A
		WB	12.0	B	10.6	B	11.2	B
15	Oldham Parkway & Access 8	NBR	9.9	A	9.7	A	9.9	A

5.5 FUTURE (YEAR 2044) CONDITIONS ANALYSIS

For the future year, background traffic growth was added to the existing traffic volumes, then the proposed development and planned development site trips were added. To estimate background traffic growth, the existing traffic volumes at the study intersections were assumed to increase at a rate of 1% per year to estimate conditions in 2044. In the future, development is assumed on the undeveloped land to the east of M-291. The same development trip assumptions from the MoDOT traffic analysis for the US-50 & M-291 interchange were used.

The Future (Year 2044) peak hour traffic volumes are shown on **Exhibit 12**.

In the future additional capacity improvements are needed to achieve acceptable levels of service. These improvements are listed below:

M-291 & Oldham Parkway

- Extend the southbound right-turn lane to the M-291 southbound exit ramp from US-50. This is consistent with the future conditions analysis from the US-50 & M-291 interchange project.

M-291 & Persels Road/Bailey Road

- Construct an additional eastbound through lane.
- Construct an additional westbound through lane. This lane will terminate as a right-turn lane at Jefferson Street.
- Construct an additional northbound left-turn lane.
- Construct an additional southbound left-turn lane.
- Construct an additional southbound through lane.

Capacity analysis was conducted for Future Conditions at the study intersections to determine the need for capacity improvements within the study network in the future. The cycle lengths were optimized at the study intersections for the analysis. The analysis was performed for weekday AM, PM and Saturday peak hours and is based on the traffic volumes, lane configurations, and intersection controls shown on **Exhibits 19** and **20**. The 95th percentile queues for each movement are shown on **Exhibit 21**. The Synchro reports are provided in **Appendix F**.

Table 9 provides a summary of the capacity analysis at the study intersections.

The analysis results indicate that the signalized intersections along M-291 are projected to operate at LOS E in the future during the PM and Saturday peak hour. Several individual movements at these intersections are projected to operate over capacity in the future. Additional improvements will be needed to achieve acceptable levels of service at these intersections if the future volumes projected in this study are realized.

At the site driveways, all 95th percentile queue lengths are expected to be contained within the available throat length.

TABLE 9: FUTURE (YEAR 2044) PEAK HOUR CONDITIONS

Intersection	Movement	Operational Analysis Results						
		AM Peak Hour		PM Peak Hour		SAT Peak Hour		
		Delay (sec/veh)	LOS	Delay (sec/veh)	LOS	Delay (sec/veh)	LOS	
1	Oldham Pkwy. & Ward Road	Signalized	18.3	B	17.0	B	17.6	B
2	Oldham Pkwy. & Jefferson Street	NB	14.5	B	12.7	B	13.5	B
		SB	10.9	B	10.3	B	10.4	B
		EBL	9.3	A	8.8	A	8.9	A
		WBL	12.0	B	9.9	A	10.2	B
3	M-291 & Oldham Parkway	Signalized	28.6	C	64.1	E	59.9	E
4	Persels Road & Jefferson Street	Signalized	46.0	D	44.7	D	46.9	D
5	M-291 & Persels Rd./ Bailey Rd.	Signalized	34.7	C	62.1	E	44.5	D
6	Oldham Parkway & Access 1	EBR	12.5	B	12.6	B	13.1	B
7	Oldham Parkway & Access 2	Signalized	8.5	A	7.9	A	8.8	A
8	Oldham Parkway & Access 3	NBL	7.6	A	7.7	A	7.6	A
		SBL	7.8	A	7.6	A	7.6	A
		EB	10.0	B	10.2	A	9.9	A
		WB	13.4	B	12.8	B	12.2	B
9	Oldham Parkway & Access 4	NB	10.0	A	10.1	B	9.7	A
		WBL	7.6	B	7.6	A	7.5	A
10	Oldham Parkway & Access 5	NB	10.1	B	10.0	B	9.7	A
		WBL	7.6	A	7.6	A	7.5	A
11	Jefferson Street & Public Street	SBL	7.7	A	7.6	A	7.6	A
		WB	15.3	C	11.4	B	11.6	B
12	Jefferson Street & Access 10	SBL	7.7	A	7.6	A	7.6	A
		WB	10.9	B	9.4	B	9.4	B
13	Jefferson Street & Access 6	NBL	8.7	A	7.6	A	7.5	A
		SBL	7.8	A	7.7	A	7.8	A
		EB	17.2	C	12.0	B	12.6	B
		WB	13.3	C	12.1	B	13.1	B
14	Jefferson Street & Access 7	SBL	8.0	A	7.8	A	7.9	A
		WB	12.4	B	10.6	B	11.0	B
15	Oldham Parkway & Access 8	NBR	9.9	A	9.7	A	10.0	A

6.0 CONCLUSIONS AND RECOMMENDATIONS

A traffic impact study for the Oldham Village development has been prepared by Kimley-Horn. The proposed site is generally located in the southwest quadrant of the US-50 and M-291 interchange in Lee's Summit, Missouri. The purpose of this study was to assess the impact of the proposed development on the surrounding transportation system. The following provides a summary of the analysis.

Intersection capacity analysis was performed at the study intersections for the following scenarios:

- Existing Conditions
- Existing + Phase 1 Development Conditions
- Existing + Full Development Conditions
- Future Conditions

All study intersections were found to currently be operating at acceptable levels of service. Some long queues were observed at several locations that exceed the exiting storage length of the turn lanes.

The proposed development is projected to generate 17,291 daily trips, 1,775 AM peak hour trips, 1,324 PM peak hour trips, and 2,026 Saturday peak hour trips. These trips represent primary trips generated by the site, and do not include pass-by trips. During the PM peak hour, the proposed trip generation is slightly higher than what was assumed in the interchange analysis prepared by MoDOT in 2015. The PM peak hour is the critical time period for analysis of the study area. Therefore, the analysis performed by MoDOT in 2015 is still valid for the interchange and the interchange was not evaluated in this study.

The proposed Oldham Village development is anticipated to be constructed in two phases. Phase 1 includes the realignment of Oldham Parkway through the northern portion of the site. A portion of Jefferson Street will also be realigned to the west to create greater separation from M-291. The Phase 1 portion of the site will be accessed from six driveway intersections with public streets. Phase 1 includes several restaurants and a large building for fitness and athletic events.

Phase 2 includes an apartment building in the southwest corner of Oldham Parkway & Jefferson Street. A number of pad sites are also proposed east of Jefferson Street in Phase 2. The Phase 2 portion will be accessed primarily from four intersections along Jefferson Street, one access along Oldham Parkway, and one access along Persels Road.

The proposed accesses along Oldham are generally spaced appropriately. Two of the accesses have throats that are shorter than required, but all queues are projected to be contained within the throat lengths. On Jefferson Street, the proposed accesses do not meet the minimum spacing requirements from the *Access Management Code*. However, all of the accesses are projected to operate acceptably, and all queues are projected to be contained within the available throat lengths.

Several improvements are shown on the site plan or have been identified in this study to mitigate the addition of Phase 1 development site traffic and achieve acceptable operations. These improvements are listed below:

Oldham Parkway & M-291

- Construct an eastbound left-turn lane with a minimum storage length of 350 feet plus taper.
- Construct a second eastbound left turn lane. This lane will extend at least 300 feet west of Jefferson Street plus taper.
- Construct an eastbound right-turn lane with a minimum storage length of 350 feet plus taper.
- Construct two westbound lanes on Oldham Parkway, extending east of the intersection. The right lane should terminate as a right-turn lane at Access 2, and the left lane will continue as the through lane.

Oldham Parkway & Jefferson Street

- Construct a raised median on Oldham Parkway to restrict Jefferson Street access to left-in/right-in/right-out.
- Construct an eastbound left-turn lane with a minimum storage length of 150 feet plus taper.
- Construct a westbound left-turn lane with a minimum storage length of 200 feet plus taper.

Oldham Parkway & Access 2

- Install a traffic signal.
- Construct a northbound left-turn lane with a minimum storage length of 150 feet plus taper.
- Construct a southbound left-turn lane with a minimum storage length of 150 feet plus taper.
- Construct the eastbound and westbound approaches with three lanes, to provide one inbound lane and two outbound lanes.

Oldham Parkway & Access 3

- Construct a northbound left-turn lane with a minimum storage length of 150 feet plus taper. This will require moving the access farther to the north to allow for a 150-foot southbound left-turn lane to be constructed at Access 2.

Jefferson Street

- Construct the realigned portion of Jefferson Street as a three-lane roadway with a center two-way left-turn lane.

Signal installation is recommended for the Oldham Parkway & Drive 2 intersection because it will be the most efficient form of control for vehicles, the Four-Hour Warrant is expected to be satisfied, and signalization will provide the safest form of control for pedestrians crossing Oldham Parkway.

Additional improvements are identified for Phase 2 of the development. These improvements are listed below:

Oldham Parkway & M-291

- Lengthen the southbound right-turn lane to provide a minimum storage length of 300 feet plus taper.

Persels Road & M-291

- *Construct an eastbound right-turn lane with a minimum storage length of 150 feet plus taper.*

Persels Road & Market Street

- Construct a raised median on Persels Road to restrict Market Street access to right-in/right-out.

Persels Road & Gas Station Access

- Construct a westbound right-turn lane with a minimum storage length of 150 feet plus taper.

Future Conditions were also analyzed to determine the need for capacity improvements within the study network. Additional improvements were identified for the future at the M-291 & Persels Road intersection, such as three southbound through lanes dual north/south left-turn lanes, and two east/west through lanes. The signalized intersections along M-291 are projected to operate at LOS E during the PM and Saturday peak hour. Additional improvements will be needed to achieve acceptable levels of service at these intersections if the future volumes projected in this study are realized.

APPENDIX

Appendix A: EXHIBITS

Appendix B: TURNING MOVEMENT COUNTS

Appendix C: SITE PLAN

Appendix D: ITE TRIP GENERATION MANUAL SHEETS

Appendix E: SYNCHRO REPORTS

Appendix F: SIGNAL WARRANT ANALYSIS

Appendix A: Exhibits

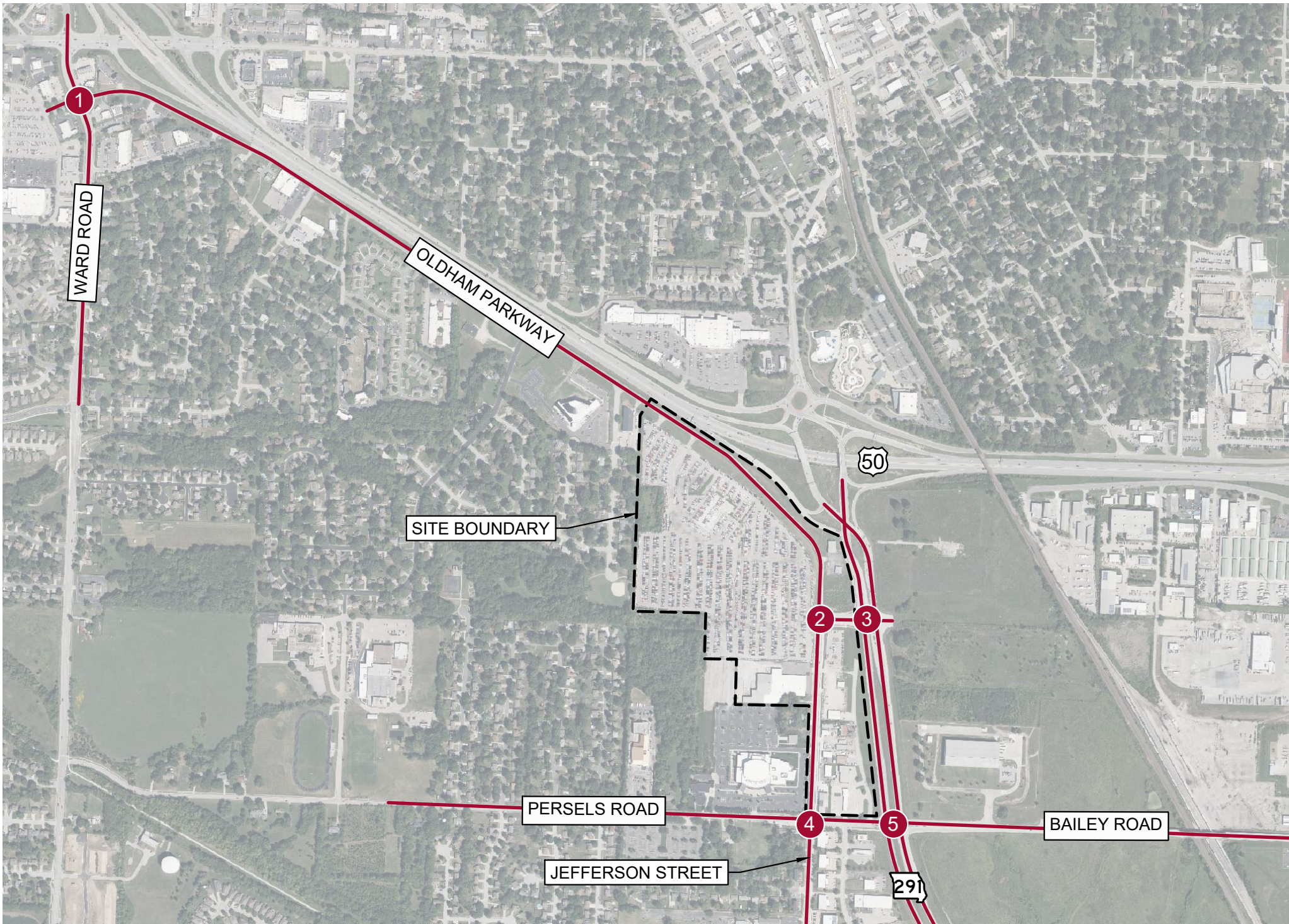

Oldham Parkway & Ward Road

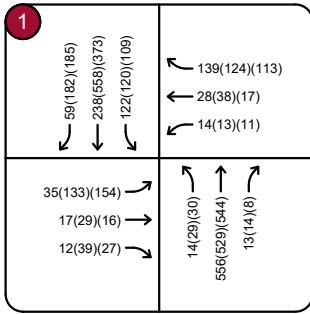

Oldham Parkway & Jefferson Street

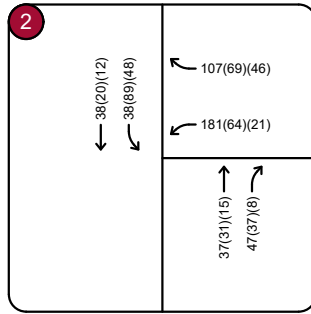

M-291 & Oldham Parkway

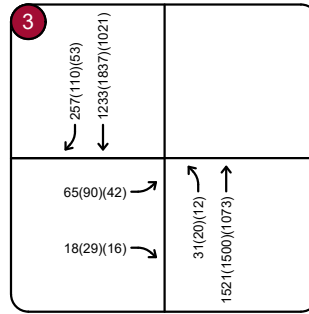

Persels Road & Jefferson Street

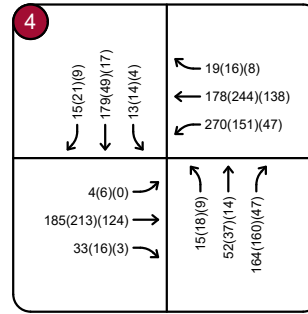

M-291 & Persels Road/Bailey Road

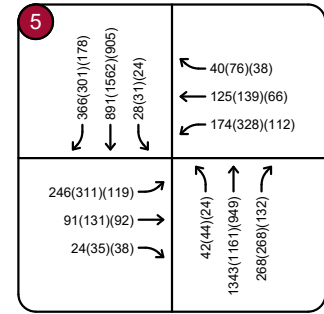

LEGEND	
XX(XX)(XX)	AM(PM)(SAT) TRAFFIC VOLUMES

Oldham Parkway & Ward Road

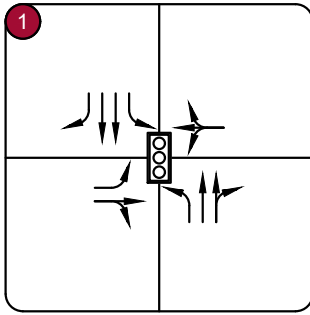

Oldham Parkway & Jefferson Street

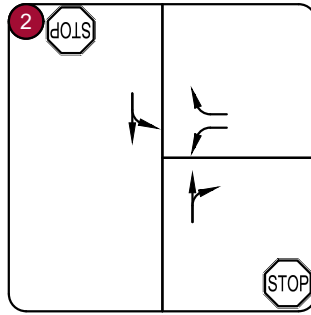

M-291 & Oldham Parkway

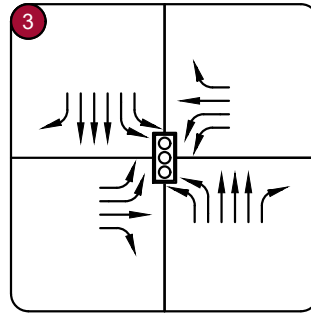

Persels Road & Jefferson Street

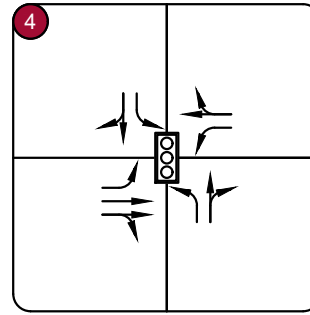

M-291 & Persels Road/Bailey Road

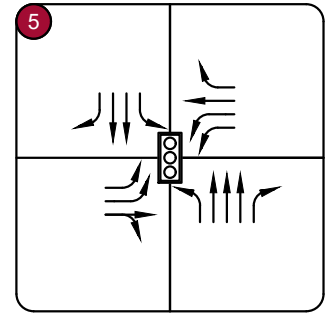

Oldham Parkway &
Ward Road

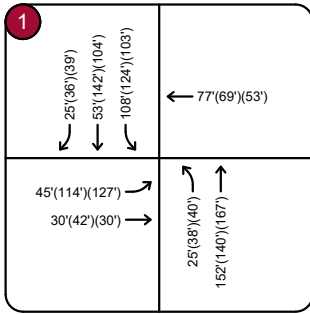

Oldham Parkway &
Jefferson Street

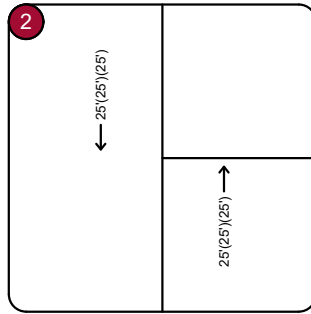

M-291 & Oldham Parkway

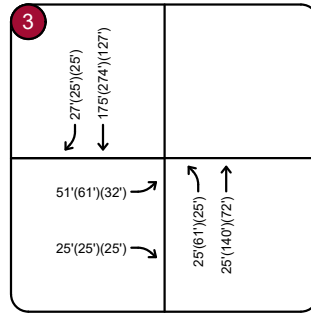

Persels Road &
Jefferson Street

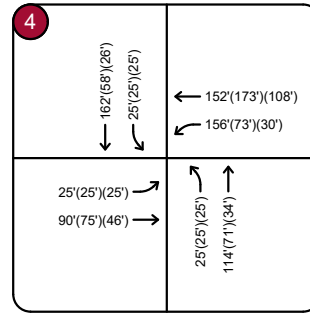

M-291 & Persels
Road/Bailey Road

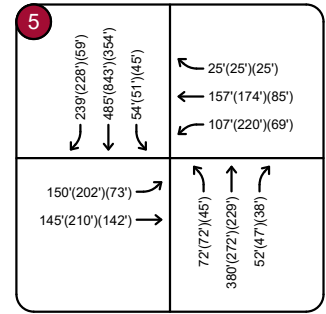

LEGEND

XX'(XX')(XX') AM(PM)(SAT) QUEUE LENGTHS (FEET)

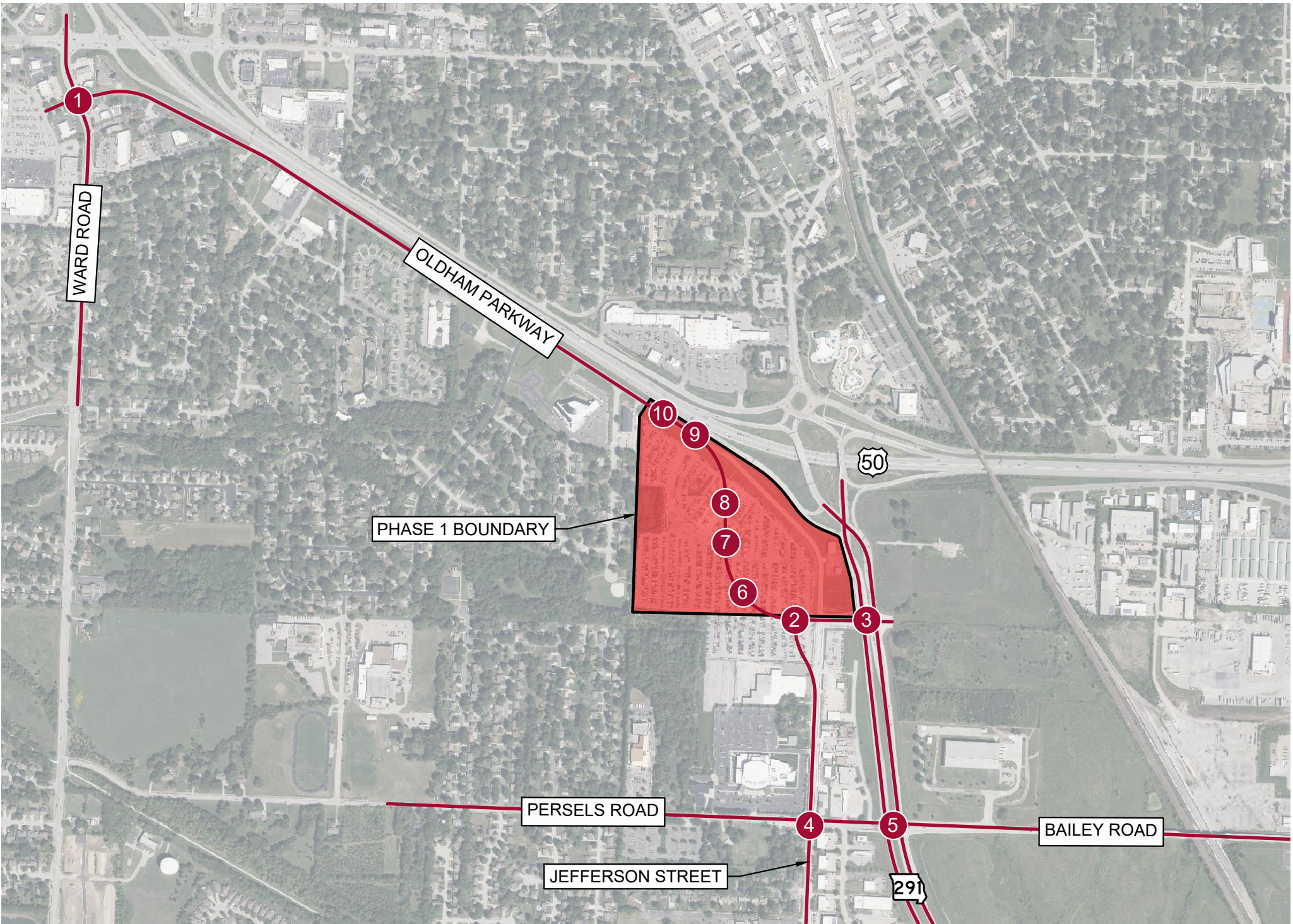

1

WARD ROAD

OLDHAM PARKWAY

PHASE 1 BOUNDARY

10

9

8

7

6

2

50

3

PERSELS ROAD

4

5

BAILEY ROAD

JEFFERSON STREET

291

Oldham Parkway & Ward Road

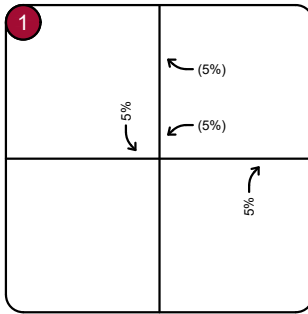

Oldham Parkway & Jefferson Street

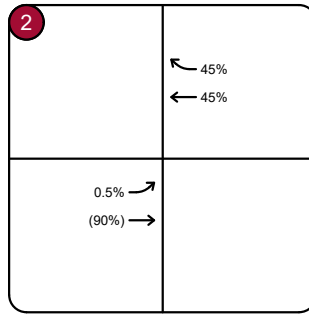

M-291 & Oldham Parkway

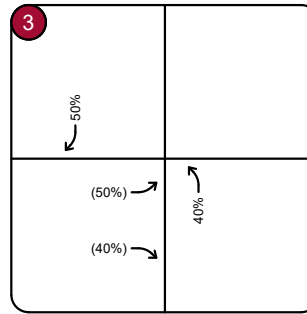

Persels Road & Jefferson Street

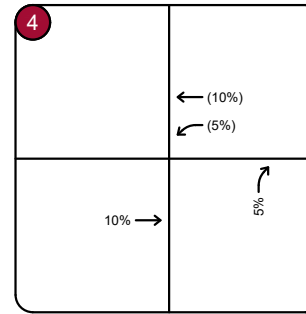

M-291 & Persels Road/Bailey Road

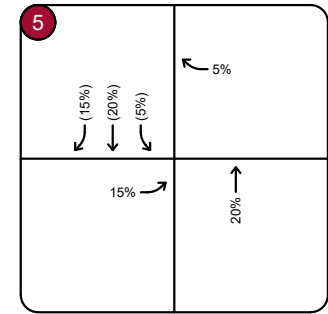

Oldham Parkway & Access 1

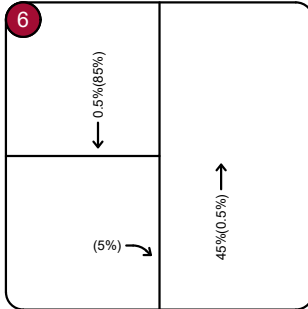

Oldham Parkway & Access 2

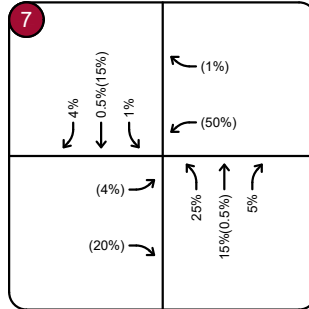

Oldham Parkway & Access 3

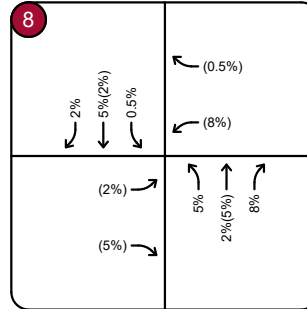

Oldham Parkway & Access 4

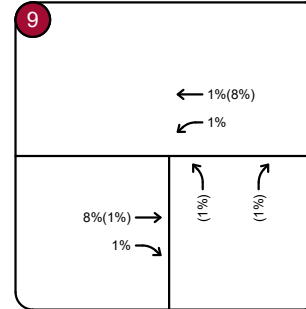

Oldham Parkway & Access 5

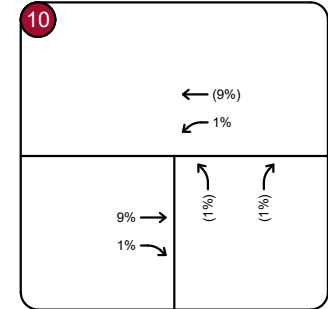

LEGEND

X%
(X%)

INBOUND SITE TRAFFIC
OUTBOUND SITE TRAFFIC

Oldham Parkway & Ward Road

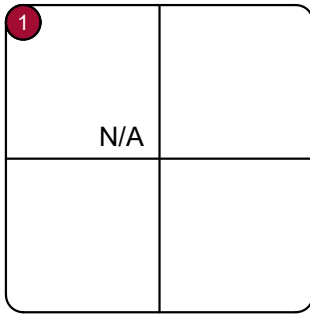

Oldham Parkway & Jefferson Street

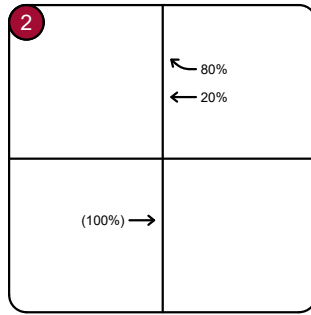

M-291 & Oldham Parkway

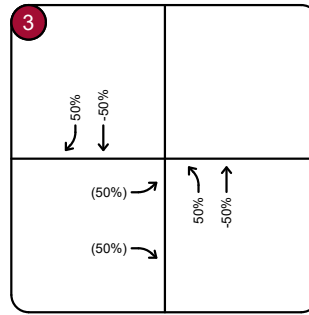

Persels Road & Jefferson Street

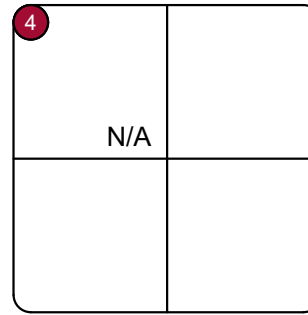

M-291 & Persels Road/Bailey Road

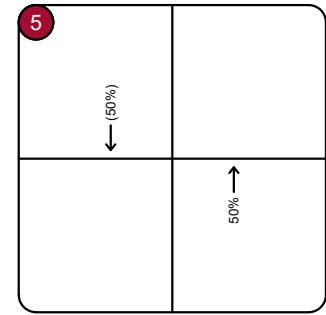

Oldham Parkway & Access 1

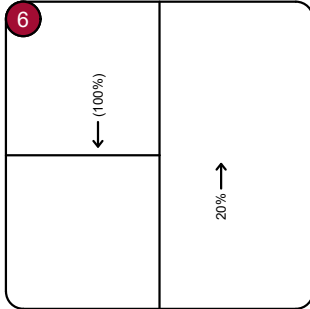

Oldham Parkway & Access 2

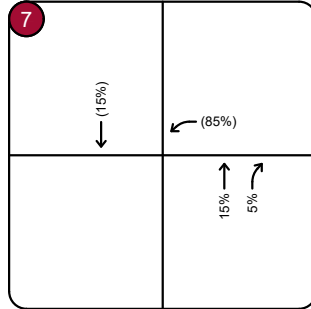

Oldham Parkway & Access 3

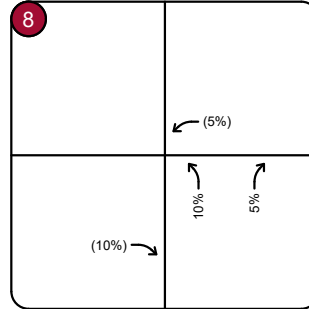

Oldham Parkway & Access 4

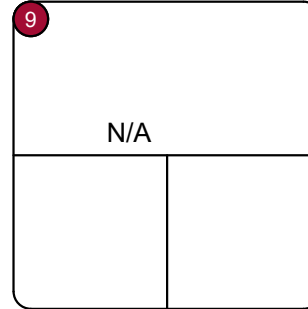

Oldham Parkway & Access 5

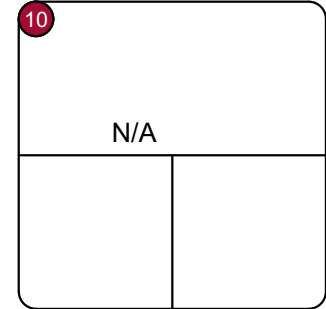

LEGEND

X% INBOUND SITE TRAFFIC
 (X%) OUTBOUND SITE TRAFFIC

Oldham Parkway & Ward Road

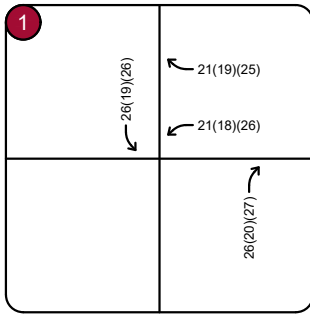

Oldham Parkway & Jefferson Street

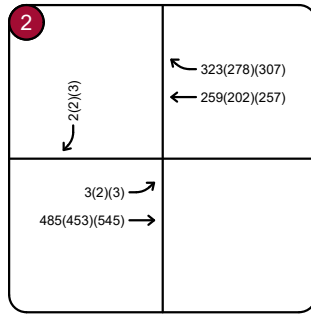

M-291 & Oldham Parkway

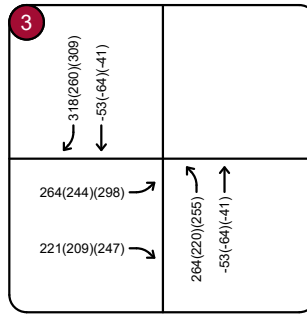

Persels Road & Jefferson Street

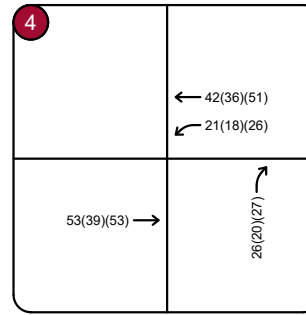

M-291 & Persels Road/Bailey Road

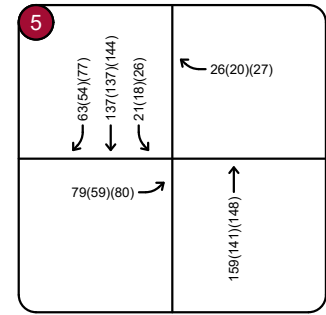

Oldham Parkway & Access 1

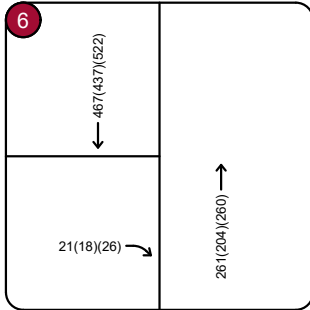

Oldham Parkway & Access 2

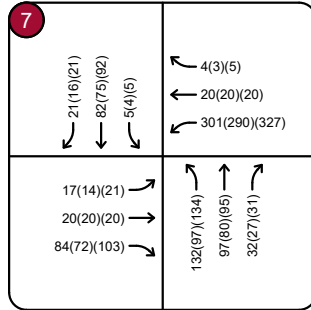

Oldham Parkway & Access 3

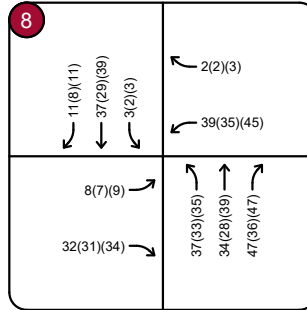

Oldham Parkway & Access 4

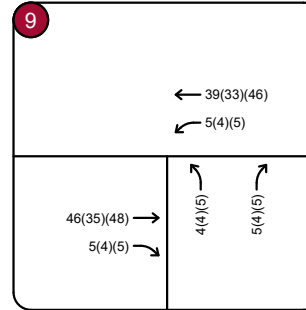

Oldham Parkway & Access 5

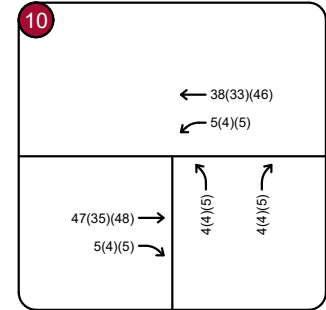

LEGEND

XX(X)(XX)

AM(PM)(SAT) TRAFFIC VOLUMES



Oldham Parkway & Ward Road

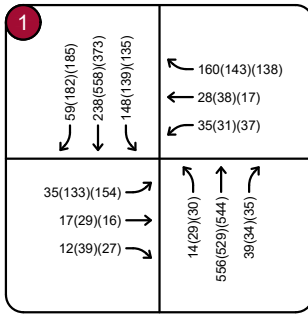

Oldham Parkway & Jefferson Street

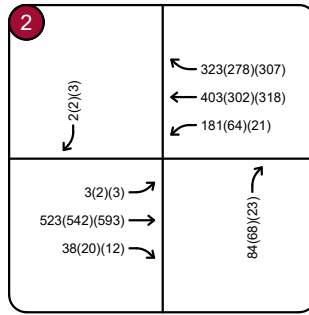

M-291 & Oldham Parkway

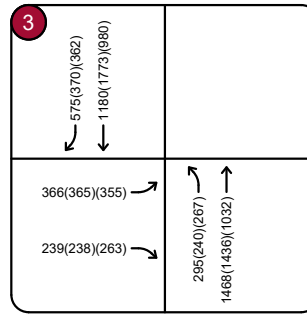

Persels Road & Jefferson Street

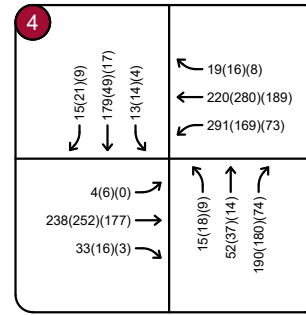

M-291 & Persels Road/Bailey Road

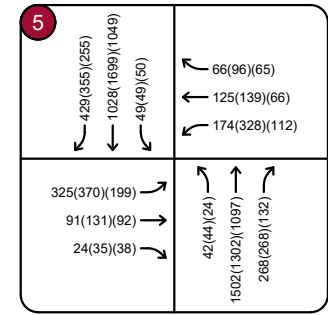

Oldham Parkway & Access 1

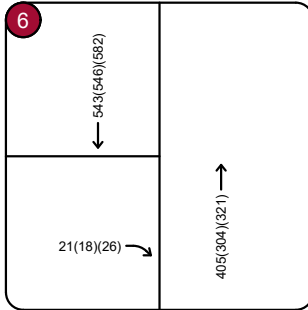

Oldham Parkway & Access 2

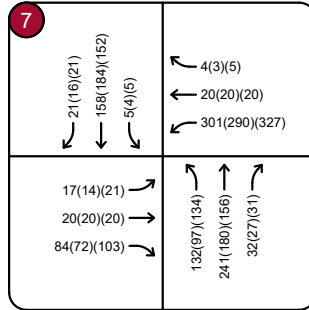

Oldham Parkway & Access 3

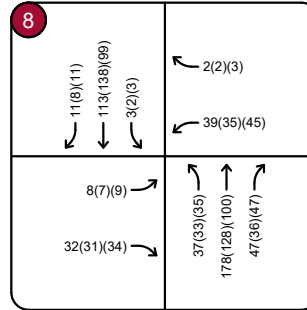

Oldham Parkway & Access 4

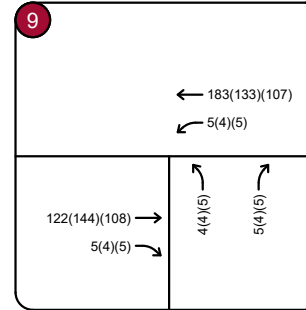

Oldham Parkway & Access 5

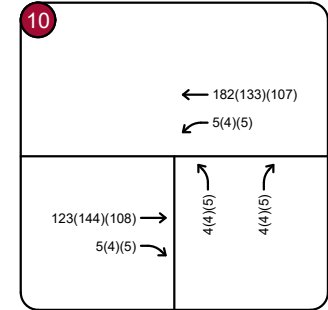

LEGEND

XX(X)(XX)

AM(PM)(SAT) TRAFFIC VOLUMES

Oldham Parkway & Ward Road

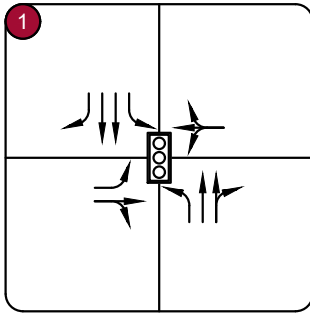

Oldham Parkway & Jefferson Street

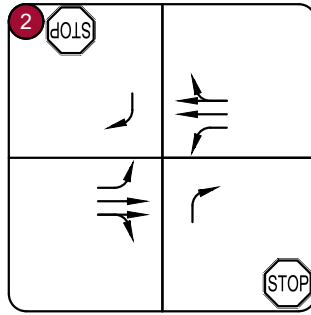

M-291 & Oldham Parkway

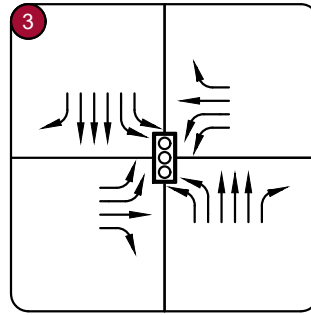

Persels Road & Jefferson Street

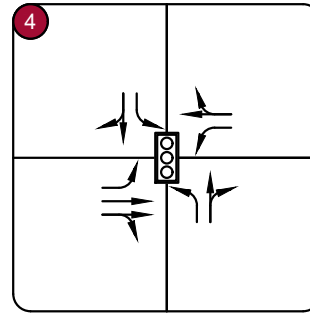

M-291 & Persels Road/Bailey Road

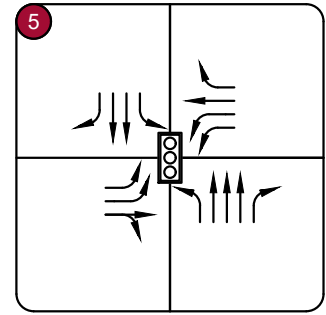

Oldham Parkway & Access 1

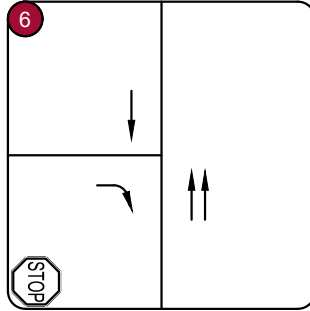

Oldham Parkway & Access 2

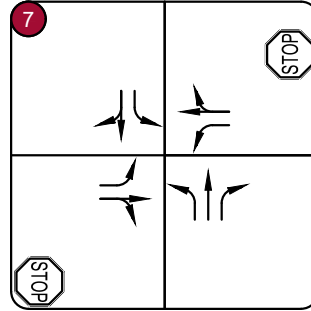

Oldham Parkway & Access 3

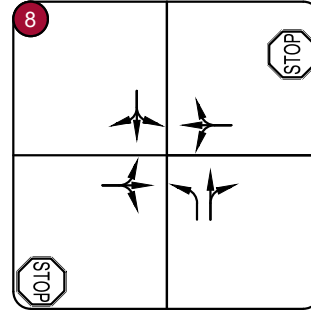

Oldham Parkway & Access 4

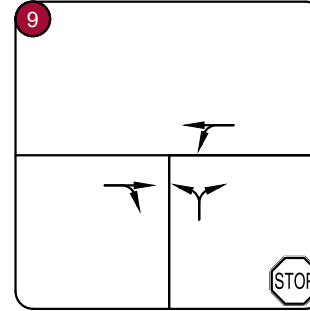

Oldham Parkway & Access 5

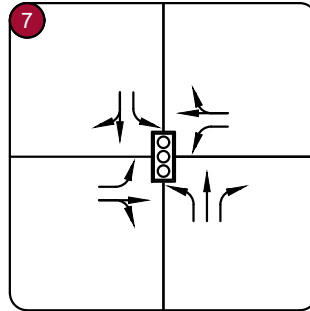
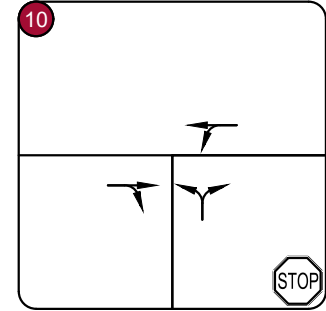

MITIGATION

Oldham Parkway & Ward Road

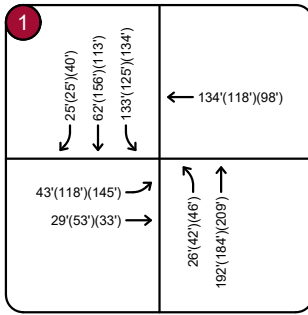

Oldham Parkway & Jefferson Street

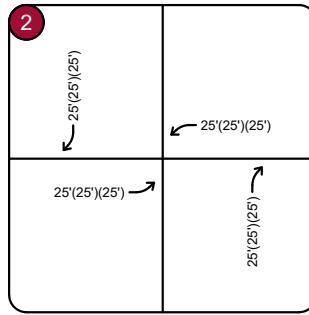

M-291 & Oldham Parkway

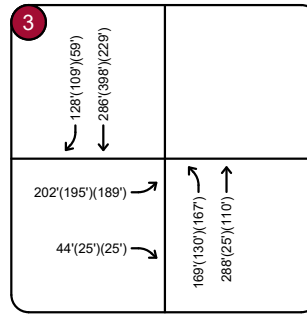

Persels Road & Jefferson Street

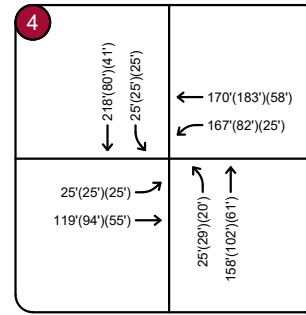

M-291 & Persels Road/Bailey Road

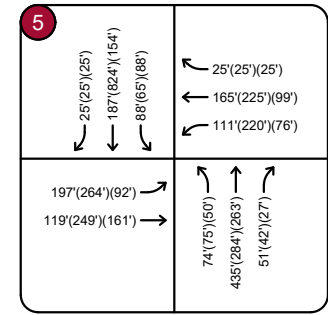

Oldham Parkway & Access 1

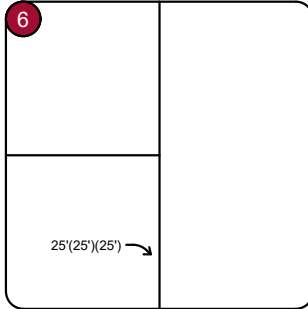

Oldham Parkway & Access 2

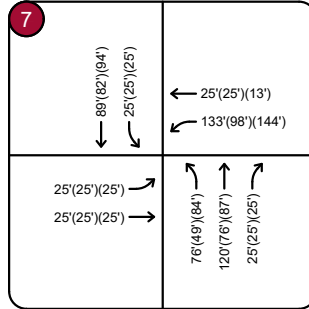

Oldham Parkway & Access 3

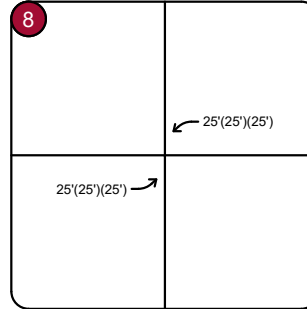

Oldham Parkway & Access 4

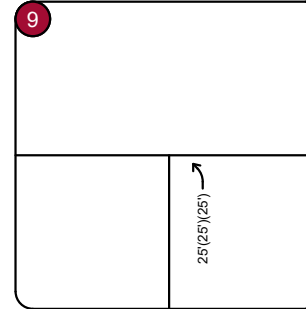

Oldham Parkway & Access 5

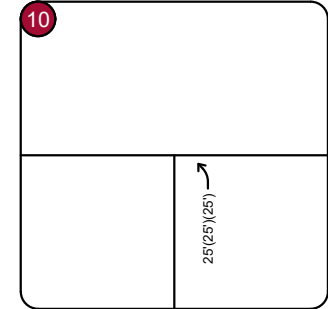

LEGEND

XX'(XX')(XX') AM(PM)(SAT) QUEUE LENGTHS (FEET)

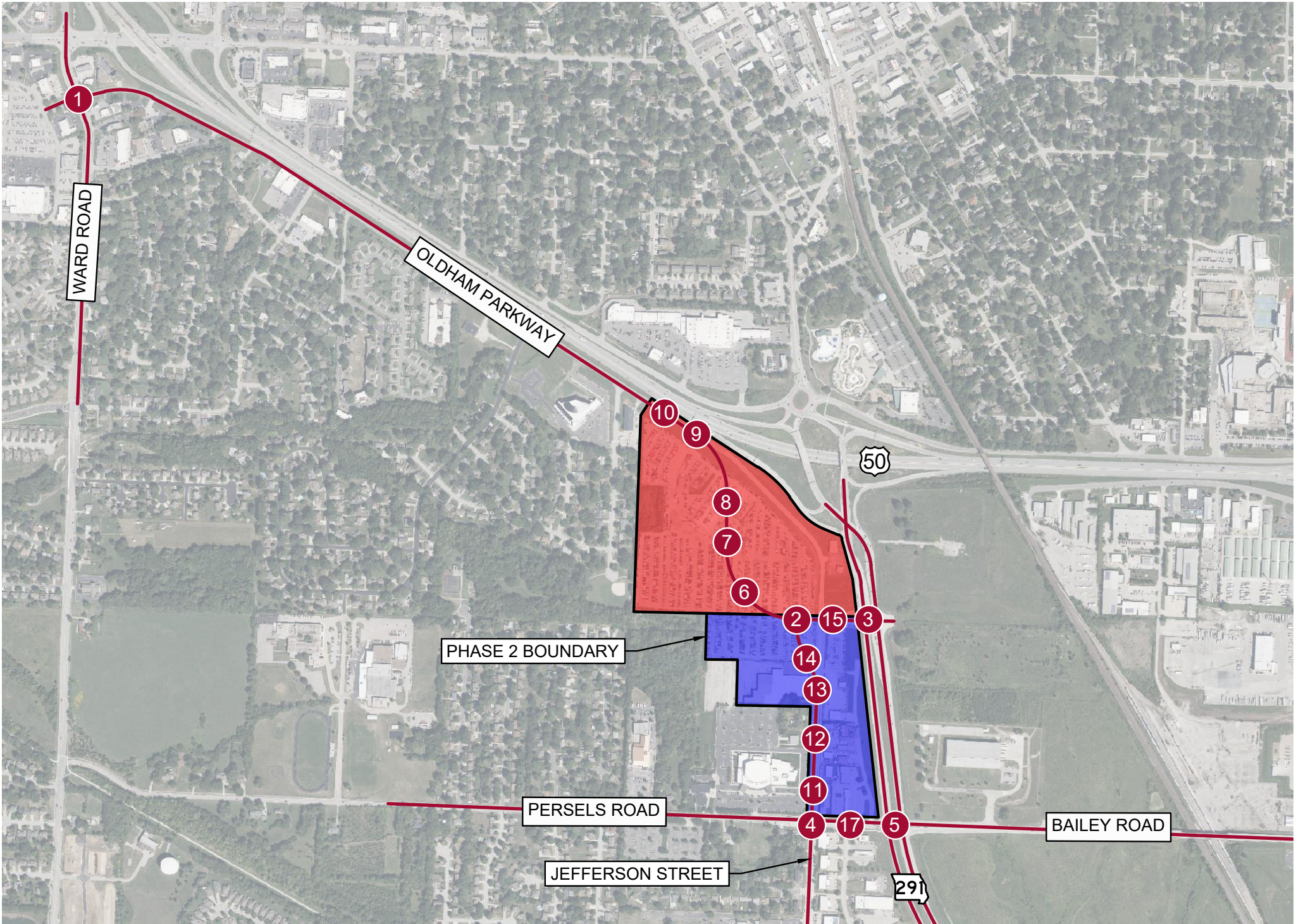

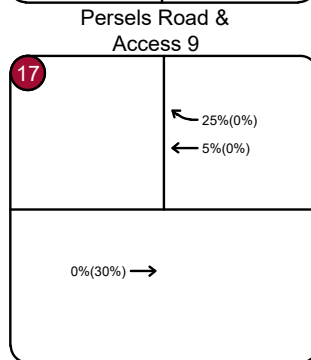
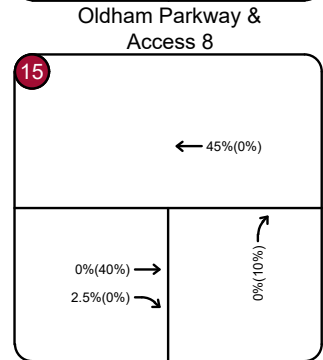
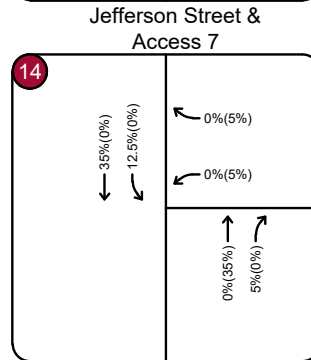
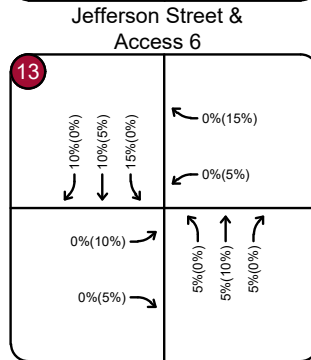
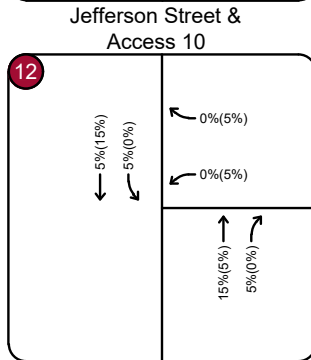
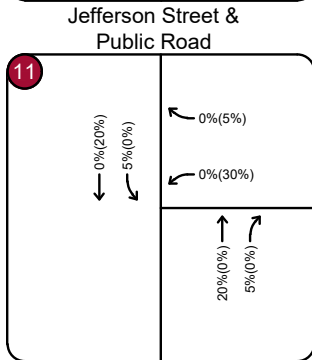
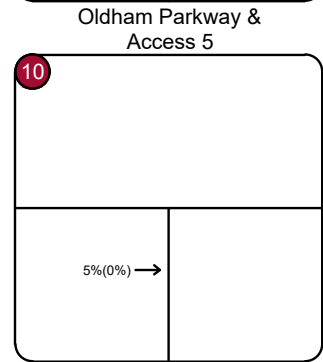
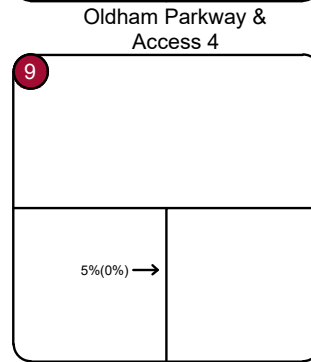
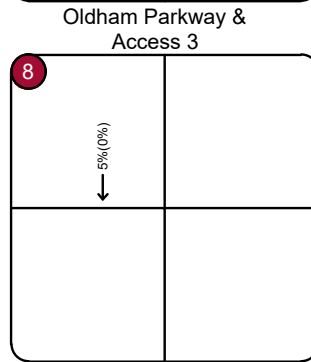
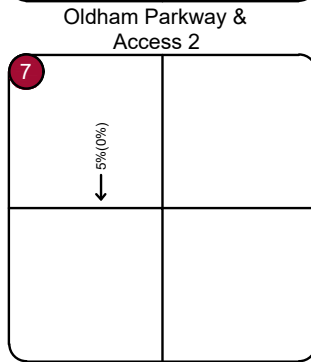
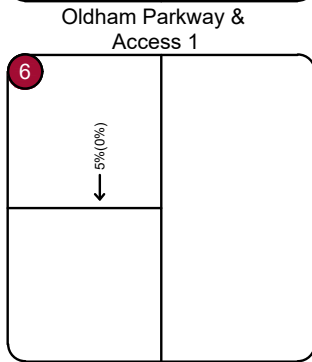
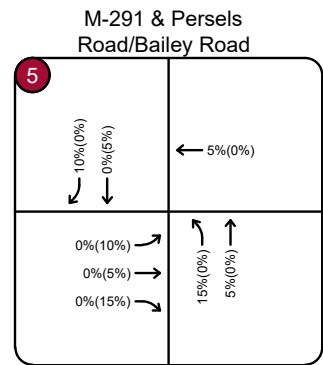
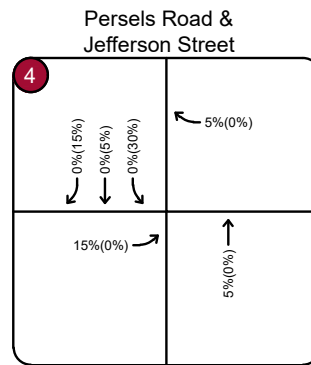
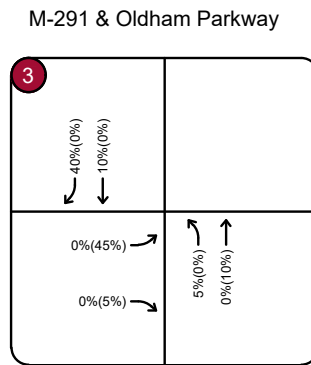
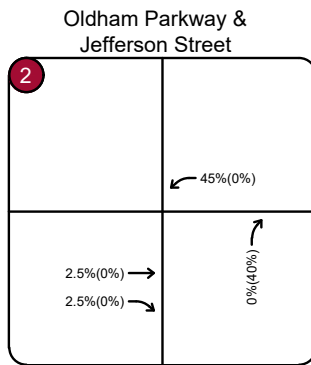
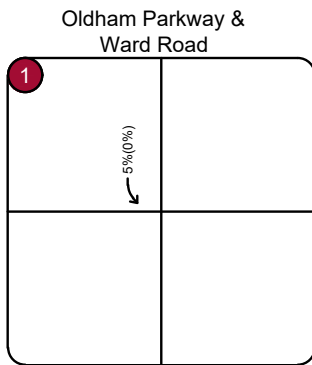

LEGEND	
X%	INBOUND SITE TRAFFIC
(X%)	OUTBOUND SITE TRAFFIC

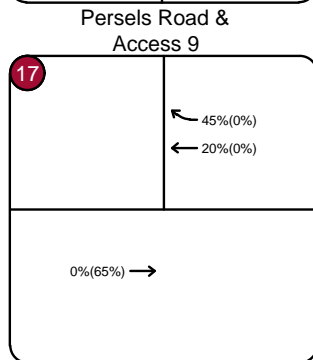
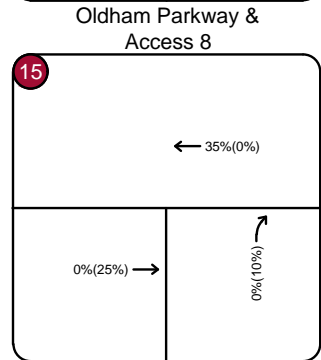
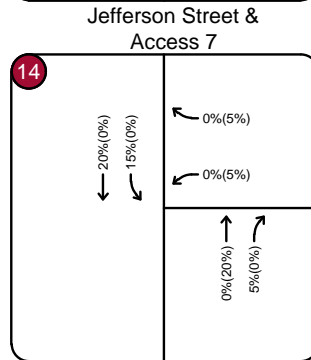
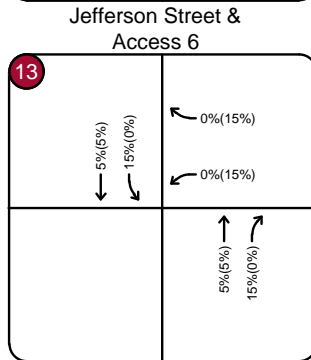
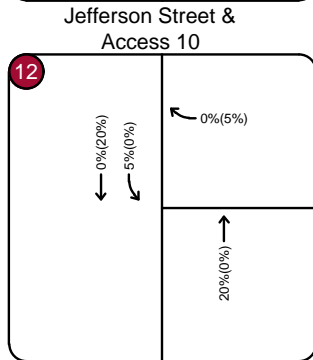
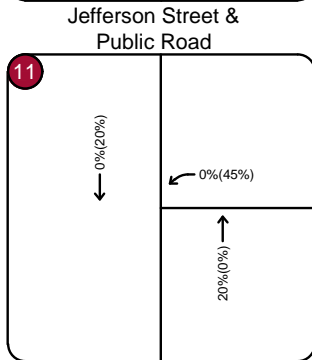
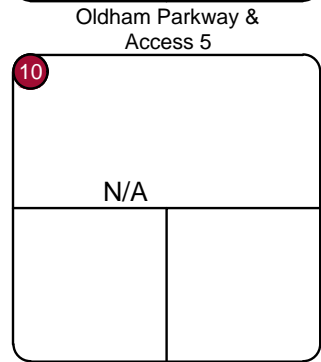
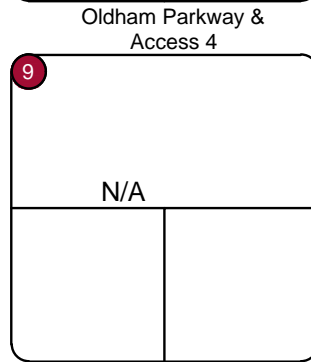
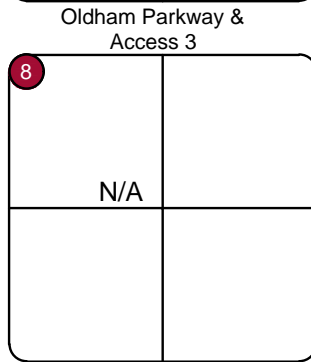
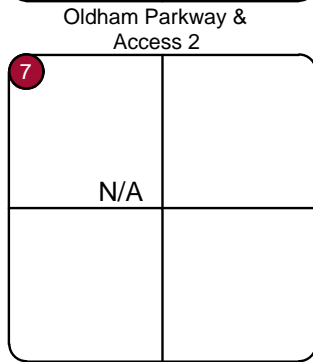
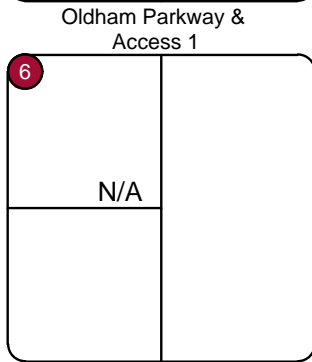
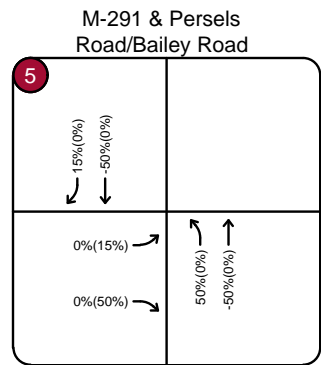
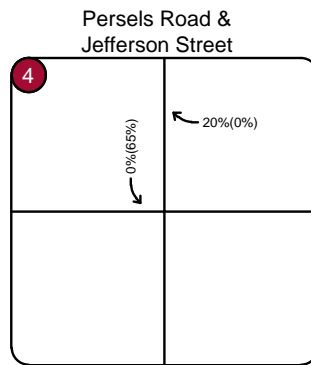
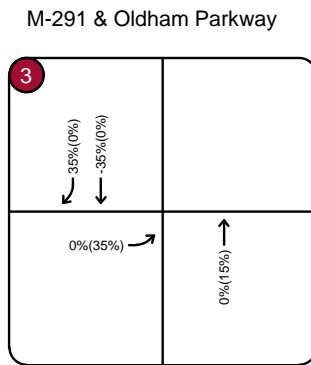
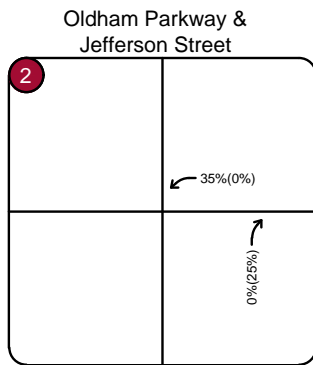
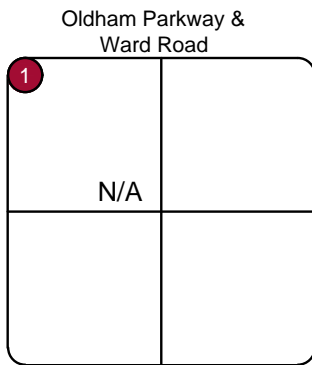

LEGEND	
X%	INBOUND SITE TRAFFIC
(X%)	OUTBOUND SITE TRAFFIC

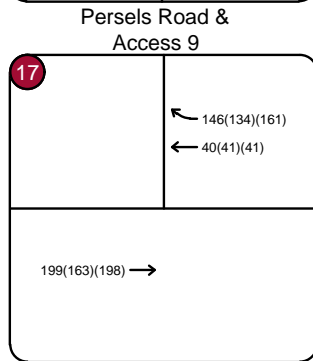
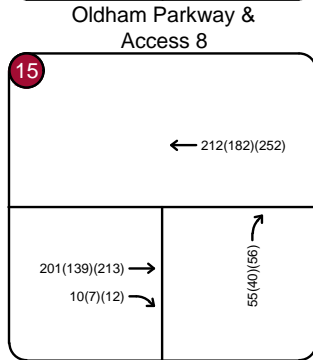
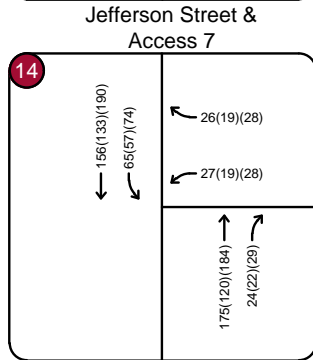
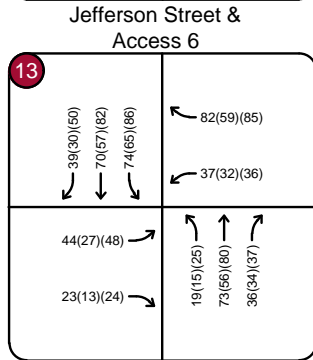
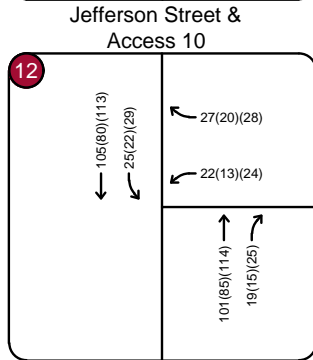
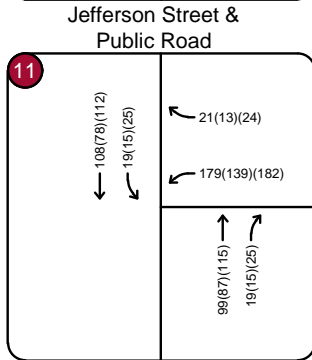
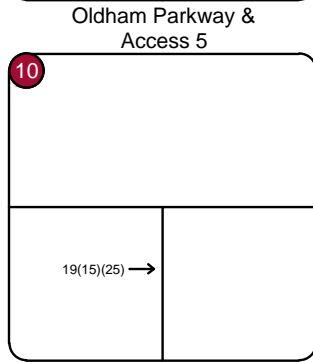
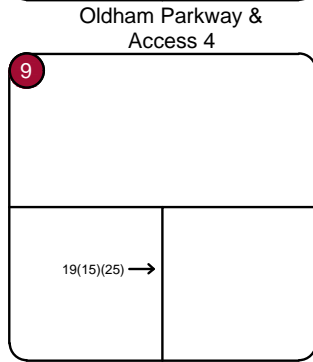
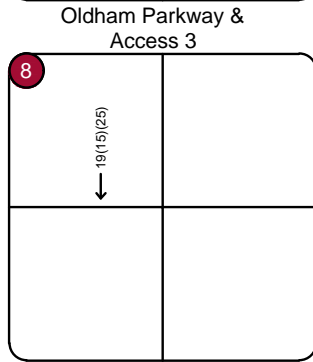
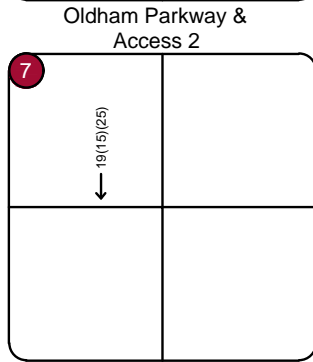
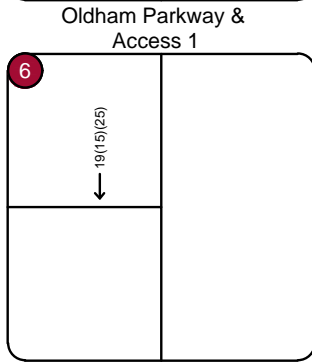
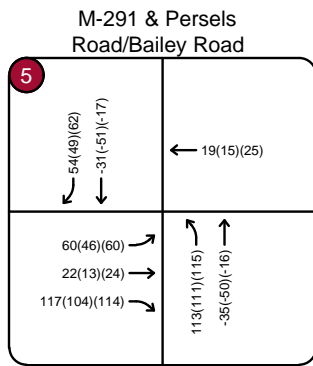
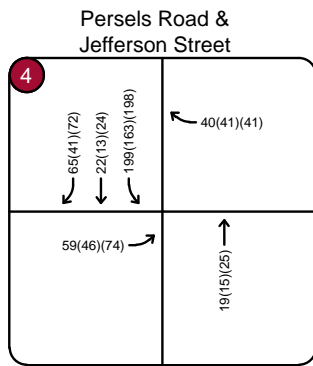
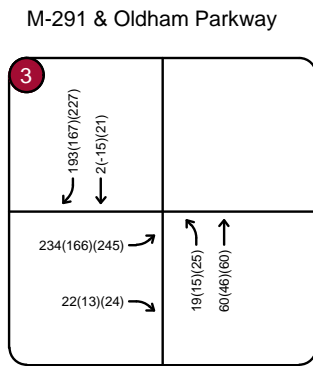
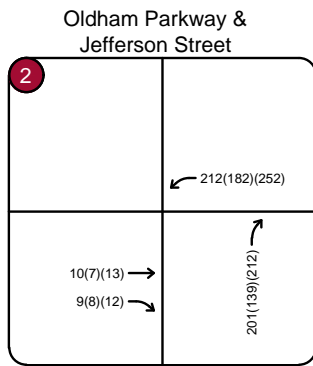
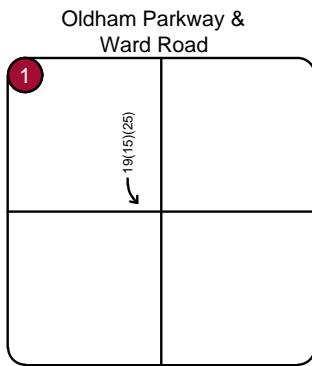

LEGEND	
XX(X)(X)	AM(PM)(SAT) TRAFFIC VOLUMES

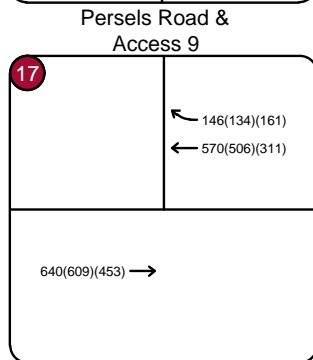
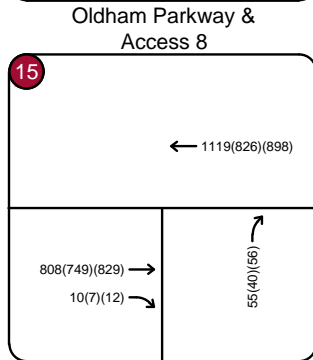
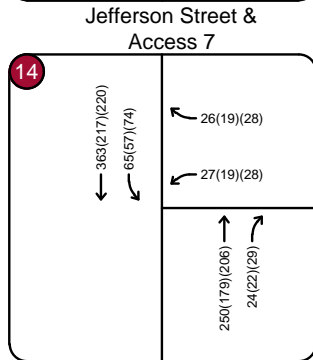
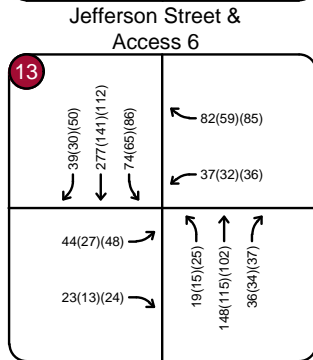
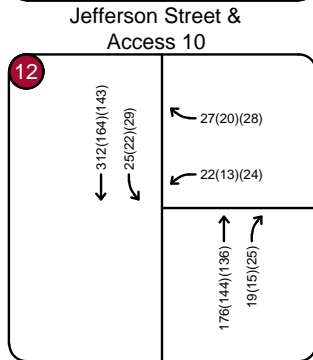
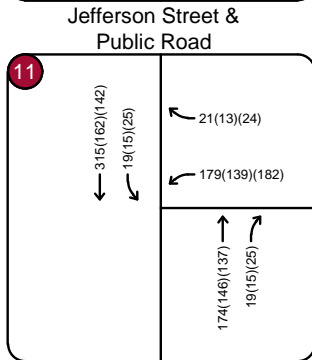
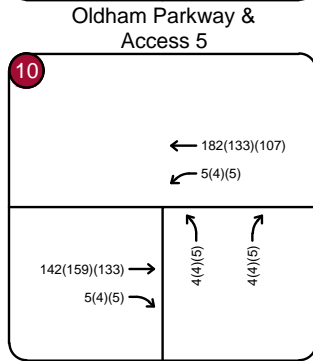
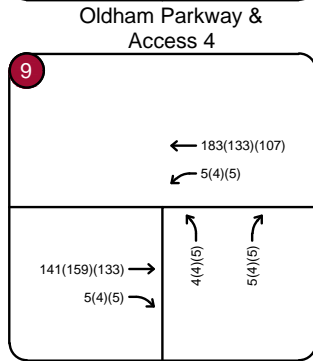
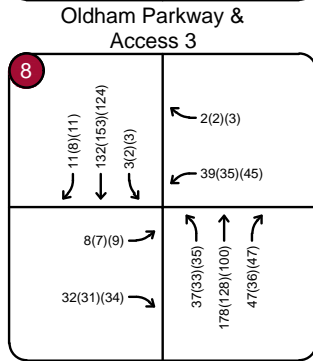
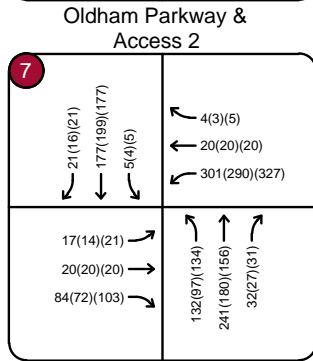
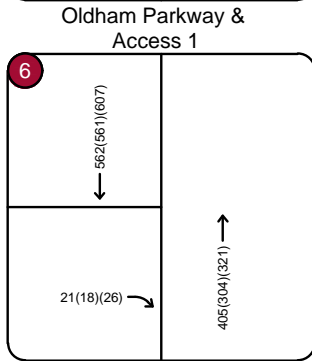
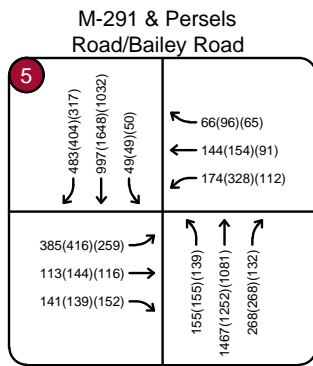
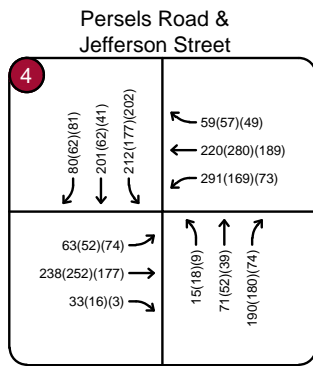
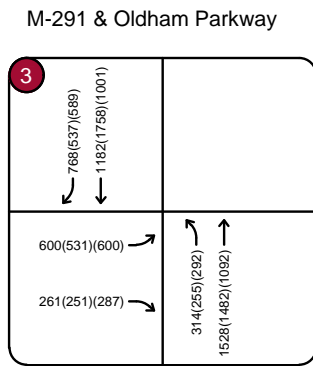
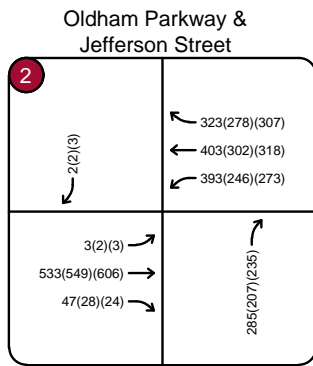
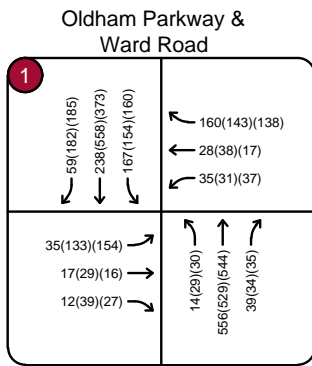

LEGEND

XX(XX)(XX) AM(PM)(SAT) TRAFFIC VOLUMES

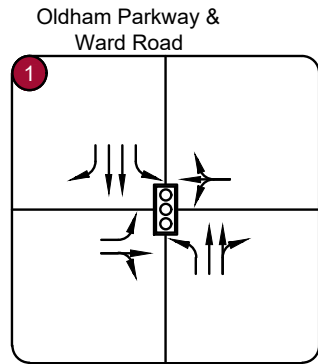

Oldham Parkway & Access 1

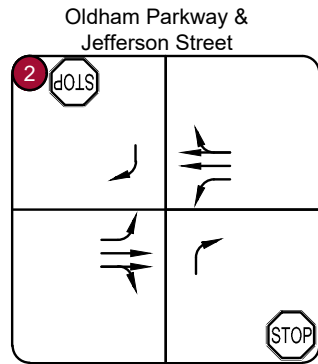

Oldham Parkway & Access 2

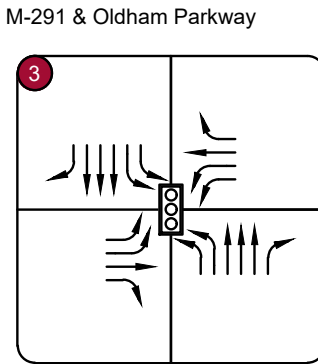

Oldham Parkway & Access 3

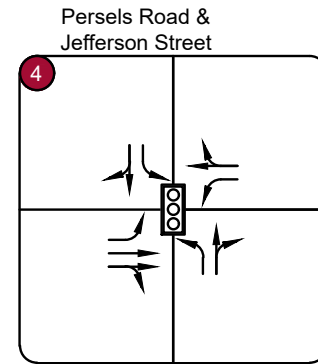

Oldham Parkway & Access 4

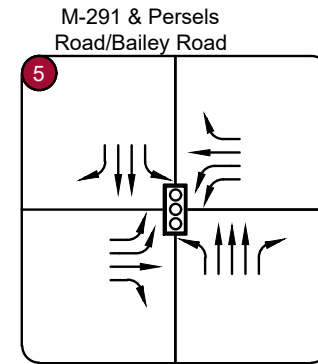

Oldham Parkway & Access 5

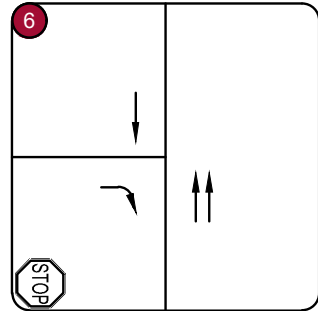

Jefferson Street & Public Road

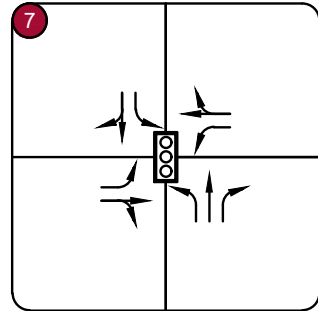

Jefferson Street & Access 10

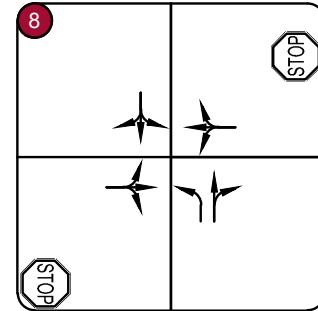

Jefferson Street & Access 6

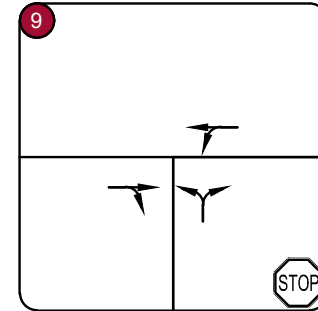

Jefferson Street & Access 7

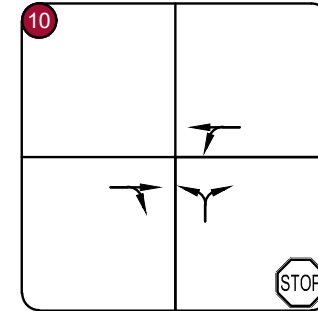

Oldham Parkway & Access 8

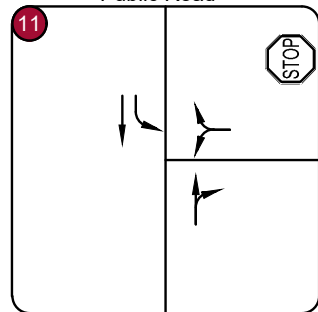

Persels Road & Access 9

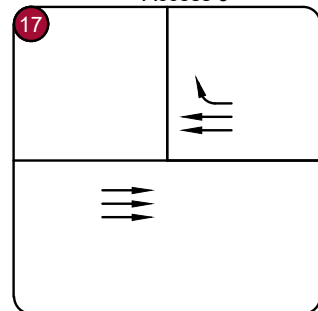
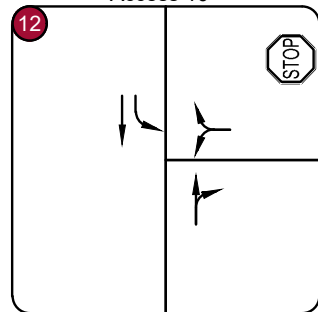

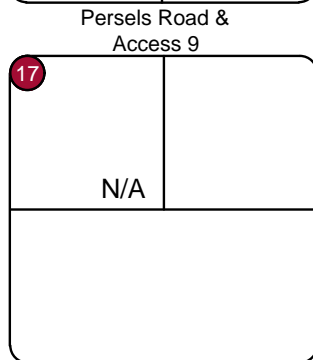
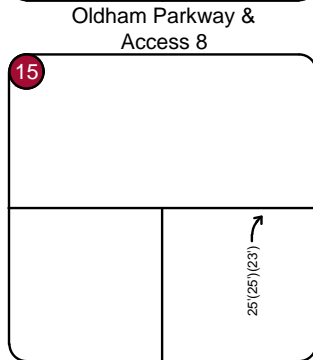
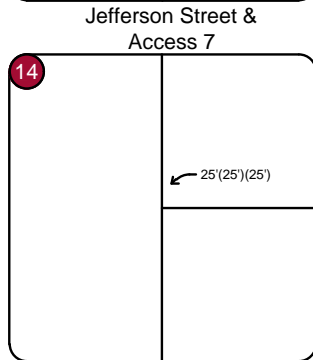
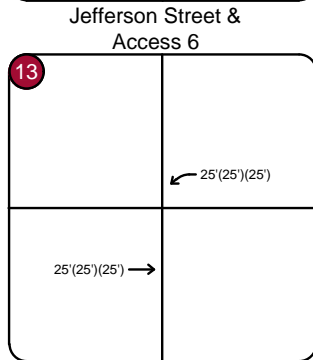
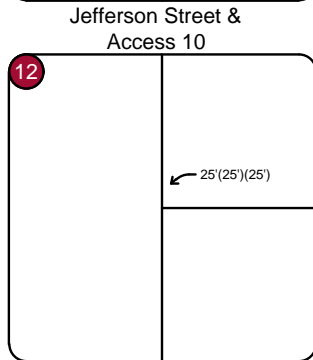
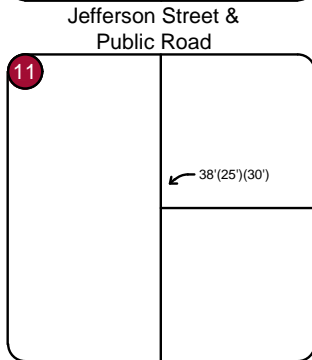
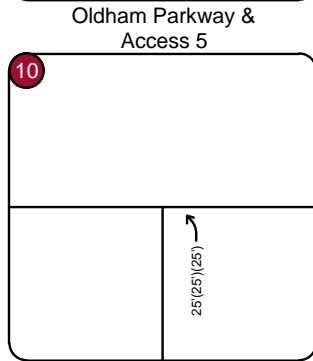
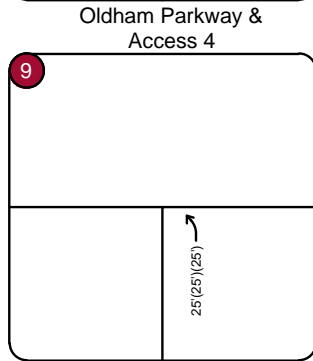
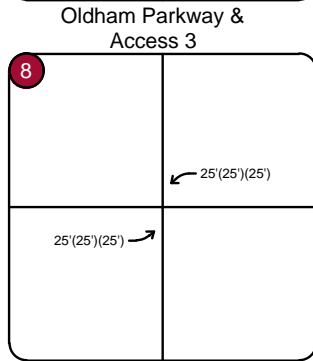
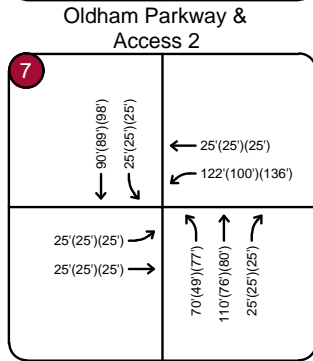
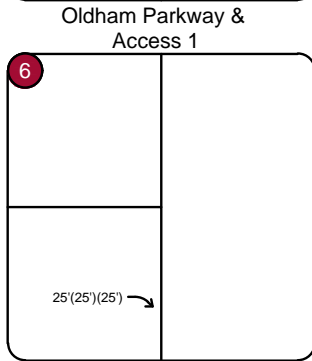
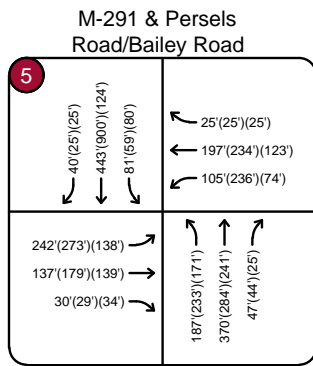
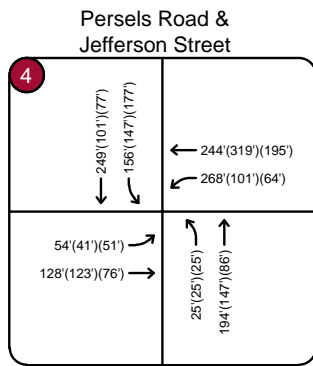
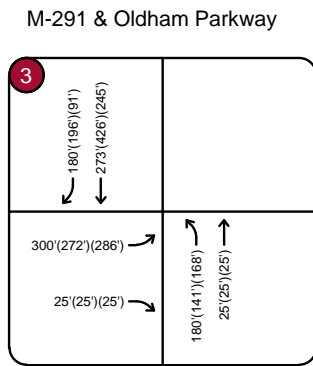
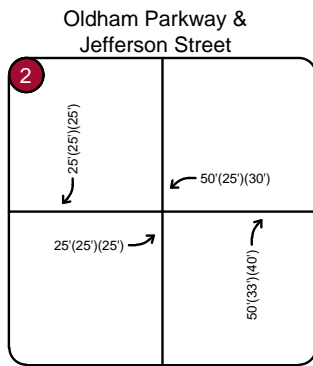
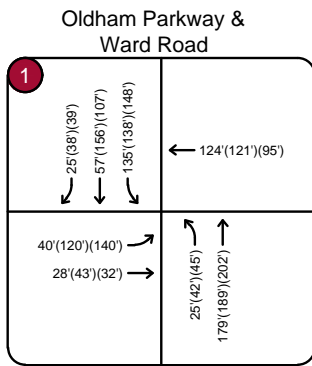

LEGEND

XX'(XX')(XX') AM(PM)(SAT) QUEUE LENGTHS (FEET)

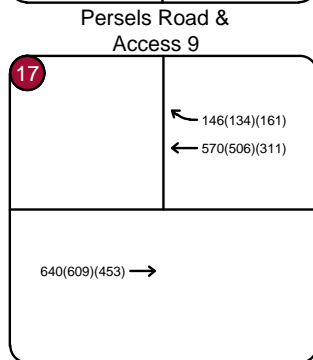
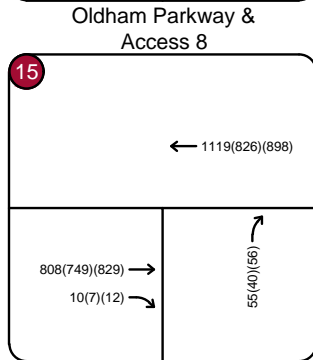
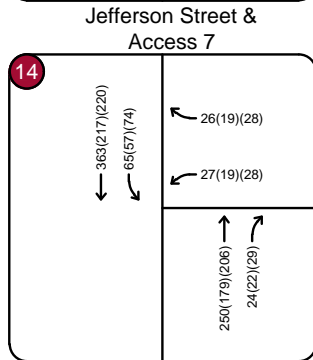
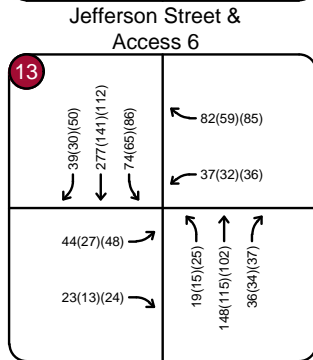
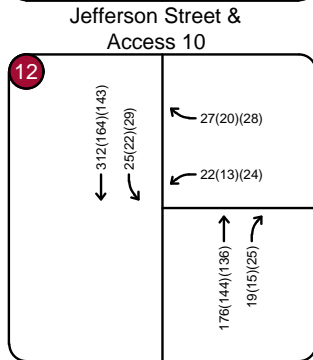
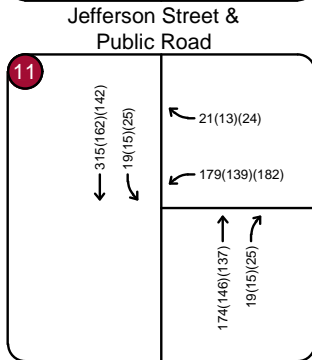
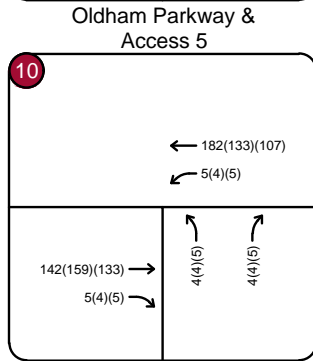
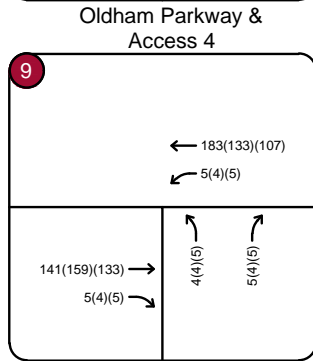
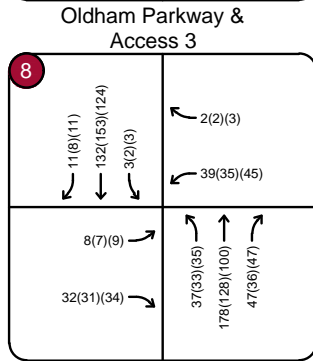
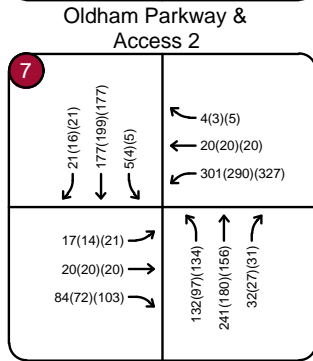
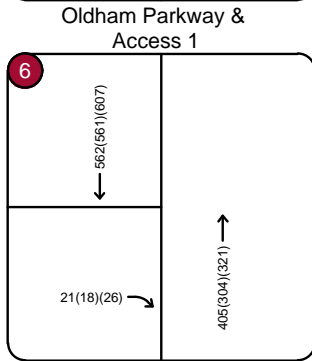
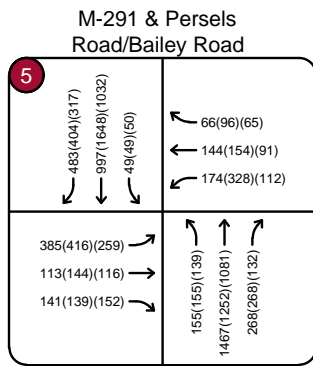
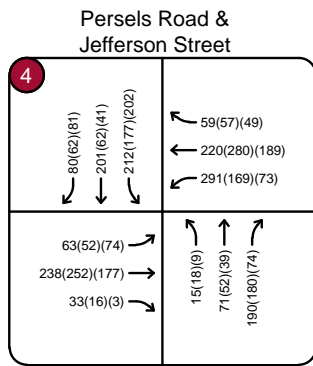
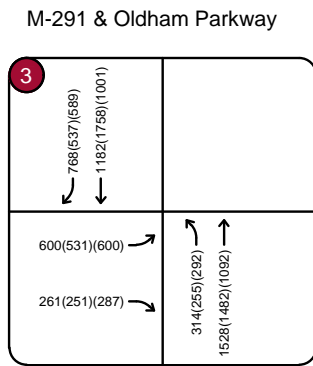
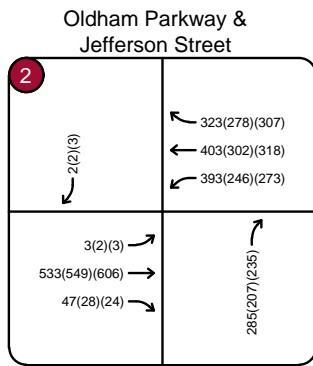
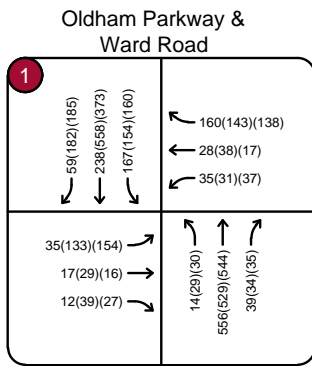

LEGEND

XX(X)(X) AM(PM)(SAT) TRAFFIC VOLUMES

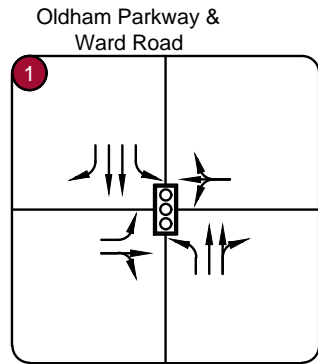

Oldham Parkway & Ward Road

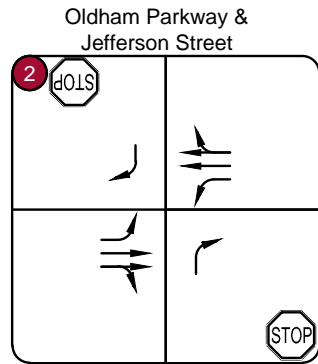

Oldham Parkway & Jefferson Street

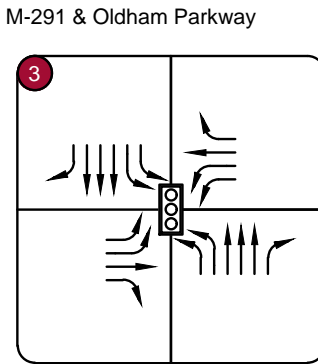

M-291 & Oldham Parkway

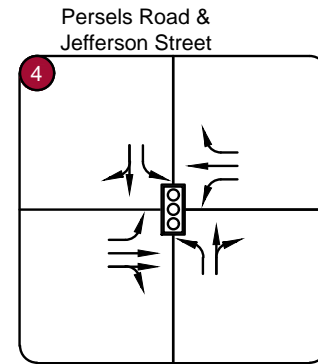

Persels Road & Jefferson Street

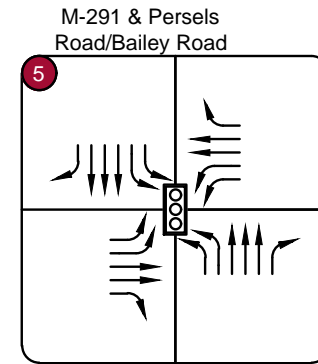

M-291 & Persels Road/Bailey Road

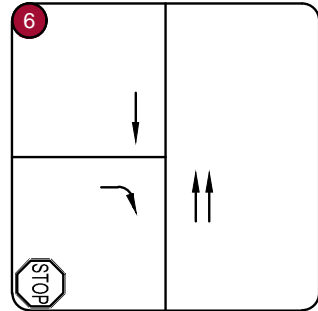

Oldham Parkway & Access 1

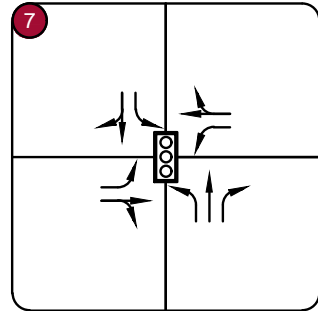

Oldham Parkway & Access 2

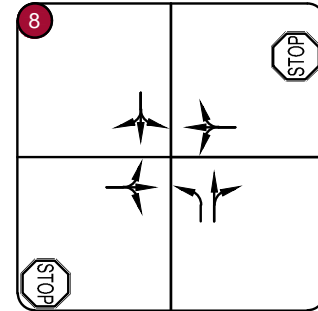

Oldham Parkway & Access 3

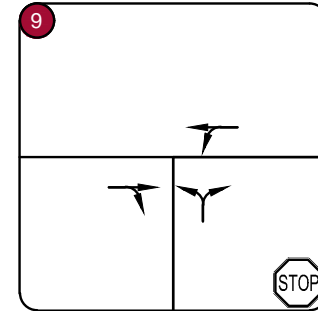

Oldham Parkway & Access 4

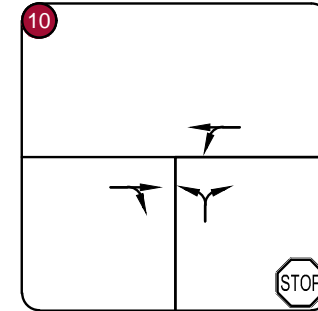

Oldham Parkway & Access 5

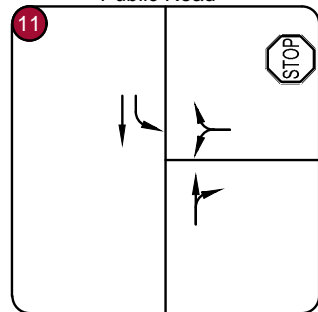

Jefferson Street & Public Road

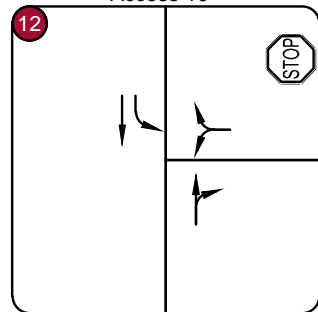

Jefferson Street & Access 10

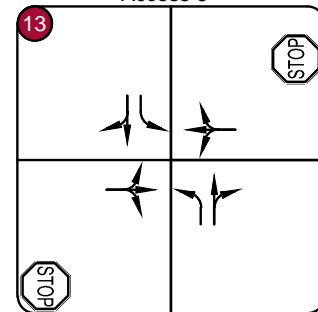

Jefferson Street & Access 6

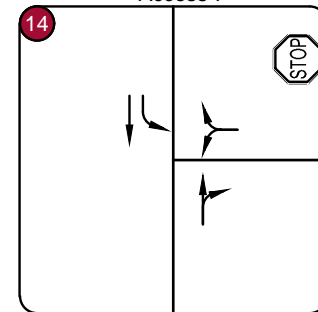

Jefferson Street & Access 7

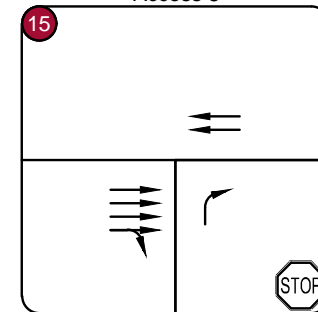

Oldham Parkway & Access 8

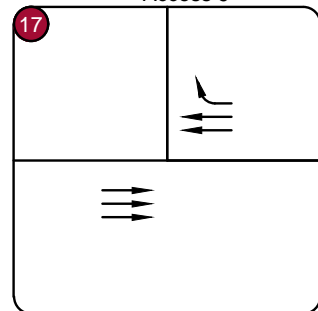

Persels Road & Access 9

Oldham Parkway & Ward Road

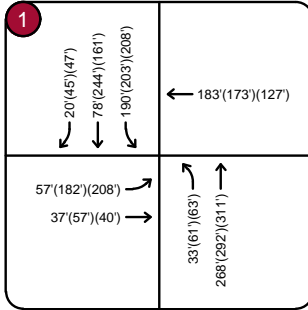

Oldham Parkway & Access 1

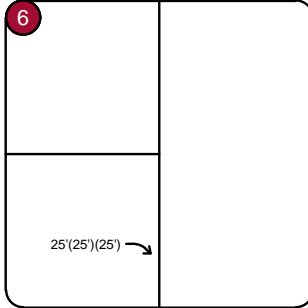

Jefferson Street & Public Road

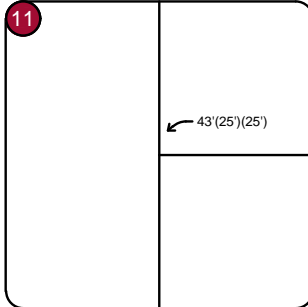

Oldham Parkway & Jefferson Street

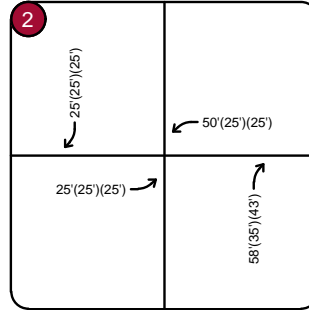

Oldham Parkway & Access 2

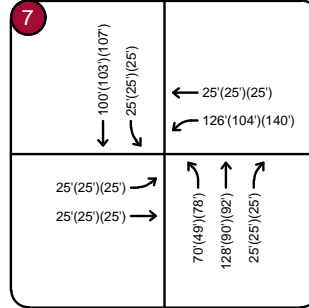

Jefferson Street & Access 10

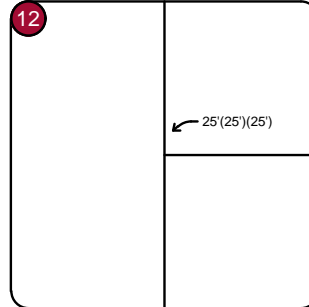

Persels Road & Access 9

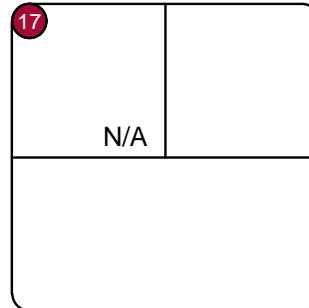

M-291 & Oldham Parkway

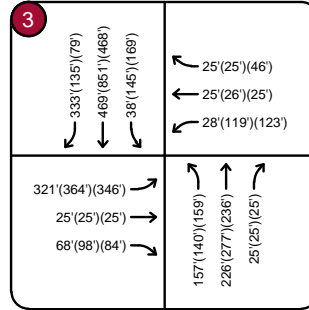

Oldham Parkway & Access 3

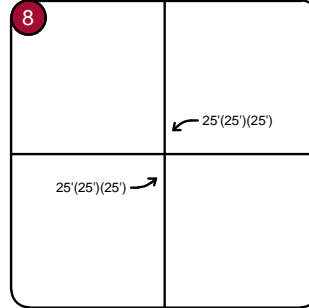

Jefferson Street & Access 6

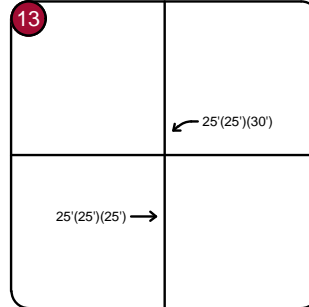

Persels Road & Jefferson Street

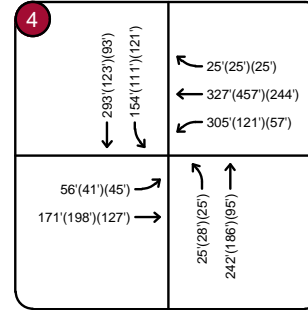

Oldham Parkway & Access 4

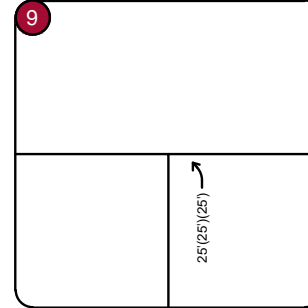

Jefferson Street & Access 7

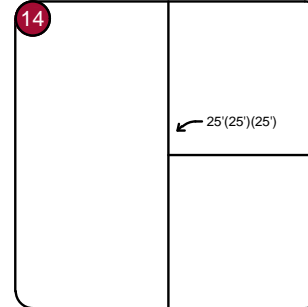

M-291 & Persels Road/Bailey Road

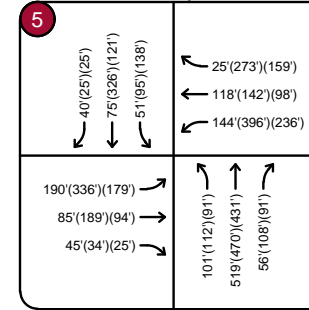

Oldham Parkway & Access 5

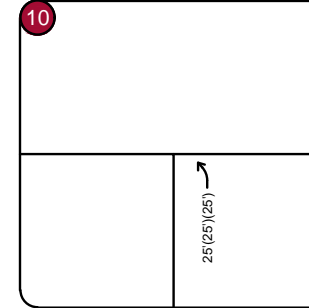

Oldham Parkway & Access 8

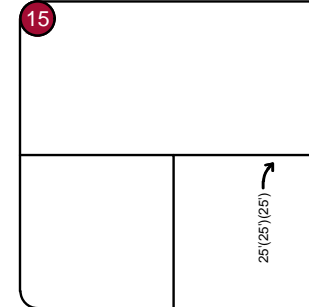

LEGEND

XX'(XX')(XX') AM(PM)(SAT) QUEUE LENGTHS (FEET)



Appendix B: Turning Movement Counts

Oldham Pkwy & Ward Rd - TMC

Thu Oct 20, 2022

Full Length (7 AM-9 AM, 4 PM-6 PM)

All Classes (Lights, Articulated Trucks, Buses and Single-Unit Trucks)

All Movements

ID: 1001818, Location: 38.910111, -94.395544



Provided by: Gewalt Hamilton Associates Inc.

625 Forest Edge Drive, Vernon Hills, IL, 60061, US

Leg Direction	Access Eastbound					Oldham Pkwy Westbound					Ward Rd Northbound					Ward Rd Southbound					Int
	L	T	R	U	App	L	T	R	U	App	L	T	R	U	App	L	T	R	U	App	
2022-10-20 7:00AM	4	0	6	0	10	0	0	15	0	15	0	115	1	0	116	15	55	8	0	78	219
7:15AM	11	2	2	0	15	0	5	26	0	31	4	142	1	0	147	26	58	11	0	95	288
7:30AM	8	10	2	0	20	6	8	50	0	64	5	145	3	0	153	27	70	10	0	107	344
7:45AM	6	2	2	0	10	4	7	38	0	49	2	122	3	0	127	35	56	17	0	108	294
Hourly Total	29	14	12	0	55	10	20	129	0	159	11	524	8	0	543	103	239	46	0	388	1145
8:00AM	10	3	6	0	19	4	8	25	0	37	3	147	6	0	156	34	54	21	0	109	321
8:15AM	15	5	3	0	23	5	7	40	0	52	3	116	5	0	124	17	51	11	0	79	278
8:30AM	12	2	6	0	20	2	2	21	0	25	3	113	0	0	116	20	47	16	0	83	244
8:45AM	9	3	6	0	18	1	2	26	0	29	4	133	2	0	139	28	68	20	0	116	302
Hourly Total	46	13	21	0	80	12	19	112	0	143	13	509	13	0	535	99	220	68	0	387	1145
4:00PM	40	9	5	0	54	0	10	29	0	39	4	112	1	0	117	28	114	38	0	180	390
4:15PM	43	6	8	0	57	2	12	28	0	42	7	147	4	0	158	38	134	45	0	217	474
4:30PM	25	8	11	0	44	6	12	31	0	49	9	124	3	0	136	25	147	44	0	216	445
4:45PM	37	11	14	0	62	2	7	35	0	44	5	136	3	0	144	25	142	40	0	207	457
Hourly Total	145	34	38	0	217	10	41	123	0	174	25	519	11	0	555	116	537	167	0	820	1766
5:00PM	28	4	6	0	38	3	7	30	0	40	8	122	4	0	134	32	135	53	0	220	432
5:15PM	39	8	8	0	55	8	8	35	0	51	7	134	1	0	142	32	140	52	0	224	472
5:30PM	40	6	4	0	50	2	7	20	0	29	5	145	2	0	152	44	132	51	0	227	458
5:45PM	33	6	6	0	45	4	7	29	0	40	3	129	4	0	136	27	156	40	0	223	444
Hourly Total	140	24	24	0	188	17	29	114	0	160	23	530	11	0	564	135	563	196	0	894	1806
Total	360	85	95	0	540	49	109	478	0	636	72	2082	43	0	2197	453	1559	477	0	2489	5862
% Approach	66.7%	15.7%	17.6%	0%	-	7.7%	17.1%	75.2%	0%	-	3.3%	94.8%	2.0%	0%	-	18.2%	62.6%	19.2%	0%	-	-
% Total	6.1%	1.5%	1.6%	0%	9.2%	0.8%	1.9%	8.2%	0%	10.8%	1.2%	35.5%	0.7%	0%	37.5%	7.7%	26.6%	8.1%	0%	42.5%	-
Lights	359	82	89	0	530	48	108	462	0	618	71	2052	41	0	2164	437	1530	475	0	2442	5754
% Lights	99.7%	96.5%	93.7%	0%	98.1%	98.0%	99.1%	96.7%	0%	97.2%	98.6%	98.6%	95.3%	0%	98.5%	96.5%	98.1%	99.6%	0%	98.1%	98.2%
Articulated Trucks	0	0	0	0	0	0	0	1	0	1	0	1	0	0	1	1	2	0	0	3	5
% Articulated Trucks	0%	0%	0%	0%	0%	0%	0%	0.2%	0%	0.2%	0%	0%	0%	0%	0%	0.2%	0.1%	0%	0%	0.1%	0.1%
Buses and Single-Unit Trucks	1	3	6	0	10	1	1	15	0	17	1	29	2	0	32	15	27	2	0	44	103
% Buses and Single-Unit Trucks	0.3%	3.5%	6.3%	0%	1.9%	2.0%	0.9%	3.1%	0%	2.7%	1.4%	1.4%	4.7%	0%	1.5%	3.3%	1.7%	0.4%	0%	1.8%	1.8%

*L: Left, R: Right, T: Thru, U: U-Turn

Oldham Pkwy & Ward Rd - TMC

Thu Oct 20, 2022

Full Length (7 AM-9 AM, 4 PM-6 PM)

All Classes (Lights, Articulated Trucks, Buses and Single-Unit Trucks)

All Movements

ID: 1001818, Location: 38.910111, -94.395544



Provided by: Gewalt Hamilton Associates Inc.
625 Forest Edge Drive, Vernon Hills, IL, 60061, US

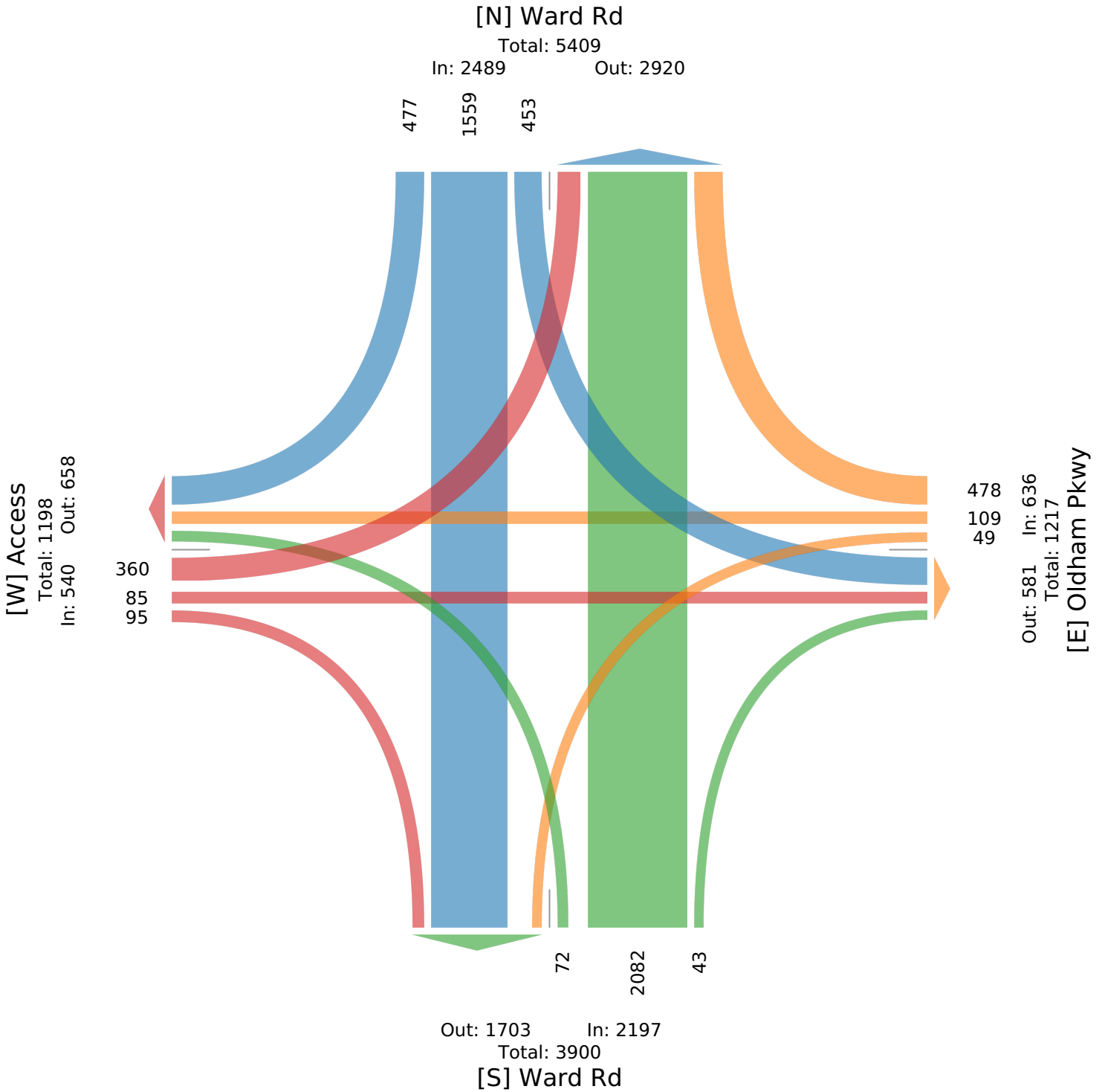

Oldham Pkwy & Ward Rd - TMC

Thu Oct 20, 2022

AM Peak (7:15 AM - 8:15 AM)

All Classes (Lights, Articulated Trucks, Buses and Single-Unit Trucks)

All Movements

ID: 1001818, Location: 38.910111, -94.395544



Provided by: Gewalt Hamilton Associates Inc.

625 Forest Edge Drive, Vernon Hills, IL, 60061, US

Leg Direction	Access Eastbound					Oldham Pkwy Westbound					Ward Rd Northbound					Ward Rd Southbound					Int
	L	T	R	U	App	L	T	R	U	App	L	T	R	U	App	L	T	R	U	App	
2022-10-20 7:15AM	11	2	2	0	15	0	5	26	0	31	4	142	1	0	147	26	58	11	0	95	288
7:30AM	8	10	2	0	20	6	8	50	0	64	5	145	3	0	153	27	70	10	0	107	344
7:45AM	6	2	2	0	10	4	7	38	0	49	2	122	3	0	127	35	56	17	0	108	294
8:00AM	10	3	6	0	19	4	8	25	0	37	3	147	6	0	156	34	54	21	0	109	321
Total	35	17	12	0	64	14	28	139	0	181	14	556	13	0	583	122	238	59	0	419	1247
% Approach	54.7%	26.6%	18.8%	0%	-	7.7%	15.5%	76.8%	0%	-	2.4%	95.4%	2.2%	0%	-	29.1%	56.8%	14.1%	0%	-	-
% Total	2.8%	1.4%	1.0%	0%	5.1%	1.1%	2.2%	11.1%	0%	14.5%	1.1%	44.6%	1.0%	0%	46.8%	9.8%	19.1%	4.7%	0%	33.6%	-
PHF	0.795	0.425	0.500	-	0.800	0.583	0.875	0.695	-	0.707	0.700	0.946	0.542	-	0.934	0.871	0.850	0.702	-	0.961	0.906
Lights	35	15	11	0	61	13	28	134	0	175	14	549	13	0	576	113	223	58	0	394	1206
% Lights	100%	88.2%	91.7%	0%	95.3%	92.9%	100%	96.4%	0%	96.7%	100%	98.7%	100%	0%	98.8%	92.6%	93.7%	98.3%	0%	94.0%	96.7%
Articulated Trucks	0	0	0	0	0	0	0	1	0	1	0	0	0	0	0	0	1	0	0	1	2
% Articulated Trucks	0%	0%	0%	0%	0%	0%	0%	0.7%	0%	0.6%	0%	0%	0%	0%	0%	0%	0.4%	0%	0%	0.2%	0.2%
Buses and Single-Unit Trucks	0	2	1	0	3	1	0	4	0	5	0	7	0	0	7	9	14	1	0	24	39
% Buses and Single-Unit Trucks	0%	11.8%	8.3%	0%	4.7%	7.1%	0%	2.9%	0%	2.8%	0%	1.3%	0%	0%	1.2%	7.4%	5.9%	1.7%	0%	5.7%	3.1%

* L: Left, R: Right, T: Thru, U: U-Turn

Oldham Pkwy & Ward Rd - TMC

Thu Oct 20, 2022

AM Peak (7:15 AM - 8:15 AM)

All Classes (Lights, Articulated Trucks, Buses and Single-Unit Trucks)

All Movements

ID: 1001818, Location: 38.910111, -94.395544



Provided by: Gewalt Hamilton Associates Inc.
625 Forest Edge Drive, Vernon Hills, IL, 60061, US

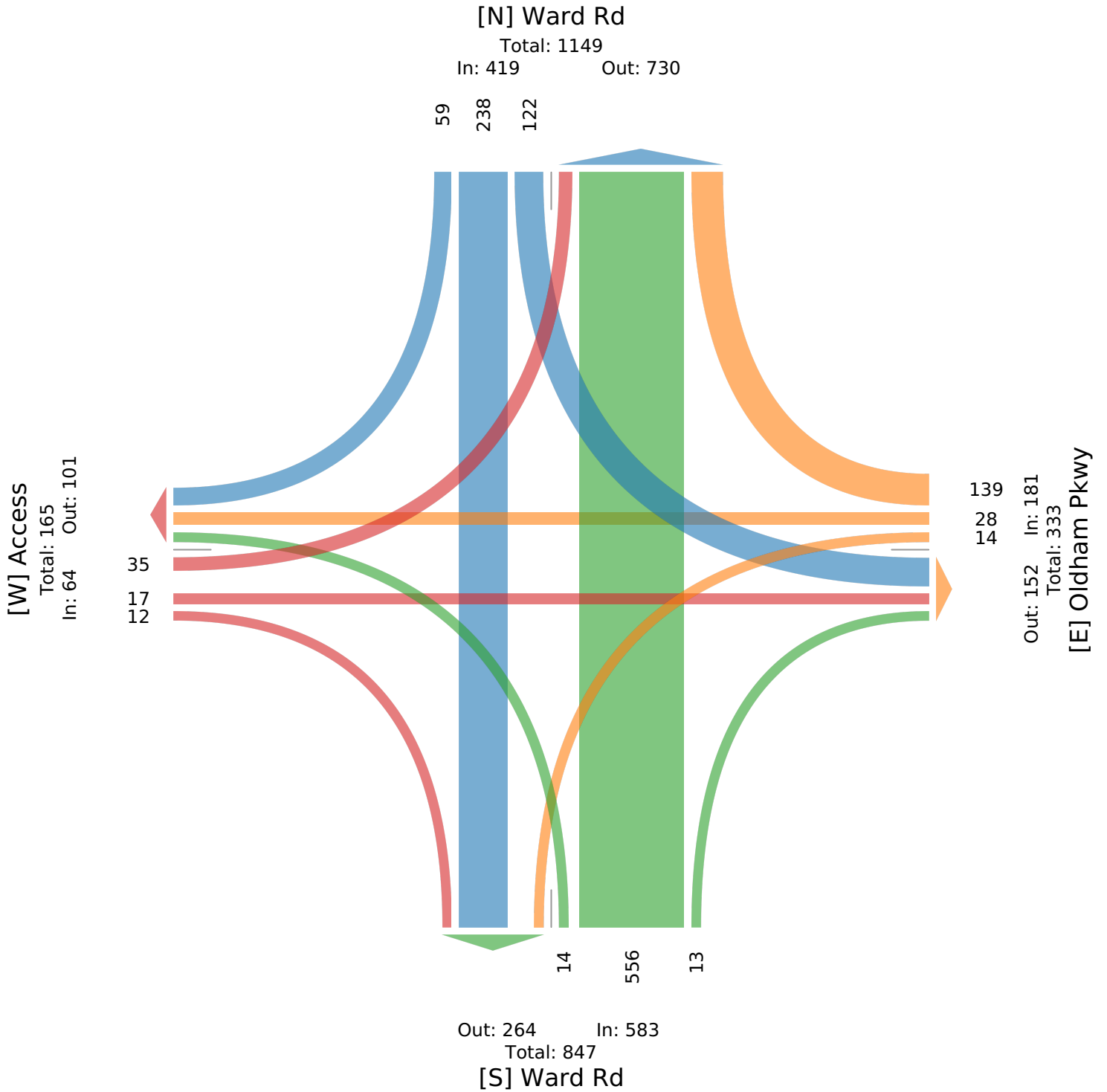

Oldham Pkwy & Ward Rd - TMC

Thu Oct 20, 2022

PM Peak (4:45 PM - 5:45 PM) - Overall Peak Hour

All Classes (Lights, Articulated Trucks, Buses and Single-Unit Trucks)

All Movements

ID: 1001818, Location: 38.910111, -94.395544



Provided by: Gewalt Hamilton Associates Inc.

625 Forest Edge Drive, Vernon Hills, IL, 60061, US

Leg Direction	Access Eastbound					Oldham Pkwy Westbound					Ward Rd Northbound					Ward Rd Southbound					Int
	L	T	R	U	App	L	T	R	U	App	L	T	R	U	App	L	T	R	U	App	
2022-10-20 4:45PM	37	11	14	0	62	2	7	35	0	44	5	136	3	0	144	25	142	40	0	207	457
5:00PM	28	4	6	0	38	3	7	30	0	40	8	122	4	0	134	32	135	53	0	220	432
5:15PM	39	8	8	0	55	8	8	35	0	51	7	134	1	0	142	32	140	52	0	224	472
5:30PM	40	6	4	0	50	2	7	20	0	29	5	145	2	0	152	44	132	51	0	227	458
Total	144	29	32	0	205	15	29	120	0	164	25	537	10	0	572	133	549	196	0	878	1819
% Approach	70.2%	14.1%	15.6%	0%	-	9.1%	17.7%	73.2%	0%	-	4.4%	93.9%	1.7%	0%	-	15.1%	62.5%	22.3%	0%	-	-
% Total	7.9%	1.6%	1.8%	0%	11.3%	0.8%	1.6%	6.6%	0%	9.0%	1.4%	29.5%	0.5%	0%	31.4%	7.3%	30.2%	10.8%	0%	48.3%	-
PHF	0.900	0.659	0.571	-	0.827	0.469	0.906	0.857	-	0.804	0.781	0.926	0.625	-	0.941	0.756	0.967	0.925	-	0.967	0.963
Lights	144	29	32	0	205	15	29	118	0	162	25	532	10	0	567	133	547	196	0	876	1810
% Lights	100%	100%	100%	0%	100%	100%	100%	98.3%	0%	98.8%	100%	99.1%	100%	0%	99.1%	100%	99.6%	100%	0%	99.8%	99.5%
Articulated Trucks	0	0	0	0	0	0	0	0	0	0	0	0	0	0	0	0	0	0	0	0	0
% Articulated Trucks	0%	0%	0%	0%	0%	0%	0%	0%	0%	0%	0%	0%	0%	0%	0%	0%	0%	0%	0%	0%	0%
Buses and Single-Unit Trucks	0	0	0	0	0	0	0	2	0	2	0	5	0	0	5	0	2	0	0	2	9
% Buses and Single-Unit Trucks	0%	0%	0%	0%	0%	0%	0%	1.7%	0%	1.2%	0%	0.9%	0%	0%	0.9%	0%	0.4%	0%	0%	0.2%	0.5%

* L: Left, R: Right, T: Thru, U: U-Turn

Oldham Pkwy & Ward Rd - TMC

Thu Oct 20, 2022

PM Peak (4:45 PM - 5:45 PM) - Overall Peak Hour

All Classes (Lights, Articulated Trucks, Buses and Single-Unit Trucks)

All Movements

ID: 1001818, Location: 38.910111, -94.395544



Provided by: Gewalt Hamilton Associates Inc.
625 Forest Edge Drive, Vernon Hills, IL, 60061, US

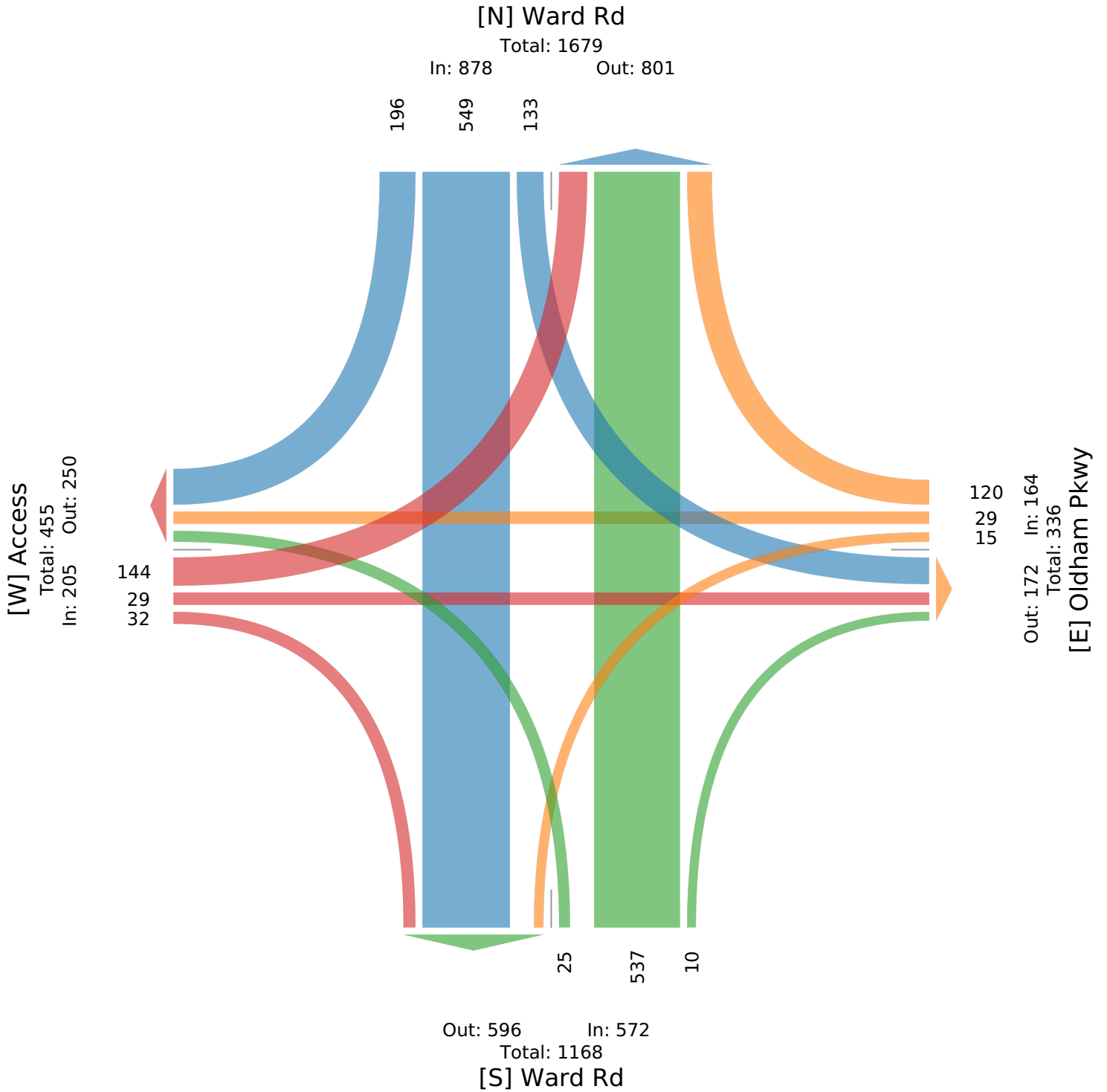

Oldham Pkwy & Ward Rd - TMC

Sat Oct 22, 2022

Full Length (12 PM-2 PM)

All Classes (Lights, Articulated Trucks, Buses and Single-Unit Trucks)

All Movements

ID: 1001811, Location: 38.910111, -94.395544



Provided by: Gewalt Hamilton Associates Inc.
625 Forest Edge Drive, Vernon Hills, IL, 60061, US

Leg Direction	Access Eastbound					Oldham Pkwy Westbound					Ward Rd Northbound					Ward Rd Southbound					Int
	L	T	R	U	App	L	T	R	U	App	L	T	R	U	App	L	T	R	U	App	
2022-10-22 12:00PM	36	2	5	0	43	5	3	38	0	46	4	125	6	0	135	36	85	45	0	166	390
12:15PM	40	3	9	0	52	3	5	24	0	32	10	150	0	0	160	27	87	48	0	162	406
12:30PM	42	7	4	0	53	1	6	16	0	23	10	131	1	0	142	21	110	50	0	181	399
12:45PM	36	4	9	0	49	2	3	35	0	40	6	138	1	0	145	25	91	42	0	158	392
Hourly Total	154	16	27	0	197	11	17	113	0	141	30	544	8	0	582	109	373	185	0	667	1587
1:00PM	41	9	5	0	55	4	7	25	0	36	7	127	2	0	136	22	93	51	1	167	394
1:15PM	36	2	11	0	49	2	4	19	0	25	5	121	1	0	127	15	102	37	0	154	355
1:30PM	23	8	7	0	38	2	4	23	0	29	5	102	2	0	109	29	95	42	0	166	342
1:45PM	26	7	6	0	39	1	4	16	0	21	6	130	2	0	138	18	108	45	0	171	369
Hourly Total	126	26	29	0	181	9	19	83	0	111	23	480	7	0	510	84	398	175	1	658	1460
Total	280	42	56	0	378	20	36	196	0	252	53	1024	15	0	1092	193	771	360	1	1325	3047
% Approach	74.1%	11.1%	14.8%	0%	-	7.9%	14.3%	77.8%	0%	-	4.9%	93.8%	1.4%	0%	-	14.6%	58.2%	27.2%	0.1%	-	-
% Total	9.2%	1.4%	1.8%	0%	12.4%	0.7%	1.2%	6.4%	0%	8.3%	1.7%	33.6%	0.5%	0%	35.8%	6.3%	25.3%	11.8%	0%	43.5%	-
Lights	280	42	55	0	377	20	35	194	0	249	53	1015	15	0	1083	193	769	360	1	1323	3032
% Lights	100%	100%	98.2%	0%	99.7%	100%	97.2%	99.0%	0%	98.8%	100%	99.1%	100%	0%	99.2%	100%	99.7%	100%	100%	99.8%	99.5%
Articulated Trucks	0	0	0	0	0	0	0	0	0	0	0	2	0	0	2	0	0	0	0	0	2
% Articulated Trucks	0%	0%	0%	0%	0%	0%	0%	0%	0%	0%	0%	0.2%	0%	0%	0.2%	0%	0%	0%	0%	0%	0.1%
Buses and Single-Unit Trucks	0	0	1	0	1	0	1	2	0	3	0	7	0	0	7	0	2	0	0	2	13
% Buses and Single-Unit Trucks	0%	0%	1.8%	0%	0.3%	0%	2.8%	1.0%	0%	1.2%	0%	0.7%	0%	0%	0.6%	0%	0.3%	0%	0%	0.2%	0.4%

*L: Left, R: Right, T: Thru, U: U-Turn

Oldham Pkwy & Ward Rd - TMC

Sat Oct 22, 2022

Full Length (12 PM-2 PM)

All Classes (Lights, Articulated Trucks, Buses and Single-Unit Trucks)

All Movements

ID: 1001811, Location: 38.910111, -94.395544



Provided by: Gewalt Hamilton Associates Inc.
625 Forest Edge Drive, Vernon Hills, IL, 60061, US

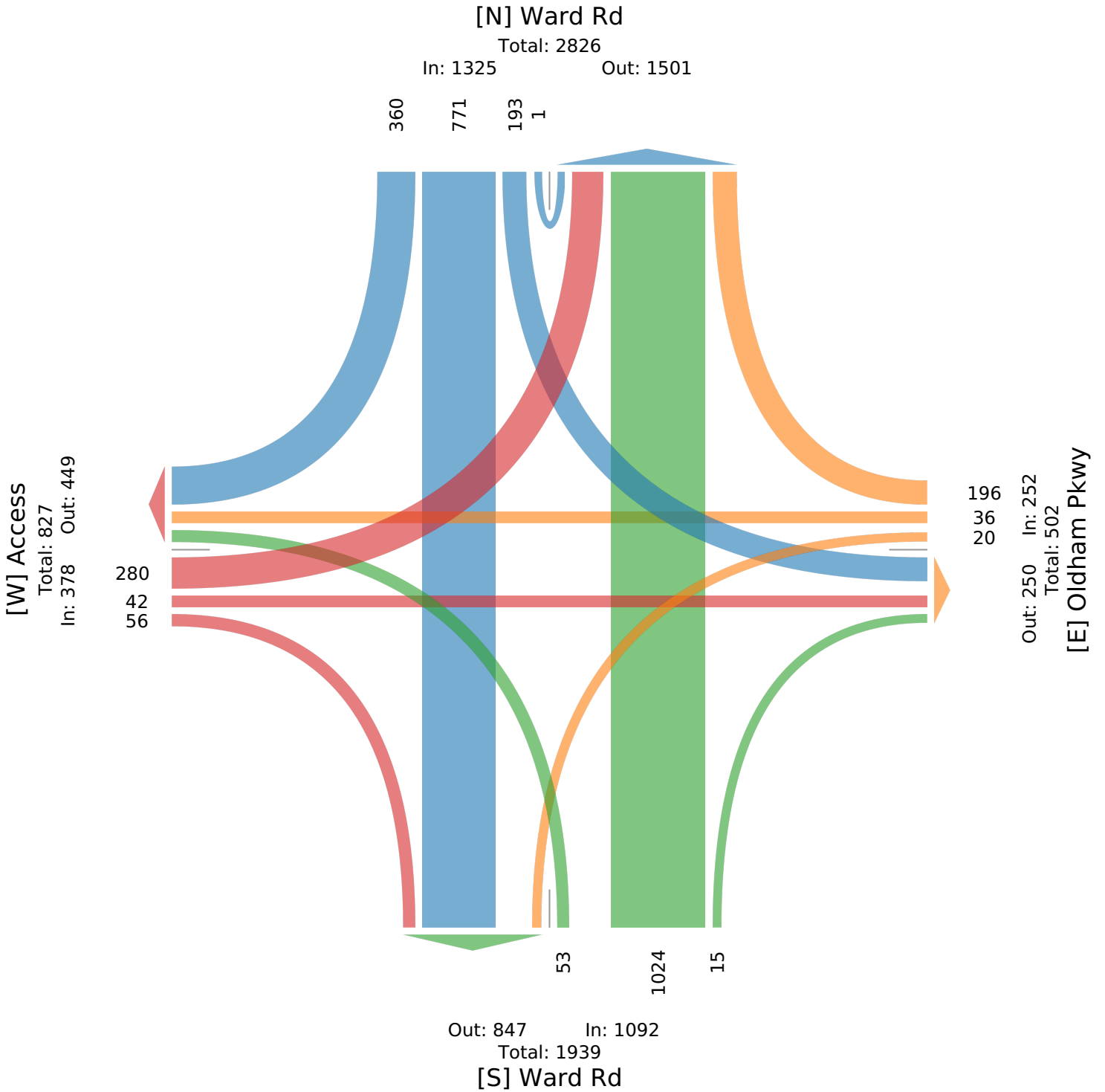

Oldham Pkwy & Ward Rd - TMC

Sat Oct 22, 2022

Midday Peak (WKND) (12:15 PM - 1:15 PM) - Overall Peak Hour
 All Classes (Lights, Articulated Trucks, Buses and Single-Unit Trucks)
 All Movements
 ID: 1001811, Location: 38.910111, -94.395544



Provided by: Gewalt Hamilton Associates Inc.
 625 Forest Edge Drive, Vernon Hills, IL, 60061, US

Leg Direction	Access Eastbound					Oldham Pkwy Westbound					Ward Rd Northbound					Ward Rd Southbound					Int
	L	T	R	U	App	L	T	R	U	App	L	T	R	U	App	L	T	R	U	App	
2022-10-22 12:15PM	40	3	9	0	52	3	5	24	0	32	10	150	0	0	160	27	87	48	0	162	406
12:30PM	42	7	4	0	53	1	6	16	0	23	10	131	1	0	142	21	110	50	0	181	399
12:45PM	36	4	9	0	49	2	3	35	0	40	6	138	1	0	145	25	91	42	0	158	392
1:00PM	41	9	5	0	55	4	7	25	0	36	7	127	2	0	136	22	93	51	1	167	394
Total	159	23	27	0	209	10	21	100	0	131	33	546	4	0	583	95	381	191	1	668	1591
% Approach	76.1%	11.0%	12.9%	0%	-	7.6%	16.0%	76.3%	0%	-	5.7%	93.7%	0.7%	0%	-	14.2%	57.0%	28.6%	0.1%	-	-
% Total	10.0%	1.4%	1.7%	0%	13.1%	0.6%	1.3%	6.3%	0%	8.2%	2.1%	34.3%	0.3%	0%	36.6%	6.0%	23.9%	12.0%	0.1%	42.0%	-
PHF	0.946	0.639	0.750	-	0.950	0.625	0.750	0.714	-	0.819	0.825	0.910	0.500	-	0.911	0.880	0.866	0.936	0.250	0.923	0.980
Lights	159	23	27	0	209	10	20	100	0	130	33	542	4	0	579	95	380	191	1	667	1585
% Lights	100%	100%	100%	0%	100%	100%	95.2%	100%	0%	99.2%	100%	99.3%	100%	0%	99.3%	100%	99.7%	100%	100%	99.9%	99.6%
Articulated Trucks	0	0	0	0	0	0	0	0	0	0	0	2	0	0	2	0	0	0	0	0	2
% Articulated Trucks	0%	0%	0%	0%	0%	0%	0%	0%	0%	0%	0%	0.4%	0%	0%	0.3%	0%	0%	0%	0%	0%	0.1%
Buses and Single-Unit Trucks	0	0	0	0	0	0	1	0	0	1	0	2	0	0	2	0	1	0	0	1	4
% Buses and Single-Unit Trucks	0%	0%	0%	0%	0%	0%	4.8%	0%	0%	0.8%	0%	0.4%	0%	0%	0.3%	0%	0.3%	0%	0%	0.1%	0.3%

* L: Left, R: Right, T: Thru, U: U-Turn

Oldham Pkwy & Ward Rd - TMC

Sat Oct 22, 2022

Midday Peak (WKND) (12:15 PM - 1:15 PM) - Overall Peak Hour

All Classes (Lights, Articulated Trucks, Buses and Single-Unit Trucks)

All Movements

ID: 1001811, Location: 38.910111, -94.395544



Provided by: Gewalt Hamilton Associates Inc.
625 Forest Edge Drive, Vernon Hills, IL, 60061, US

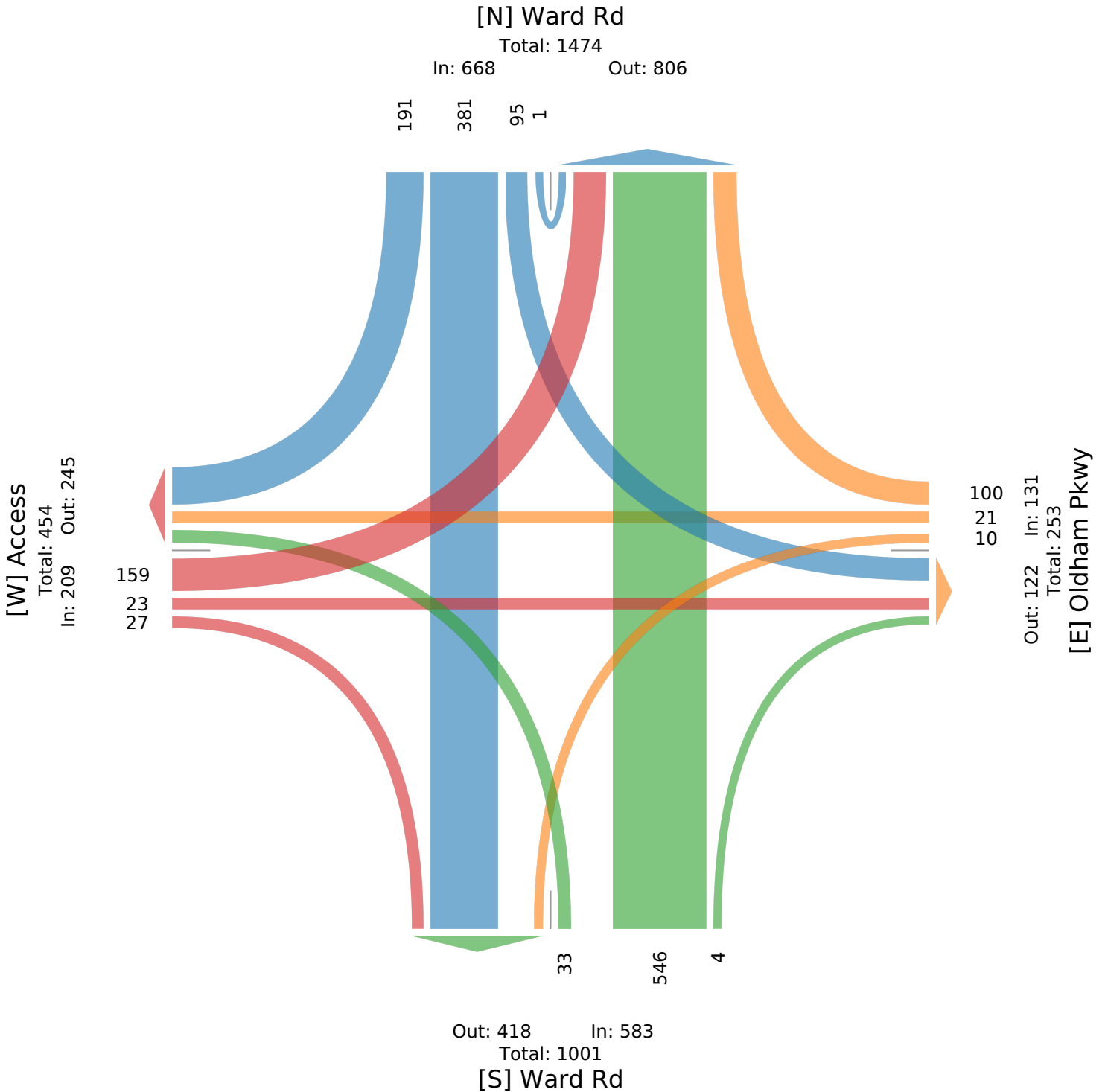

Oldham Pkwy & Ward Rd - TMC

Sat Oct 22, 2022

PM Peak (WKND) (1 PM - 2 PM)

All Classes (Lights, Articulated Trucks, Buses and Single-Unit Trucks)

All Movements

ID: 1001811, Location: 38.910111, -94.395544



Provided by: Gewalt Hamilton Associates Inc.

625 Forest Edge Drive, Vernon Hills, IL, 60061, US

Leg Direction	Access Eastbound					Oldham Pkwy Westbound					Ward Rd Northbound					Ward Rd Southbound					Int
	L	T	R	U	App	L	T	R	U	App	L	T	R	U	App	L	T	R	U	App	
2022-10-22 1:00PM	41	9	5	0	55	4	7	25	0	36	7	127	2	0	136	22	93	51	1	167	394
1:15PM	36	2	11	0	49	2	4	19	0	25	5	121	1	0	127	15	102	37	0	154	355
1:30PM	23	8	7	0	38	2	4	23	0	29	5	102	2	0	109	29	95	42	0	166	342
1:45PM	26	7	6	0	39	1	4	16	0	21	6	130	2	0	138	18	108	45	0	171	369
Total	126	26	29	0	181	9	19	83	0	111	23	480	7	0	510	84	398	175	1	658	1460
% Approach	69.6%	14.4%	16.0%	0%	-	8.1%	17.1%	74.8%	0%	-	4.5%	94.1%	1.4%	0%	-	12.8%	60.5%	26.6%	0.2%	-	-
% Total	8.6%	1.8%	2.0%	0%	12.4%	0.6%	1.3%	5.7%	0%	7.6%	1.6%	32.9%	0.5%	0%	34.9%	5.8%	27.3%	12.0%	0.1%	45.1%	-
PHF	0.768	0.722	0.659	-	0.823	0.563	0.679	0.830	-	0.771	0.821	0.923	0.875	-	0.924	0.724	0.921	0.858	0.250	0.962	0.926
Lights	126	26	28	0	180	9	19	81	0	109	23	476	7	0	506	84	397	175	1	657	1452
% Lights	100%	100%	96.6%	0%	99.4%	100%	100%	97.6%	0%	98.2%	100%	99.2%	100%	0%	99.2%	100%	99.7%	100%	100%	99.8%	99.5%
Articulated Trucks	0	0	0	0	0	0	0	0	0	0	0	0	0	0	0	0	0	0	0	0	0
% Articulated Trucks	0%	0%	0%	0%	0%	0%	0%	0%	0%	0%	0%	0%	0%	0%	0%	0%	0%	0%	0%	0%	0%
Buses and Single-Unit Trucks	0	0	1	0	1	0	0	2	0	2	0	4	0	0	4	0	1	0	0	1	8
% Buses and Single-Unit Trucks	0%	0%	3.4%	0%	0.6%	0%	0%	2.4%	0%	1.8%	0%	0.8%	0%	0%	0.8%	0%	0.3%	0%	0%	0.2%	0.5%

* L: Left, R: Right, T: Thru, U: U-Turn

Oldham Pkwy & Ward Rd - TMC

Sat Oct 22, 2022

PM Peak (WKND) (1 PM - 2 PM)

All Classes (Lights, Articulated Trucks, Buses and Single-Unit Trucks)

All Movements

ID: 1001811, Location: 38.910111, -94.395544



Provided by: Gewalt Hamilton Associates Inc.
625 Forest Edge Drive, Vernon Hills, IL, 60061, US

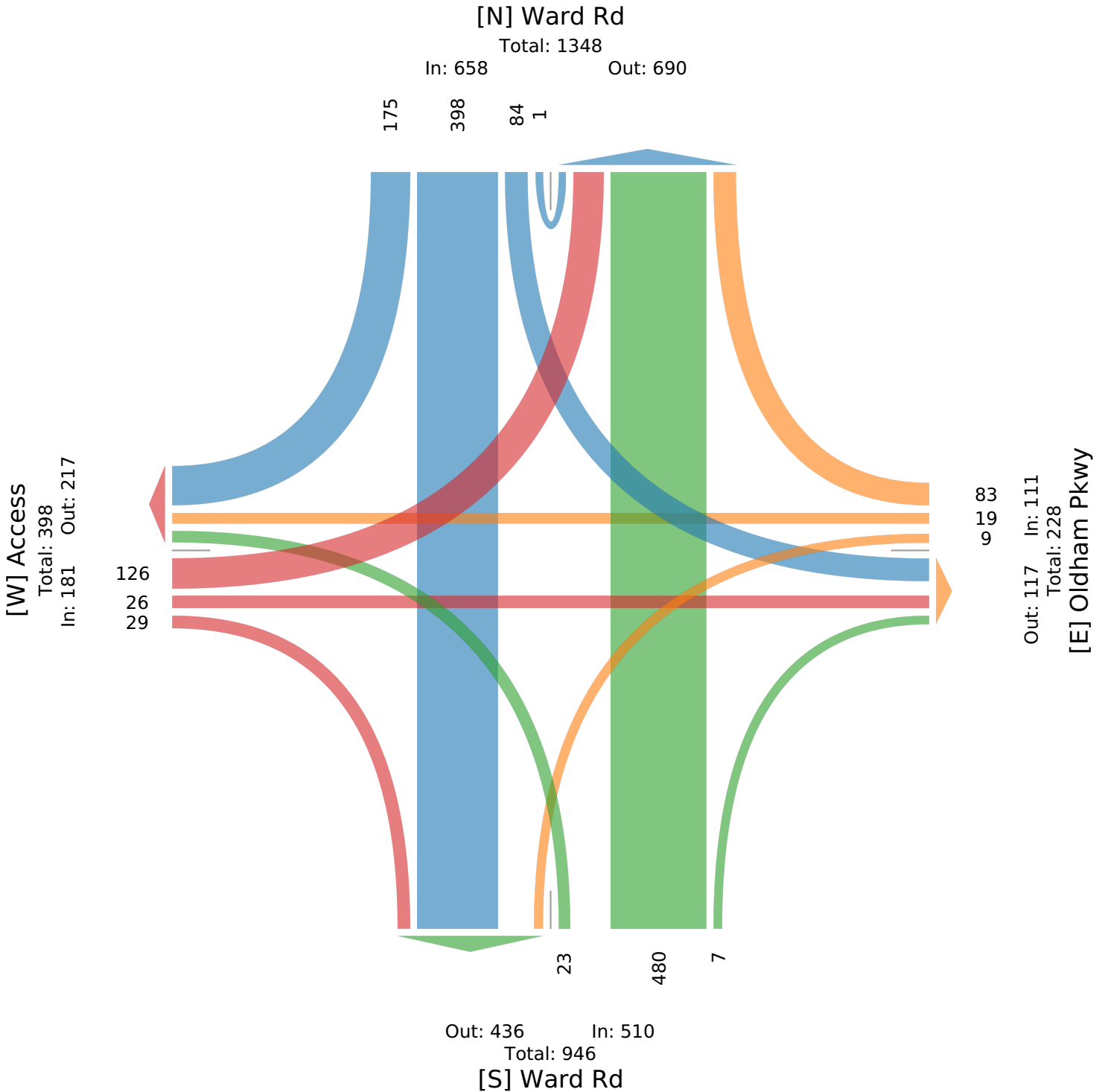

Oldham Pkwy & Jefferson St - TMC

Thu Oct 20, 2022

Full Length (7 AM-9 AM, 4 PM-6 PM)

All Classes (Lights, Articulated Trucks, Buses and Single-Unit Trucks)

All Movements

ID: 1001815, Location: 38.900058, -94.377166



Provided by: Gewalt Hamilton Associates Inc.

625 Forest Edge Drive, Vernon Hills, IL, 60061, US

Leg Direction	Oldham Pkwy Westbound				Jefferson St Northbound				Oldham Pkwy Southbound				
Time	L	R	U	App	T	R	U	App	L	T	U	App	Int
2022-10-20 7:00AM	12	8	0	20	3	2	0	5	8	5	0	13	38
7:15AM	52	15	0	67	13	15	0	28	7	9	0	16	111
7:30AM	50	29	0	79	15	14	0	29	9	11	0	20	128
7:45AM	27	40	0	67	4	3	0	7	10	9	0	19	93
Hourly Total	141	92	0	233	35	34	0	69	34	34	0	68	370
8:00AM	52	23	0	75	5	15	0	20	12	9	0	21	116
8:15AM	10	24	1	35	12	16	0	28	16	2	0	18	81
8:30AM	9	22	0	31	0	3	0	3	14	4	0	18	52
8:45AM	9	19	0	28	5	2	0	7	18	5	0	23	58
Hourly Total	80	88	1	169	22	36	0	58	60	20	0	80	307
4:00PM	18	8	0	26	6	9	0	15	19	5	0	24	65
4:15PM	24	15	0	39	6	10	0	16	13	6	0	19	74
4:30PM	14	17	0	31	12	12	0	24	29	6	0	35	90
4:45PM	11	16	0	27	6	10	0	16	24	4	0	28	71
Hourly Total	67	56	0	123	30	41	0	71	85	21	0	106	300
5:00PM	15	21	0	36	7	5	0	12	23	4	0	27	75
5:15PM	17	18	0	35	9	9	0	18	21	6	0	27	80
5:30PM	10	12	0	22	4	9	0	13	14	3	0	17	52
5:45PM	18	15	0	33	4	0	0	4	12	8	0	20	57
Hourly Total	60	66	0	126	24	23	0	47	70	21	0	91	264
Total	348	302	1	651	111	134	0	245	249	96	0	345	1241
% Approach	53.5%	46.4%	0.2%	-	45.3%	54.7%	0%	-	72.2%	27.8%	0%	-	-
% Total	28.0%	24.3%	0.1%	52.5%	8.9%	10.8%	0%	19.7%	20.1%	7.7%	0%	27.8%	-
Lights	344	292	1	637	106	134	0	240	238	92	0	330	1207
% Lights	98.9%	96.7%	100%	97.8%	95.5%	100%	0%	98.0%	95.6%	95.8%	0%	95.7%	97.3%
Articulated Trucks	0	5	0	5	0	0	0	0	3	0	0	3	8
% Articulated Trucks	0%	1.7%	0%	0.8%	0%	0%	0%	0%	1.2%	0%	0%	0.9%	0.6%
Buses and Single-Unit Trucks	4	5	0	9	5	0	0	5	8	4	0	12	26
% Buses and Single-Unit Trucks	1.1%	1.7%	0%	1.4%	4.5%	0%	0%	2.0%	3.2%	4.2%	0%	3.5%	2.1%

*L: Left, R: Right, T: Thru, U: U-Turn

Oldham Pkwy & Jefferson St - TMC

Thu Oct 20, 2022

Full Length (7 AM-9 AM, 4 PM-6 PM)

All Classes (Lights, Articulated Trucks, Buses and Single-Unit Trucks)

All Movements

ID: 1001815, Location: 38.900058, -94.377166



Provided by: Gewalt Hamilton Associates Inc.
625 Forest Edge Drive, Vernon Hills, IL, 60061, US

[N] Oldham Pkwy

Total: 758

In: 345 Out: 413

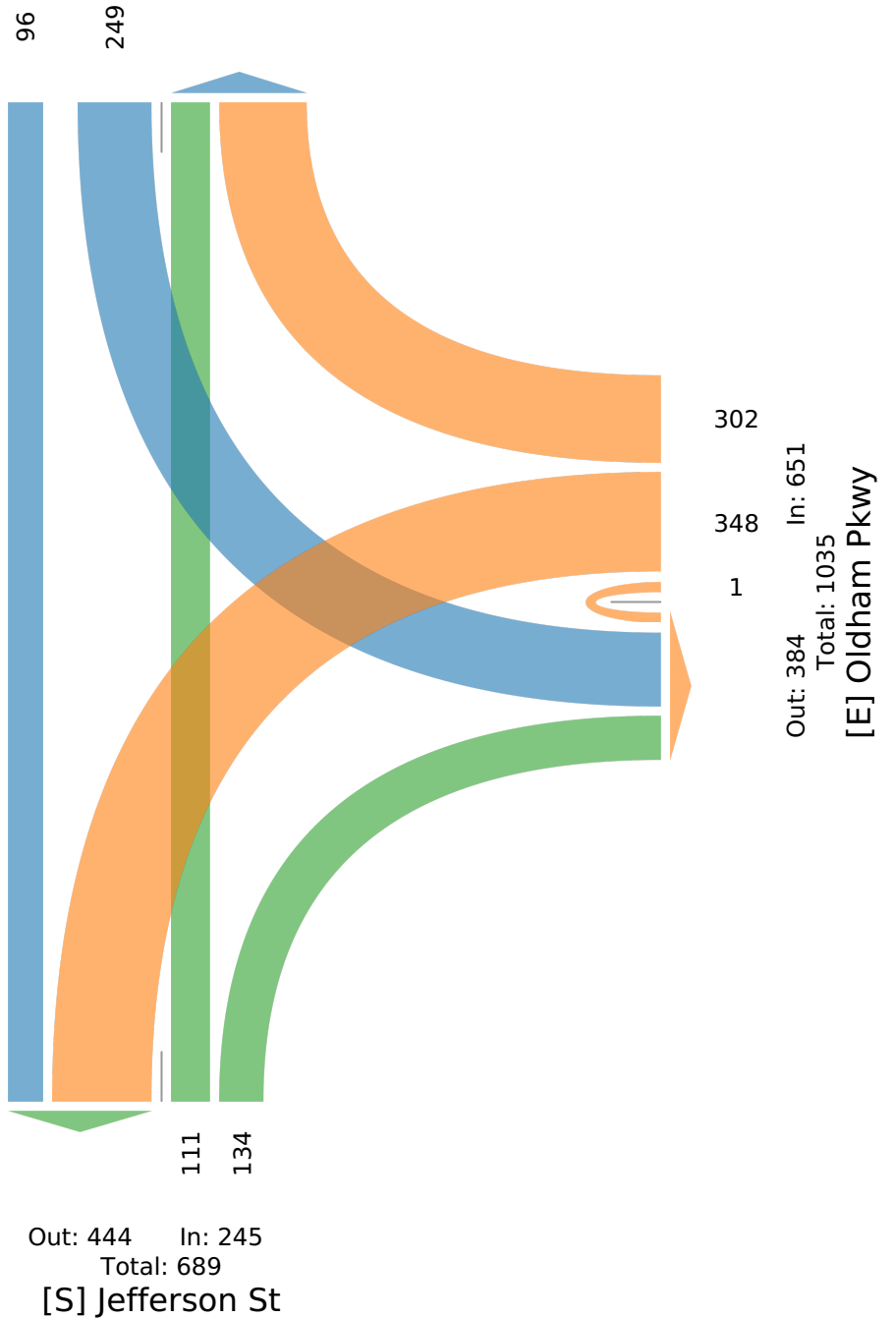

Oldham Pkwy & Jefferson St - TMC

Thu Oct 20, 2022

AM Peak (7:15 AM - 8:15 AM) - Overall Peak Hour

All Classes (Lights, Articulated Trucks, Buses and Single-Unit Trucks)

All Movements

ID: 1001815, Location: 38.900058, -94.377166



Provided by: Gewalt Hamilton Associates Inc.

625 Forest Edge Drive, Vernon Hills, IL, 60061, US

Leg Direction	Oldham Pkwy Westbound				Jefferson St Northbound				Oldham Pkwy Southbound				
Time	L	R	U	App	T	R	U	App	L	T	U	App	Int
2022-10-20 7:15AM	52	15	0	67	13	15	0	28	7	9	0	16	111
7:30AM	50	29	0	79	15	14	0	29	9	11	0	20	128
7:45AM	27	40	0	67	4	3	0	7	10	9	0	19	93
8:00AM	52	23	0	75	5	15	0	20	12	9	0	21	116
Total	181	107	0	288	37	47	0	84	38	38	0	76	448
% Approach	62.8%	37.2%	0%	-	44.0%	56.0%	0%	-	50.0%	50.0%	0%	-	-
% Total	40.4%	23.9%	0%	64.3%	8.3%	10.5%	0%	18.8%	8.5%	8.5%	0%	17.0%	-
PHF	0.870	0.669	-	0.911	0.617	0.783	-	0.724	0.792	0.864	-	0.905	0.875
Lights	181	100	0	281	34	47	0	81	36	36	0	72	434
% Lights	100%	93.5%	0%	97.6%	91.9%	100%	0%	96.4%	94.7%	94.7%	0%	94.7%	96.9%
Articulated Trucks	0	4	0	4	0	0	0	0	0	0	0	0	4
% Articulated Trucks	0%	3.7%	0%	1.4%	0%	0%	0%	0%	0%	0%	0%	0%	0.9%
Buses and Single-Unit Trucks	0	3	0	3	3	0	0	3	2	2	0	4	10
% Buses and Single-Unit Trucks	0%	2.8%	0%	1.0%	8.1%	0%	0%	3.6%	5.3%	5.3%	0%	5.3%	2.2%

* L: Left, R: Right, T: Thru, U: U-Turn

Oldham Pkwy & Jefferson St - TMC

Thu Oct 20, 2022

AM Peak (7:15 AM - 8:15 AM) - Overall Peak Hour

All Classes (Lights, Articulated Trucks, Buses and Single-Unit Trucks)

All Movements

ID: 1001815, Location: 38.900058, -94.377166



Provided by: Gewalt Hamilton Associates Inc.
625 Forest Edge Drive, Vernon Hills, IL, 60061, US

[N] Oldham Pkwy

Total: 220

In: 76 Out: 144

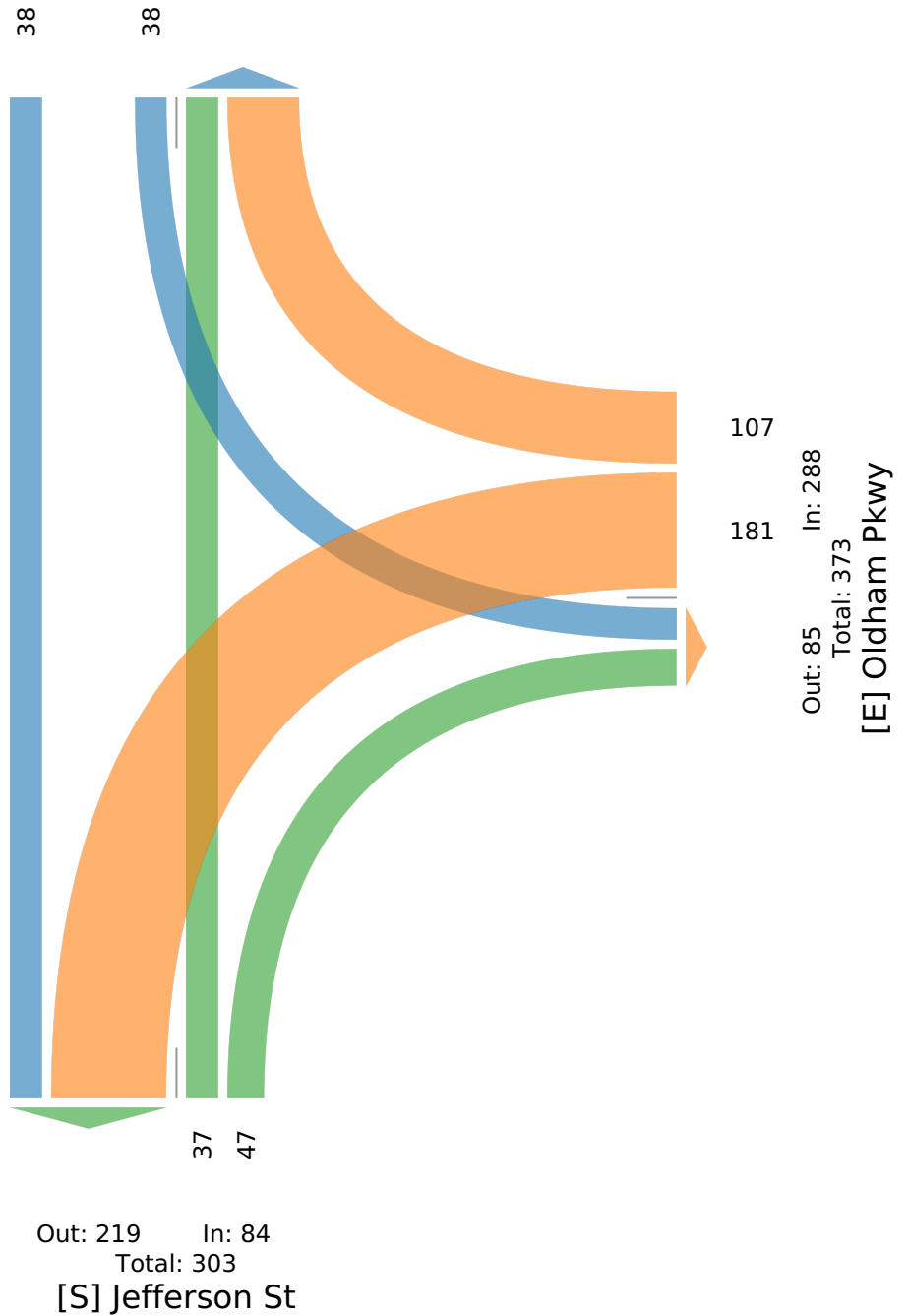

Oldham Pkwy & Jefferson St - TMC

Thu Oct 20, 2022

PM Peak (4:30 PM - 5:30 PM)

All Classes (Lights, Articulated Trucks, Buses and Single-Unit Trucks)

All Movements

ID: 1001815, Location: 38.900058, -94.377166



Provided by: Gewalt Hamilton Associates Inc.

625 Forest Edge Drive, Vernon Hills, IL, 60061, US

Leg Direction	Oldham Pkwy Westbound				Jefferson St Northbound				Oldham Pkwy Southbound				
Time	L	R	U	App	T	R	U	App	L	T	U	App	Int
2022-10-20 4:30PM	14	17	0	31	12	12	0	24	29	6	0	35	90
4:45PM	11	16	0	27	6	10	0	16	24	4	0	28	71
5:00PM	15	21	0	36	7	5	0	12	23	4	0	27	75
5:15PM	17	18	0	35	9	9	0	18	21	6	0	27	80
Total	57	72	0	129	34	36	0	70	97	20	0	117	316
% Approach	44.2%	55.8%	0%	-	48.6%	51.4%	0%	-	82.9%	17.1%	0%	-	-
% Total	18.0%	22.8%	0%	40.8%	10.8%	11.4%	0%	22.2%	30.7%	6.3%	0%	37.0%	-
PHF	0.838	0.857	-	0.896	0.708	0.750	-	0.729	0.836	0.833	-	0.836	0.878
Lights	57	71	0	128	34	36	0	70	94	20	0	114	312
% Lights	100%	98.6%	0%	99.2%	100%	100%	0%	100%	96.9%	100%	0%	97.4%	98.7%
Articulated Trucks	0	0	0	0	0	0	0	0	0	0	0	0	0
% Articulated Trucks	0%	0%	0%	0%	0%	0%	0%	0%	0%	0%	0%	0%	0%
Buses and Single-Unit Trucks	0	1	0	1	0	0	0	0	3	0	0	3	4
% Buses and Single-Unit Trucks	0%	1.4%	0%	0.8%	0%	0%	0%	0%	3.1%	0%	0%	2.6%	1.3%

* L: Left, R: Right, T: Thru, U: U-Turn

Oldham Pkwy & Jefferson St - TMC

Thu Oct 20, 2022

PM Peak (4:30 PM - 5:30 PM)

All Classes (Lights, Articulated Trucks, Buses and Single-Unit Trucks)

All Movements

ID: 1001815, Location: 38.900058, -94.377166



Provided by: Gewalt Hamilton Associates Inc.
625 Forest Edge Drive, Vernon Hills, IL, 60061, US

[N] Oldham Pkwy

Total: 223

In: 117

Out: 106

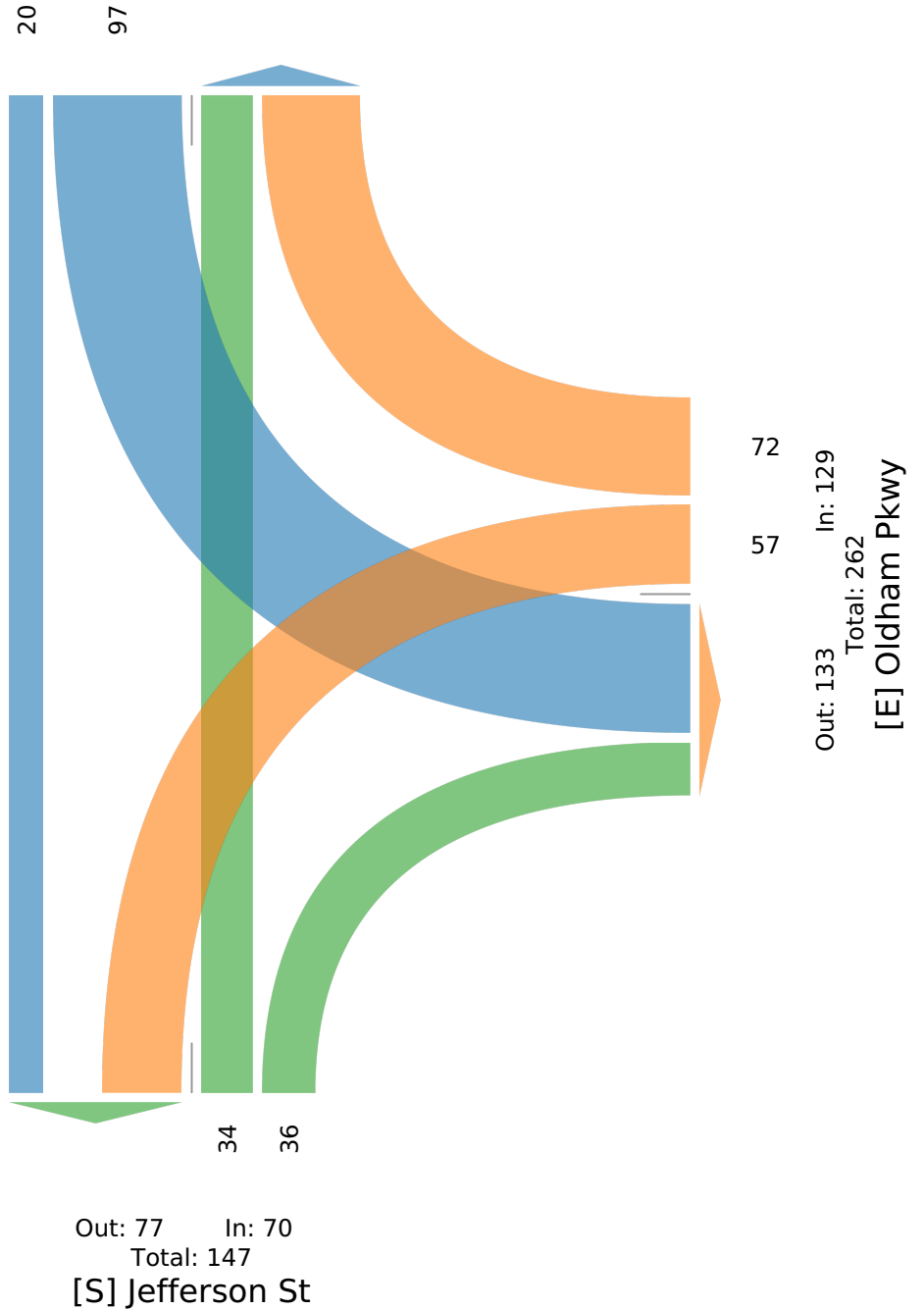

Oldham Pkwy & Jefferson St - TMC

Sat Oct 22, 2022

Full Length (12 PM-2 PM)

All Classes (Lights, Articulated Trucks, Buses and Single-Unit Trucks)

All Movements

ID: 1001810, Location: 38.900058, -94.377166



Provided by: Gewalt Hamilton Associates Inc.
625 Forest Edge Drive, Vernon Hills, IL, 60061, US

Leg Direction	Oldham Pkwy Westbound				Jefferson St Northbound				Oldham Pkwy Southbound				
Time	L	R	U	App	T	R	U	App	L	T	U	App	Int
2022-10-22 12:00PM	6	14	3	23	5	3	0	8	12	3	0	15	46
12:15PM	3	12	1	16	2	1	0	3	10	2	0	12	31
12:30PM	3	10	0	13	4	1	0	5	13	4	0	17	35
12:45PM	5	10	0	15	4	3	0	7	13	3	0	16	38
Hourly Total	17	46	4	67	15	8	0	23	48	12	0	60	150
1:00PM	5	16	0	21	3	3	0	6	12	5	0	17	44
1:15PM	4	13	0	17	2	0	0	2	17	1	0	18	37
1:30PM	4	20	5	29	3	0	0	3	11	8	0	19	51
1:45PM	11	11	0	22	3	0	0	3	14	2	0	16	41
Hourly Total	24	60	5	89	11	3	0	14	54	16	0	70	173
Total	41	106	9	156	26	11	0	37	102	28	0	130	323
% Approach	26.3%	67.9%	5.8%	-	70.3%	29.7%	0%	-	78.5%	21.5%	0%	-	-
% Total	12.7%	32.8%	2.8%	48.3%	8.0%	3.4%	0%	11.5%	31.6%	8.7%	0%	40.2%	-
Lights	41	104	9	154	26	11	0	37	101	28	0	129	320
% Lights	100%	98.1%	100%	98.7%	100%	100%	0%	100%	99.0%	100%	0%	99.2%	99.1%
Articulated Trucks	0	1	0	1	0	0	0	0	0	0	0	0	1
% Articulated Trucks	0%	0.9%	0%	0.6%	0%	0%	0%	0%	0%	0%	0%	0%	0.3%
Buses and Single-Unit Trucks	0	1	0	1	0	0	0	0	1	0	0	1	2
% Buses and Single-Unit Trucks	0%	0.9%	0%	0.6%	0%	0%	0%	0%	1.0%	0%	0%	0.8%	0.6%

*L: Left, R: Right, T: Thru, U: U-Turn

Oldham Pkwy & Jefferson St - TMC

Sat Oct 22, 2022

Full Length (12 PM-2 PM)

All Classes (Lights, Articulated Trucks, Buses and Single-Unit Trucks)

All Movements

ID: 1001810, Location: 38.900058, -94.377166



Provided by: Gewalt Hamilton Associates Inc.
625 Forest Edge Drive, Vernon Hills, IL, 60061, US

[N] Oldham Pkwy

Total: 262

In: 130

Out: 132

28

102



106

In: 156

41

9

Out: 122

Total: 278

[E] Oldham Pkwy

26

11

Out: 69

In: 37

Total: 106

[S] Jefferson St

Oldham Pkwy & Jefferson St - TMC

Sat Oct 22, 2022

Midday Peak (WKND), PM Peak (WKND) (1 PM - 2 PM) - Overall Peak Hour

All Classes (Lights, Articulated Trucks, Buses and Single-Unit Trucks)

All Movements

ID: 1001810, Location: 38.900058, -94.377166



Provided by: Gewalt Hamilton Associates Inc.
625 Forest Edge Drive, Vernon Hills, IL, 60061, US

Leg Direction	Oldham Pkwy Westbound				Jefferson St Northbound				Oldham Pkwy Southbound				
Time	L	R	U	App	T	R	U	App	L	T	U	App	Int
2022-10-22 1:00PM	5	16	0	21	3	3	0	6	12	5	0	17	44
1:15PM	4	13	0	17	2	0	0	2	17	1	0	18	37
1:30PM	4	20	5	29	3	0	0	3	11	8	0	19	51
1:45PM	11	11	0	22	3	0	0	3	14	2	0	16	41
Total	24	60	5	89	11	3	0	14	54	16	0	70	173
% Approach	27.0%	67.4%	5.6%	-	78.6%	21.4%	0%	-	77.1%	22.9%	0%	-	-
% Total	13.9%	34.7%	2.9%	51.4%	6.4%	1.7%	0%	8.1%	31.2%	9.2%	0%	40.5%	-
PHF	0.545	0.750	0.250	0.767	0.917	0.250	-	0.583	0.794	0.500	-	0.921	0.848
Lights	24	58	5	87	11	3	0	14	54	16	0	70	171
% Lights	100%	96.7%	100%	97.8%	100%	100%	0%	100%	100%	100%	0%	100%	98.8%
Articulated Trucks	0	1	0	1	0	0	0	0	0	0	0	0	1
% Articulated Trucks	0%	1.7%	0%	1.1%	0%	0%	0%	0%	0%	0%	0%	0%	0.6%
Buses and Single-Unit Trucks	0	1	0	1	0	0	0	0	0	0	0	0	1
% Buses and Single-Unit Trucks	0%	1.7%	0%	1.1%	0%	0%	0%	0%	0%	0%	0%	0%	0.6%

*L: Left, R: Right, T: Thru, U: U-Turn

Oldham Pkwy & Jefferson St - TMC

Sat Oct 22, 2022

Midday Peak (WKND), PM Peak (WKND) (1 PM - 2 PM) - Overall Peak Hour

All Classes (Lights, Articulated Trucks, Buses and Single-Unit Trucks)

All Movements

ID: 1001810, Location: 38.900058, -94.377166



Provided by: Gewalt Hamilton Associates Inc.
625 Forest Edge Drive, Vernon Hills, IL, 60061, US

[N] Oldham Pkwy

Total: 141

In: 70 Out: 71

16

54



60

24

5

Out: 62 In: 89

Total: 151

[E] Oldham Pkwy

Out: 40 In: 14

Total: 54

[S] Jefferson St

M-291 & Oldham Pkwy - TMC

Thu Oct 20, 2022

Full Length (7 AM-9 AM, 4 PM-6 PM)

All Classes (Lights, Articulated Trucks, Buses and Single-Unit Trucks)

All Movements

ID: 1001814, Location: 38.900052, -94.375988



Provided by: Gewalt Hamilton Associates Inc.

625 Forest Edge Drive, Vernon Hills, IL, 60061, US

Leg Direction	Oldham Pkwy Eastbound				M-291 Northbound				M-291 Southbound				Int
	L	R	U	App	L	T	U	App	T	R	U	App	
2022-10-20 7:00AM	11	0	0	11	3	407	0	410	223	17	0	240	661
7:15AM	19	2	0	21	3	387	0	390	314	66	0	380	791
7:30AM	17	5	0	22	10	419	0	429	305	68	0	373	824
7:45AM	10	5	0	15	8	330	0	338	327	59	0	386	739
Hourly Total	57	12	0	69	24	1543	0	1567	1169	210	0	1379	3015
8:00AM	19	6	0	25	10	385	0	395	287	64	0	351	771
8:15AM	29	3	0	32	11	349	0	360	234	24	0	258	650
8:30AM	11	7	0	18	8	271	0	279	232	23	0	255	552
8:45AM	16	2	0	18	5	291	0	296	209	24	0	233	547
Hourly Total	75	18	0	93	34	1296	0	1330	962	135	0	1097	2520
4:00PM	21	5	0	26	5	329	0	334	395	22	0	417	777
4:15PM	18	5	0	23	5	341	0	346	432	33	0	465	834
4:30PM	26	10	0	36	6	402	0	408	473	26	0	499	943
4:45PM	23	11	0	34	7	336	0	343	465	19	0	484	861
Hourly Total	88	31	0	119	23	1408	0	1431	1765	100	0	1865	3415
5:00PM	23	3	0	26	2	421	0	423	467	32	0	499	948
5:15PM	22	9	0	31	6	377	0	383	396	29	0	425	839
5:30PM	17	8	0	25	4	372	0	376	345	18	0	363	764
5:45PM	9	3	0	12	4	285	0	289	383	31	0	414	715
Hourly Total	71	23	0	94	16	1455	0	1471	1591	110	0	1701	3266
Total	291	84	0	375	97	5702	0	5799	5487	555	0	6042	12216
% Approach	77.6%	22.4%	0%	-	1.7%	98.3%	0%	-	90.8%	9.2%	0%	-	-
% Total	2.4%	0.7%	0%	3.1%	0.8%	46.7%	0%	47.5%	44.9%	4.5%	0%	49.5%	-
Lights	279	83	0	362	91	5462	0	5553	5270	546	0	5816	11731
% Lights	95.9%	98.8%	0%	96.5%	93.8%	95.8%	0%	95.8%	96.0%	98.4%	0%	96.3%	96.0%
Articulated Trucks	4	0	0	4	1	80	0	81	78	3	0	81	166
% Articulated Trucks	1.4%	0%	0%	1.1%	1.0%	1.4%	0%	1.4%	1.4%	0.5%	0%	1.3%	1.4%
Buses and Single-Unit Trucks	8	1	0	9	5	160	0	165	139	6	0	145	319
% Buses and Single-Unit Trucks	2.7%	1.2%	0%	2.4%	5.2%	2.8%	0%	2.8%	2.5%	1.1%	0%	2.4%	2.6%

*L: Left, R: Right, T: Thru, U: U-Turn

M-291 & Oldham Pkwy - TMC

Thu Oct 20, 2022

Full Length (7 AM-9 AM, 4 PM-6 PM)

All Classes (Lights, Articulated Trucks, Buses and Single-Unit Trucks)

All Movements

ID: 1001814, Location: 38.900052, -94.375988



Provided by: Gewalt Hamilton Associates Inc.
625 Forest Edge Drive, Vernon Hills, IL, 60061, US

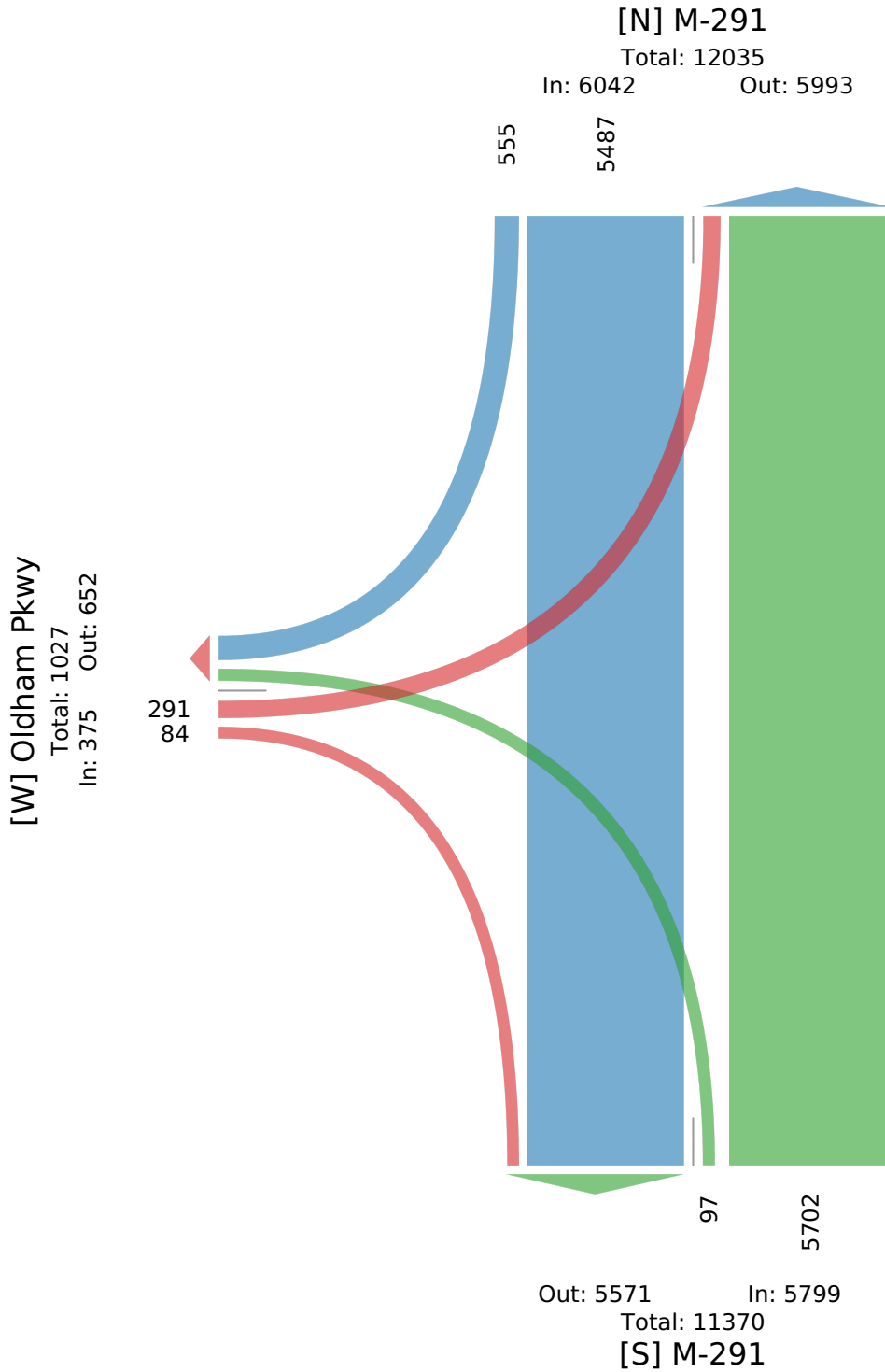

M-291 & Oldham Pkwy - TMC

Thu Oct 20, 2022

AM Peak (7:15 AM - 8:15 AM)

All Classes (Lights, Articulated Trucks, Buses and Single-Unit Trucks)

All Movements

ID: 1001814, Location: 38.900052, -94.375988



Provided by: Gewalt Hamilton Associates Inc.

625 Forest Edge Drive, Vernon Hills, IL, 60061, US

Leg Direction	Oldham Pkwy Eastbound				M-291 Northbound				M-291 Southbound				Int
	L	R	U	App	L	T	U	App	T	R	U	App	
2022-10-20 7:15AM	19	2	0	21	3	387	0	390	314	66	0	380	791
7:30AM	17	5	0	22	10	419	0	429	305	68	0	373	824
7:45AM	10	5	0	15	8	330	0	338	327	59	0	386	739
8:00AM	19	6	0	25	10	385	0	395	287	64	0	351	771
Total	65	18	0	83	31	1521	0	1552	1233	257	0	1490	3125
% Approach	78.3%	21.7%	0%	-	2.0%	98.0%	0%	-	82.8%	17.2%	0%	-	-
% Total	2.1%	0.6%	0%	2.7%	1.0%	48.7%	0%	49.7%	39.5%	8.2%	0%	47.7%	-
PHF	0.855	0.750	-	0.830	0.775	0.908	-	0.904	0.943	0.945	-	0.965	0.948
Lights	63	18	0	81	28	1436	0	1464	1157	252	0	1409	2954
% Lights	96.9%	100%	0%	97.6%	90.3%	94.4%	0%	94.3%	93.8%	98.1%	0%	94.6%	94.5%
Articulated Trucks	0	0	0	0	1	20	0	21	28	2	0	30	51
% Articulated Trucks	0%	0%	0%	0%	3.2%	1.3%	0%	1.4%	2.3%	0.8%	0%	2.0%	1.6%
Buses and Single-Unit Trucks	2	0	0	2	2	65	0	67	48	3	0	51	120
% Buses and Single-Unit Trucks	3.1%	0%	0%	2.4%	6.5%	4.3%	0%	4.3%	3.9%	1.2%	0%	3.4%	3.8%

* L: Left, R: Right, T: Thru, U: U-Turn

M-291 & Oldham Pkwy - TMC

Thu Oct 20, 2022

AM Peak (7:15 AM - 8:15 AM)

All Classes (Lights, Articulated Trucks, Buses and Single-Unit Trucks)

All Movements

ID: 1001814, Location: 38.900052, -94.375988



Provided by: Gewalt Hamilton Associates Inc.
625 Forest Edge Drive, Vernon Hills, IL, 60061, US

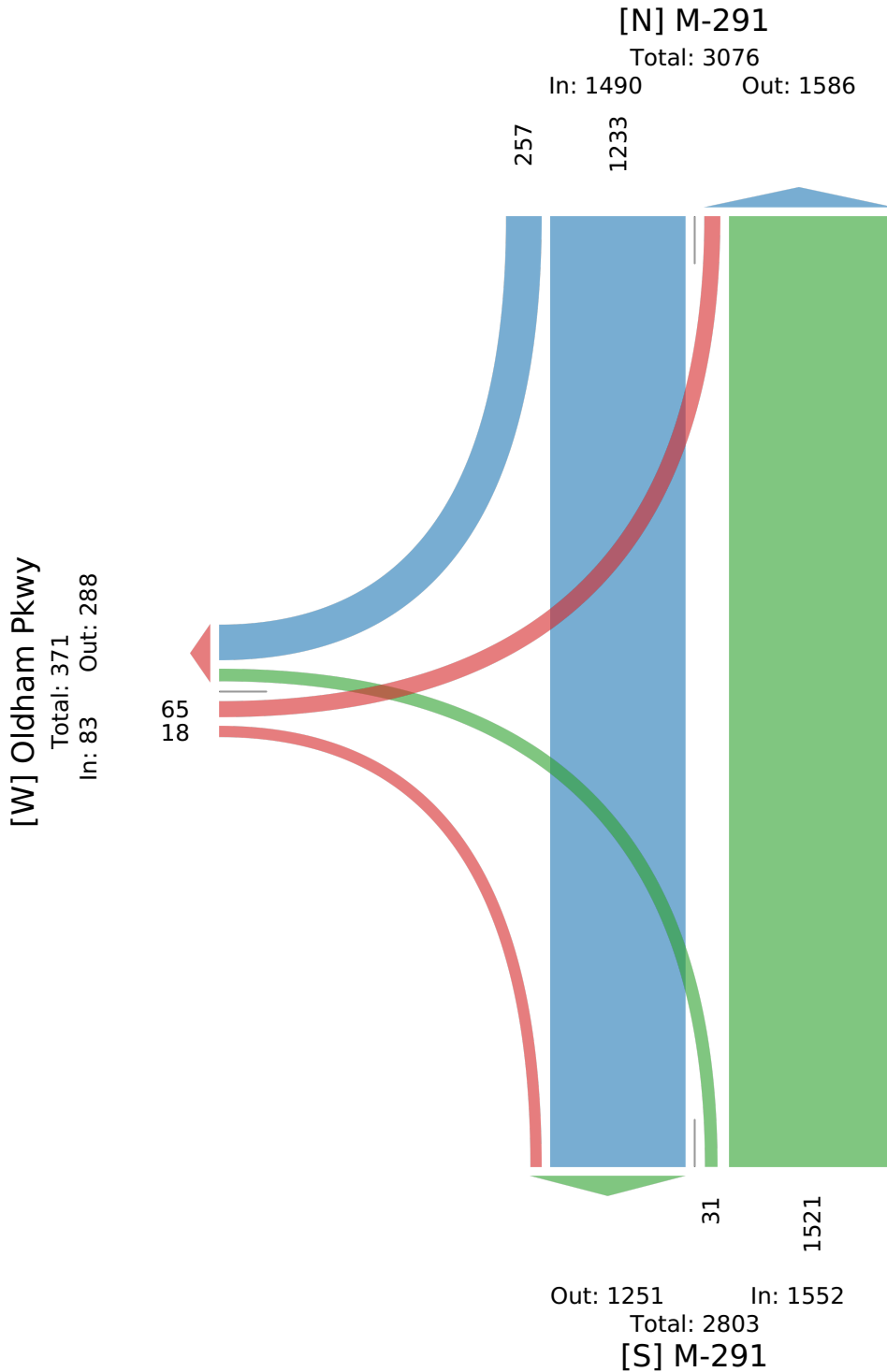

M-291 & Oldham Pkwy - TMC

Thu Oct 20, 2022

PM Peak (4:30 PM - 5:30 PM) - Overall Peak Hour

All Classes (Lights, Articulated Trucks, Buses and Single-Unit Trucks)

All Movements

ID: 1001814, Location: 38.900052, -94.375988



Provided by: Gewalt Hamilton Associates Inc.

625 Forest Edge Drive, Vernon Hills, IL, 60061, US

Leg Direction	Oldham Pkwy Eastbound				M-291 Northbound				M-291 Southbound				Int
	L	R	U	App	L	T	U	App	T	R	U	App	
2022-10-20 4:30PM	26	10	0	36	6	402	0	408	473	26	0	499	943
4:45PM	23	11	0	34	7	336	0	343	465	19	0	484	861
5:00PM	23	3	0	26	2	421	0	423	467	32	0	499	948
5:15PM	22	9	0	31	6	377	0	383	396	29	0	425	839
Total	94	33	0	127	21	1536	0	1557	1801	106	0	1907	3591
% Approach	74.0%	26.0%	0%	-	1.3%	98.7%	0%	-	94.4%	5.6%	0%	-	-
% Total	2.6%	0.9%	0%	3.5%	0.6%	42.8%	0%	43.4%	50.2%	3.0%	0%	53.1%	-
PHF	0.904	0.750	-	0.882	0.750	0.912	-	0.920	0.952	0.828	-	0.955	0.947
Lights	92	32	0	124	21	1506	0	1527	1771	106	0	1877	3528
% Lights	97.9%	97.0%	0%	97.6%	100%	98.0%	0%	98.1%	98.3%	100%	0%	98.4%	98.2%
Articulated Trucks	0	0	0	0	0	9	0	9	12	0	0	12	21
% Articulated Trucks	0%	0%	0%	0%	0%	0.6%	0%	0.6%	0.7%	0%	0%	0.6%	0.6%
Buses and Single-Unit Trucks	2	1	0	3	0	21	0	21	18	0	0	18	42
% Buses and Single-Unit Trucks	2.1%	3.0%	0%	2.4%	0%	1.4%	0%	1.3%	1.0%	0%	0%	0.9%	1.2%

* L: Left, R: Right, T: Thru, U: U-Turn

M-291 & Oldham Pkwy - TMC

Thu Oct 20, 2022

PM Peak (4:30 PM - 5:30 PM) - Overall Peak Hour

All Classes (Lights, Articulated Trucks, Buses and Single-Unit Trucks)

All Movements

ID: 1001814, Location: 38.900052, -94.375988



Provided by: Gewalt Hamilton Associates Inc.
625 Forest Edge Drive, Vernon Hills, IL, 60061, US

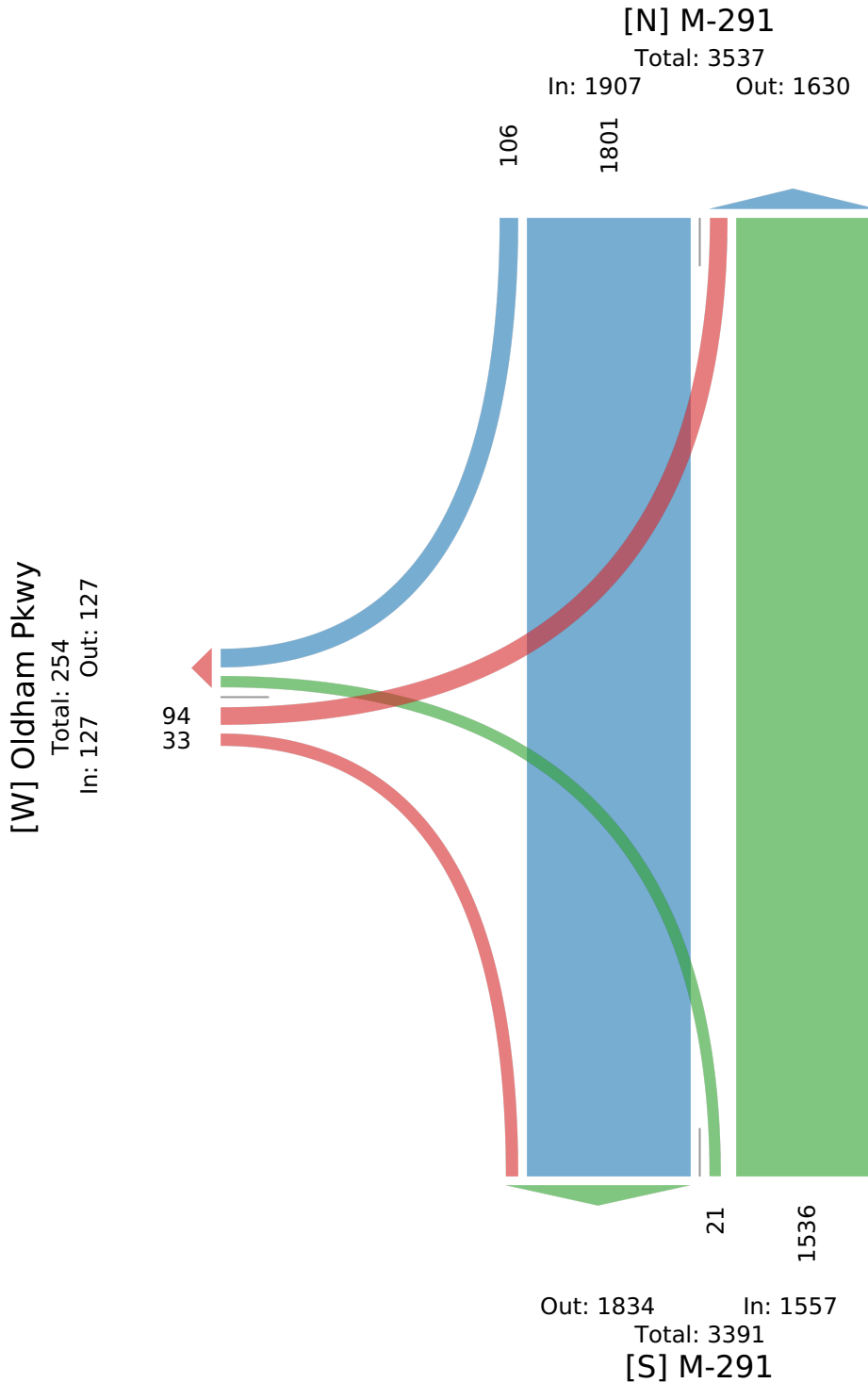

M-291 & Oldham Pkwy - TMC

Sat Oct 22, 2022

Full Length (12 PM-2 PM)

All Classes (Lights, Articulated Trucks, Buses and Single-Unit Trucks)

All Movements

ID: 1001809, Location: 38.900052, -94.375988



Provided by: Gewalt Hamilton Associates Inc.

625 Forest Edge Drive, Vernon Hills, IL, 60061, US

Leg Direction	Oldham Pkwy Eastbound				M-291 Northbound				M-291 Southbound				Int
	L	R	U	App	L	T	U	App	T	R	U	App	
2022-10-22 12:00PM	16	3	0	19	5	272	0	277	251	18	0	269	565
12:15PM	10	3	0	13	1	269	0	270	248	14	0	262	545
12:30PM	8	2	1	11	3	282	0	285	261	10	0	271	567
12:45PM	8	8	0	16	3	250	0	253	261	11	0	272	541
Hourly Total	42	16	1	59	12	1073	0	1085	1021	53	0	1074	2218
1:00PM	10	7	0	17	5	261	0	266	264	18	0	282	565
1:15PM	13	3	0	16	1	257	0	258	260	16	0	276	550
1:30PM	12	4	0	16	6	264	0	270	282	22	0	304	590
1:45PM	11	4	0	15	3	240	0	243	289	21	0	310	568
Hourly Total	46	18	0	64	15	1022	0	1037	1095	77	0	1172	2273
Total	88	34	1	123	27	2095	0	2122	2116	130	0	2246	4491
% Approach	71.5%	27.6%	0.8%	-	1.3%	98.7%	0%	-	94.2%	5.8%	0%	-	-
% Total	2.0%	0.8%	0%	2.7%	0.6%	46.6%	0%	47.3%	47.1%	2.9%	0%	50.0%	-
Lights	88	34	1	123	25	2065	0	2090	2088	130	0	2218	4431
% Lights	100%	100%	100%	100%	92.6%	98.6%	0%	98.5%	98.7%	100%	0%	98.8%	98.7%
Articulated Trucks	0	0	0	0	1	9	0	10	2	0	0	2	12
% Articulated Trucks	0%	0%	0%	0%	3.7%	0.4%	0%	0.5%	0.1%	0%	0%	0.1%	0.3%
Buses and Single-Unit Trucks	0	0	0	0	1	21	0	22	26	0	0	26	48
% Buses and Single-Unit Trucks	0%	0%	0%	0%	3.7%	1.0%	0%	1.0%	1.2%	0%	0%	1.2%	1.1%

*L: Left, R: Right, T: Thru, U: U-Turn

M-291 & Oldham Pkwy - TMC

Sat Oct 22, 2022

Full Length (12 PM-2 PM)

All Classes (Lights, Articulated Trucks, Buses and Single-Unit Trucks)

All Movements

ID: 1001809, Location: 38.900052, -94.375988



Provided by: Gewalt Hamilton Associates Inc.
625 Forest Edge Drive, Vernon Hills, IL, 60061, US

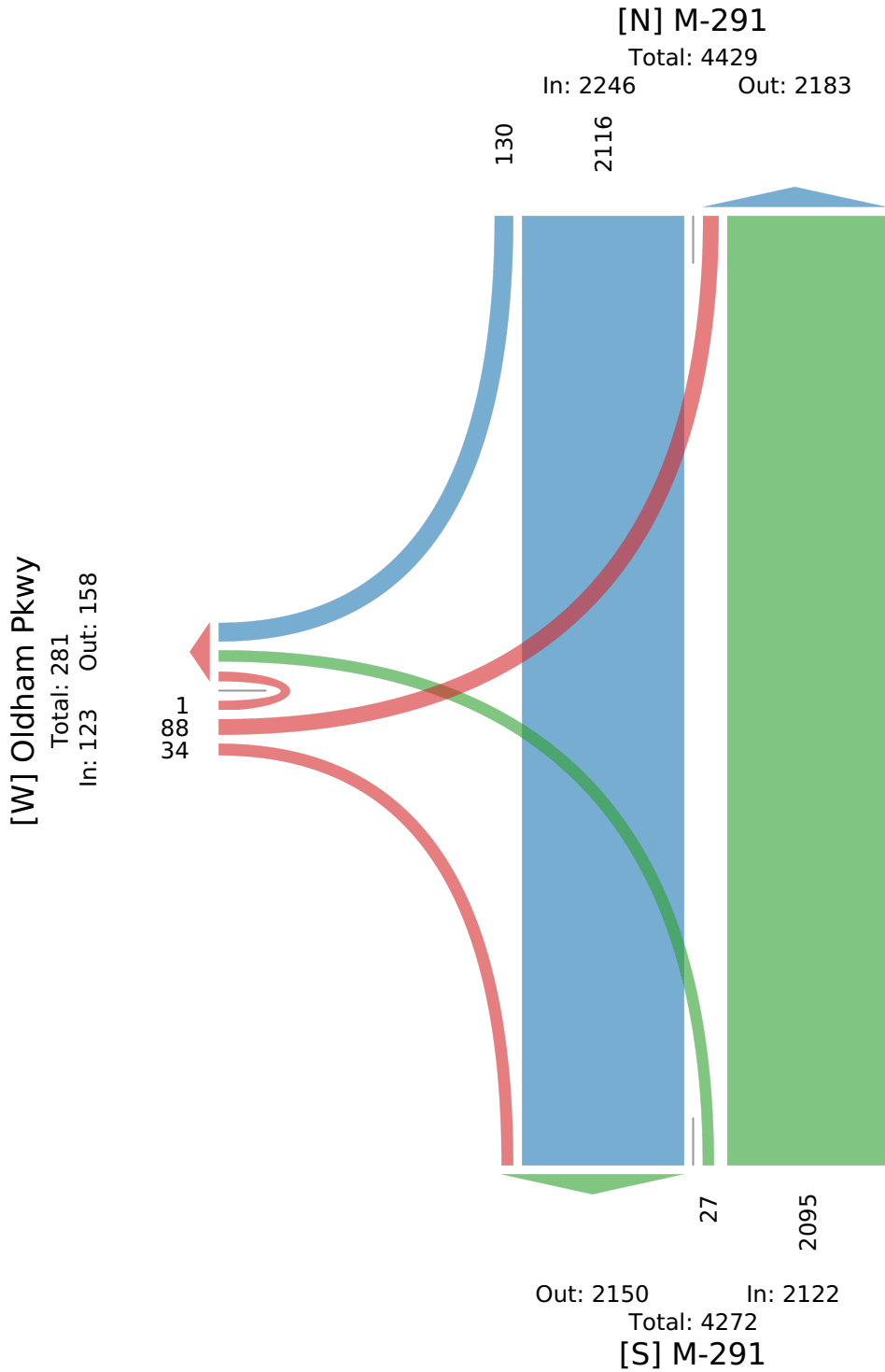

M-291 & Oldham Pkwy - TMC

Sat Oct 22, 2022

Midday Peak (WKND), PM Peak (WKND) (1 PM - 2 PM) - Overall Peak Hour

All Classes (Lights, Articulated Trucks, Buses and Single-Unit Trucks)

All Movements

ID: 1001809, Location: 38.900052, -94.375988



Provided by: Gewalt Hamilton Associates Inc.
625 Forest Edge Drive, Vernon Hills, IL, 60061, US

Leg Direction	Oldham Pkwy Eastbound				M-291 Northbound				M-291 Southbound				Int
	L	R	U	App	L	T	U	App	T	R	U	App	
2022-10-22 1:00PM	10	7	0	17	5	261	0	266	264	18	0	282	565
1:15PM	13	3	0	16	1	257	0	258	260	16	0	276	550
1:30PM	12	4	0	16	6	264	0	270	282	22	0	304	590
1:45PM	11	4	0	15	3	240	0	243	289	21	0	310	568
Total	46	18	0	64	15	1022	0	1037	1095	77	0	1172	2273
% Approach	71.9%	28.1%	0%	-	1.4%	98.6%	0%	-	93.4%	6.6%	0%	-	-
% Total	2.0%	0.8%	0%	2.8%	0.7%	45.0%	0%	45.6%	48.2%	3.4%	0%	51.6%	-
PHF	0.885	0.643	-	0.941	0.625	0.968	-	0.960	0.947	0.875	-	0.945	0.963
Lights	46	18	0	64	13	1014	0	1027	1079	77	0	1156	2247
% Lights	100%	100%	0%	100%	86.7%	99.2%	0%	99.0%	98.5%	100%	0%	98.6%	98.9%
Articulated Trucks	0	0	0	0	1	1	0	2	1	0	0	1	3
% Articulated Trucks	0%	0%	0%	0%	6.7%	0.1%	0%	0.2%	0.1%	0%	0%	0.1%	0.1%
Buses and Single-Unit Trucks	0	0	0	0	1	7	0	8	15	0	0	15	23
% Buses and Single-Unit Trucks	0%	0%	0%	0%	6.7%	0.7%	0%	0.8%	1.4%	0%	0%	1.3%	1.0%

*L: Left, R: Right, T: Thru, U: U-Turn

M-291 & Oldham Pkwy - TMC

Sat Oct 22, 2022

Midday Peak (WKND), PM Peak (WKND) (1 PM - 2 PM) - Overall Peak Hour

All Classes (Lights, Articulated Trucks, Buses and Single-Unit Trucks)

All Movements

ID: 1001809, Location: 38.900052, -94.375988



Provided by: Gewalt Hamilton Associates Inc.
625 Forest Edge Drive, Vernon Hills, IL, 60061, US

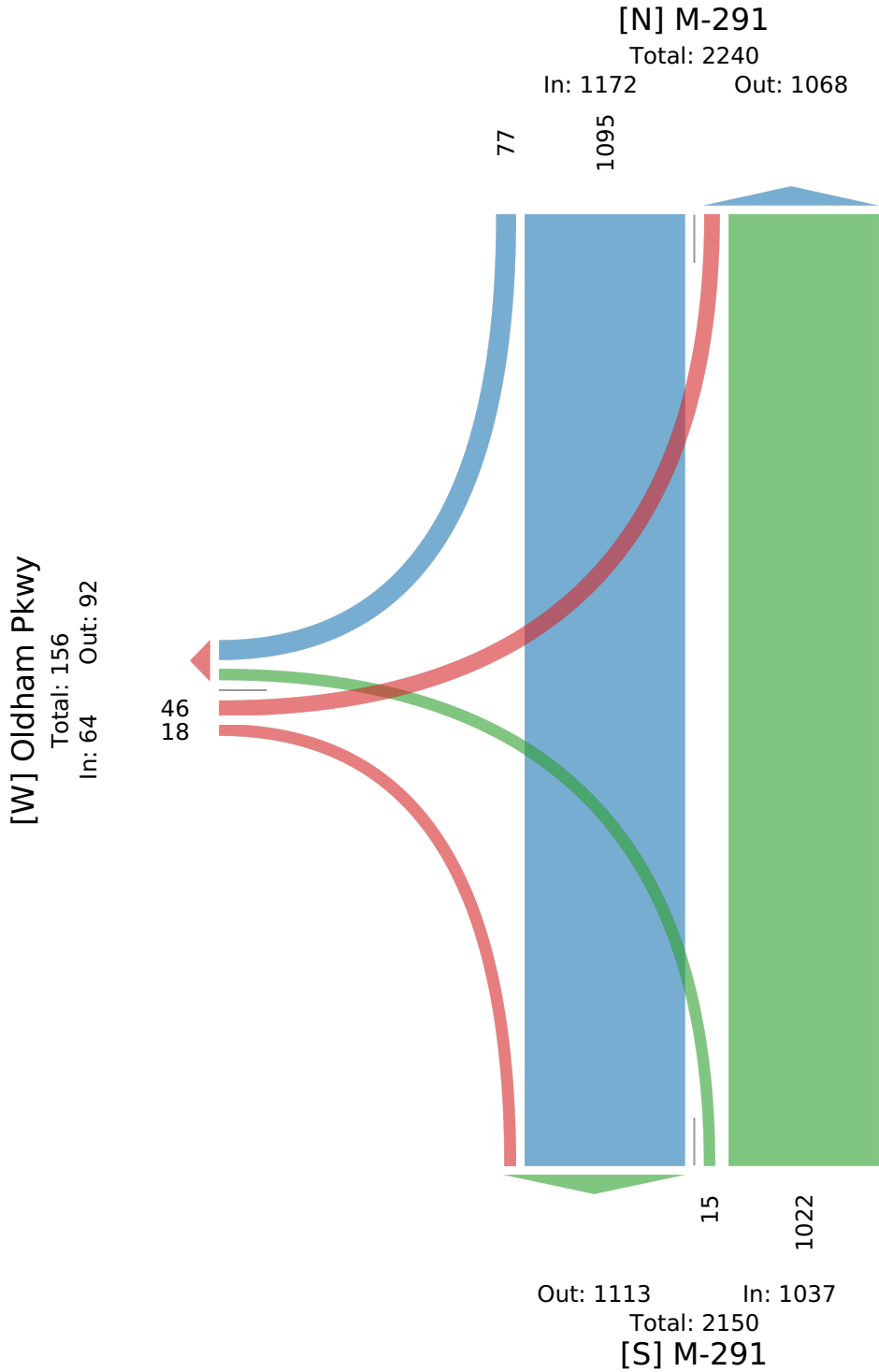

Persels Rd & Jefferson St - TMC

Thu Oct 20, 2022

Full Length (7 AM-9 AM, 4 PM-6 PM)

All Classes (Lights, Articulated Trucks, Buses and Single-Unit Trucks)

All Movements

ID: 1001817, Location: 38.896048, -94.377434



Provided by: Gewalt Hamilton Associates Inc.

625 Forest Edge Drive, Vernon Hills, IL, 60061, US

Leg Direction	Persels Rd Eastbound					Persels Rd Westbound					Jefferson St Northbound					Jefferson St Southbound					
Time	L	T	R	U	App	L	T	R	U	App	L	T	R	U	App	L	T	R	U	App	Int
2022-10-20 7:00AM	3	58	5	0	66	49	39	2	0	90	3	0	28	0	31	0	10	1	0	11	198
7:15AM	1	40	10	0	51	82	43	3	0	128	5	15	35	0	55	4	48	3	0	55	289
7:30AM	0	34	6	0	40	59	40	8	0	107	7	20	68	0	95	3	56	5	0	64	306
7:45AM	0	43	7	0	50	58	48	5	0	111	0	5	22	0	27	2	26	3	0	31	219
Hourly Total	4	175	28	0	207	248	170	18	0	436	15	40	153	0	208	9	140	12	0	161	1012
8:00AM	3	68	10	0	81	71	47	3	0	121	3	12	39	0	54	4	49	4	0	57	313
8:15AM	1	51	5	0	57	31	34	3	0	68	1	22	36	0	59	0	8	3	0	11	195
8:30AM	1	28	4	0	33	16	32	2	0	50	1	2	17	0	20	3	6	2	0	11	114
8:45AM	0	40	3	0	43	10	24	8	0	42	6	1	17	0	24	3	5	1	0	9	118
Hourly Total	5	187	22	0	214	128	137	16	0	281	11	37	109	0	157	10	68	10	0	88	740
4:00PM	2	46	3	0	51	37	45	4	0	86	0	3	31	0	34	5	11	7	0	23	194
4:15PM	1	55	3	0	59	39	73	2	0	114	3	6	24	0	33	2	16	7	0	25	231
4:30PM	3	57	5	0	65	35	64	5	0	104	4	17	40	0	61	5	12	6	0	23	253
4:45PM	2	49	6	0	57	34	47	3	0	84	7	7	37	0	51	4	9	5	0	18	210
Hourly Total	8	207	17	0	232	145	229	14	0	388	14	33	132	0	179	16	48	25	0	89	888
5:00PM	0	52	2	0	54	43	60	6	0	109	4	7	59	0	70	3	12	3	0	18	251
5:15PM	0	43	2	0	45	26	55	6	0	87	5	10	38	0	53	4	10	5	0	19	204
5:30PM	0	46	2	0	48	16	49	4	0	69	1	6	27	0	34	4	8	2	0	14	165
5:45PM	0	38	5	0	43	26	50	5	0	81	1	1	15	0	17	2	10	4	0	16	157
Hourly Total	0	179	11	0	190	111	214	21	0	346	11	24	139	0	174	13	40	14	0	67	777
Total	17	748	78	0	843	632	750	69	0	1451	51	134	533	0	718	48	296	61	0	405	3417
% Approach	2.0%	88.7%	9.3%	0%	-	43.6%	51.7%	4.8%	0%	-	7.1%	18.7%	74.2%	0%	-	11.9%	73.1%	15.1%	0%	-	-
% Total	0.5%	21.9%	2.3%	0%	24.7%	18.5%	21.9%	2.0%	0%	42.5%	1.5%	3.9%	15.6%	0%	21.0%	1.4%	8.7%	1.8%	0%	11.9%	-
Lights	17	715	73	0	805	625	721	64	0	1410	48	134	526	0	708	47	289	60	0	396	3319
% Lights	100%	95.6%	93.6%	0%	95.5%	98.9%	96.1%	92.8%	0%	97.2%	94.1%	100%	98.7%	0%	98.6%	97.9%	97.6%	98.4%	0%	97.8%	97.1%
Articulated Trucks	0	0	0	0	0	3	0	2	0	5	0	0	3	0	3	0	2	0	0	2	10
% Articulated Trucks	0%	0%	0%	0%	0%	0.5%	0%	2.9%	0%	0.3%	0%	0%	0.6%	0%	0.4%	0%	0.7%	0%	0%	0.5%	0.3%
Buses and Single-Unit Trucks	0	33	5	0	38	4	29	3	0	36	3	0	4	0	7	1	5	1	0	7	88
% Buses and Single-Unit Trucks	0%	4.4%	6.4%	0%	4.5%	0.6%	3.9%	4.3%	0%	2.5%	5.9%	0%	0.8%	0%	1.0%	2.1%	1.7%	1.6%	0%	1.7%	2.6%

*L: Left, R: Right, T: Thru, U: U-Turn

Persels Rd & Jefferson St - TMC

Thu Oct 20, 2022

Full Length (7 AM-9 AM, 4 PM-6 PM)

All Classes (Lights, Articulated Trucks, Buses and Single-Unit Trucks)

All Movements

ID: 1001817, Location: 38.896048, -94.377434



Provided by: Gewalt Hamilton Associates Inc.
625 Forest Edge Drive, Vernon Hills, IL, 60061, US

[N] Jefferson St

Total: 625

In: 405 Out: 220

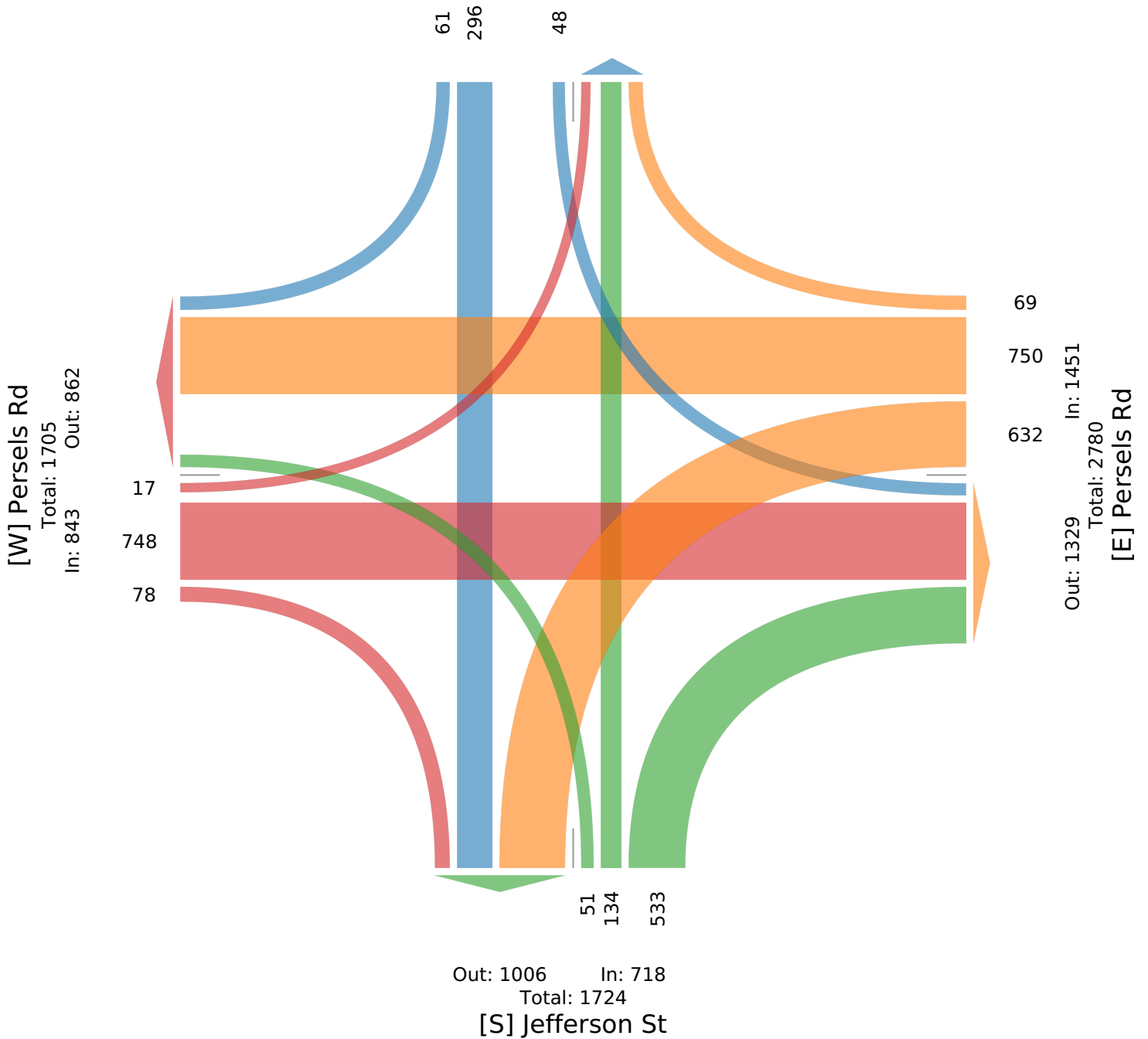

Persels Rd & Jefferson St - TMC

Thu Oct 20, 2022

AM Peak (7:15 AM - 8:15 AM) - Overall Peak Hour

All Classes (Lights, Articulated Trucks, Buses and Single-Unit Trucks)

All Movements

ID: 1001817, Location: 38.896048, -94.377434



Provided by: Gewalt Hamilton Associates Inc.

625 Forest Edge Drive, Vernon Hills, IL, 60061, US

Leg Direction	Persels Rd Eastbound					Persels Rd Westbound					Jefferson St Northbound					Jefferson St Southbound					
Time	L	T	R	U	App	L	T	R	U	App	L	T	R	U	App	L	T	R	U	App	Int
2022-10-20 7:15AM	1	40	10	0	51	82	43	3	0	128	5	15	35	0	55	4	48	3	0	55	289
7:30AM	0	34	6	0	40	59	40	8	0	107	7	20	68	0	95	3	56	5	0	64	306
7:45AM	0	43	7	0	50	58	48	5	0	111	0	5	22	0	27	2	26	3	0	31	219
8:00AM	3	68	10	0	81	71	47	3	0	121	3	12	39	0	54	4	49	4	0	57	313
Total	4	185	33	0	222	270	178	19	0	467	15	52	164	0	231	13	179	15	0	207	1127
% Approach	1.8%	83.3%	14.9%	0%	-	57.8%	38.1%	4.1%	0%	-	6.5%	22.5%	71.0%	0%	-	6.3%	86.5%	7.2%	0%	-	-
% Total	0.4%	16.4%	2.9%	0%	19.7%	24.0%	15.8%	1.7%	0%	41.4%	1.3%	4.6%	14.6%	0%	20.5%	1.2%	15.9%	1.3%	0%	18.4%	-
PHF	0.333	0.680	0.825	-	0.685	0.823	0.927	0.594	-	0.912	0.536	0.650	0.603	-	0.608	0.813	0.799	0.750	-	0.809	0.900
Lights	4	182	32	0	218	268	171	16	0	455	15	52	163	0	230	13	176	15	0	204	1107
% Lights	100%	98.4%	97.0%	0%	98.2%	99.3%	96.1%	84.2%	0%	97.4%	100%	100%	99.4%	0%	99.6%	100%	98.3%	100%	0%	98.6%	98.2%
Articulated Trucks	0	0	0	0	0	1	0	2	0	3	0	0	1	0	1	0	0	0	0	0	4
% Articulated Trucks	0%	0%	0%	0%	0%	0.4%	0%	10.5%	0%	0.6%	0%	0%	0.6%	0%	0.4%	0%	0%	0%	0%	0%	0.4%
Buses and Single-Unit Trucks	0	3	1	0	4	1	7	1	0	9	0	0	0	0	0	0	3	0	0	3	16
% Buses and Single-Unit Trucks	0%	1.6%	3.0%	0%	1.8%	0.4%	3.9%	5.3%	0%	1.9%	0%	0%	0%	0%	0%	0%	1.7%	0%	0%	1.4%	1.4%

* L: Left, R: Right, T: Thru, U: U-Turn

Persels Rd & Jefferson St - TMC

Thu Oct 20, 2022

AM Peak (7:15 AM - 8:15 AM) - Overall Peak Hour

All Classes (Lights, Articulated Trucks, Buses and Single-Unit Trucks)

All Movements

ID: 1001817, Location: 38.896048, -94.377434



Provided by: Gewalt Hamilton Associates Inc.
625 Forest Edge Drive, Vernon Hills, IL, 60061, US

[N] Jefferson St

Total: 282

In: 207 Out: 75

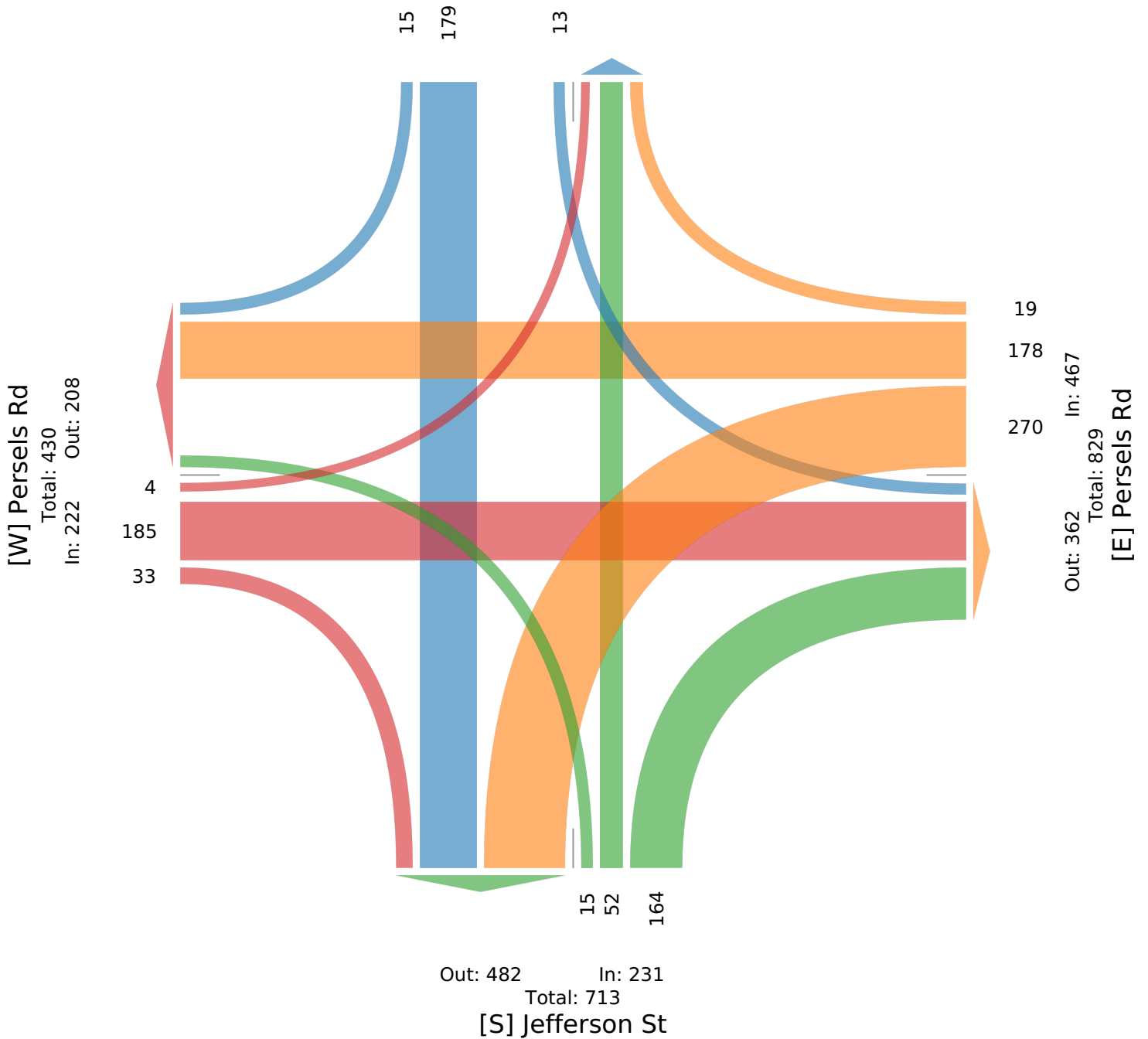

Persels Rd & Jefferson St - TMC

Thu Oct 20, 2022

PM Peak (4:15 PM - 5:15 PM)

All Classes (Lights, Articulated Trucks, Buses and Single-Unit Trucks)

All Movements

ID: 1001817, Location: 38.896048, -94.377434



Provided by: Gewalt Hamilton Associates Inc.

625 Forest Edge Drive, Vernon Hills, IL, 60061, US

Leg Direction	Persels Rd Eastbound					Persels Rd Westbound					Jefferson St Northbound					Jefferson St Southbound					Int
	L	T	R	U	App	L	T	R	U	App	L	T	R	U	App	L	T	R	U	App	
2022-10-20 4:15PM	1	55	3	0	59	39	73	2	0	114	3	6	24	0	33	2	16	7	0	25	231
4:30PM	3	57	5	0	65	35	64	5	0	104	4	17	40	0	61	5	12	6	0	23	253
4:45PM	2	49	6	0	57	34	47	3	0	84	7	7	37	0	51	4	9	5	0	18	210
5:00PM	0	52	2	0	54	43	60	6	0	109	4	7	59	0	70	3	12	3	0	18	251
Total	6	213	16	0	235	151	244	16	0	411	18	37	160	0	215	14	49	21	0	84	945
% Approach	2.6%	90.6%	6.8%	0%	-	36.7%	59.4%	3.9%	0%	-	8.4%	17.2%	74.4%	0%	-	16.7%	58.3%	25.0%	0%	-	-
% Total	0.6%	22.5%	1.7%	0%	24.9%	16.0%	25.8%	1.7%	0%	43.5%	1.9%	3.9%	16.9%	0%	22.8%	1.5%	5.2%	2.2%	0%	8.9%	-
PHF	0.500	0.934	0.667	-	0.904	0.878	0.836	0.667	-	0.901	0.643	0.544	0.678	-	0.768	0.700	0.766	0.750	-	0.840	0.934
Lights	6	196	16	0	218	148	241	16	0	405	16	37	160	0	213	14	48	21	0	83	919
% Lights	100%	92.0%	100%	0%	92.8%	98.0%	98.8%	100%	0%	98.5%	88.9%	100%	100%	0%	99.1%	100%	98.0%	100%	0%	98.8%	97.2%
Articulated Trucks	0	0	0	0	0	1	0	0	0	1	0	0	0	0	0	0	0	0	0	0	1
% Articulated Trucks	0%	0%	0%	0%	0%	0.7%	0%	0%	0%	0.2%	0%	0%	0%	0%	0%	0%	0%	0%	0%	0%	0.1%
Buses and Single-Unit Trucks	0	17	0	0	17	2	3	0	0	5	2	0	0	0	2	0	1	0	0	1	25
% Buses and Single-Unit Trucks	0%	8.0%	0%	0%	7.2%	1.3%	1.2%	0%	0%	1.2%	11.1%	0%	0%	0%	0.9%	0%	2.0%	0%	0%	1.2%	2.6%

* L: Left, R: Right, T: Thru, U: U-Turn

Persels Rd & Jefferson St - TMC

Thu Oct 20, 2022

PM Peak (4:15 PM - 5:15 PM)

All Classes (Lights, Articulated Trucks, Buses and Single-Unit Trucks)

All Movements

ID: 1001817, Location: 38.896048, -94.377434



Provided by: Gewalt Hamilton Associates Inc.
625 Forest Edge Drive, Vernon Hills, IL, 60061, US

[N] Jefferson St

Total: 143

In: 84 Out: 59

[W] Persels Rd

Total: 518

In: 235 Out: 283

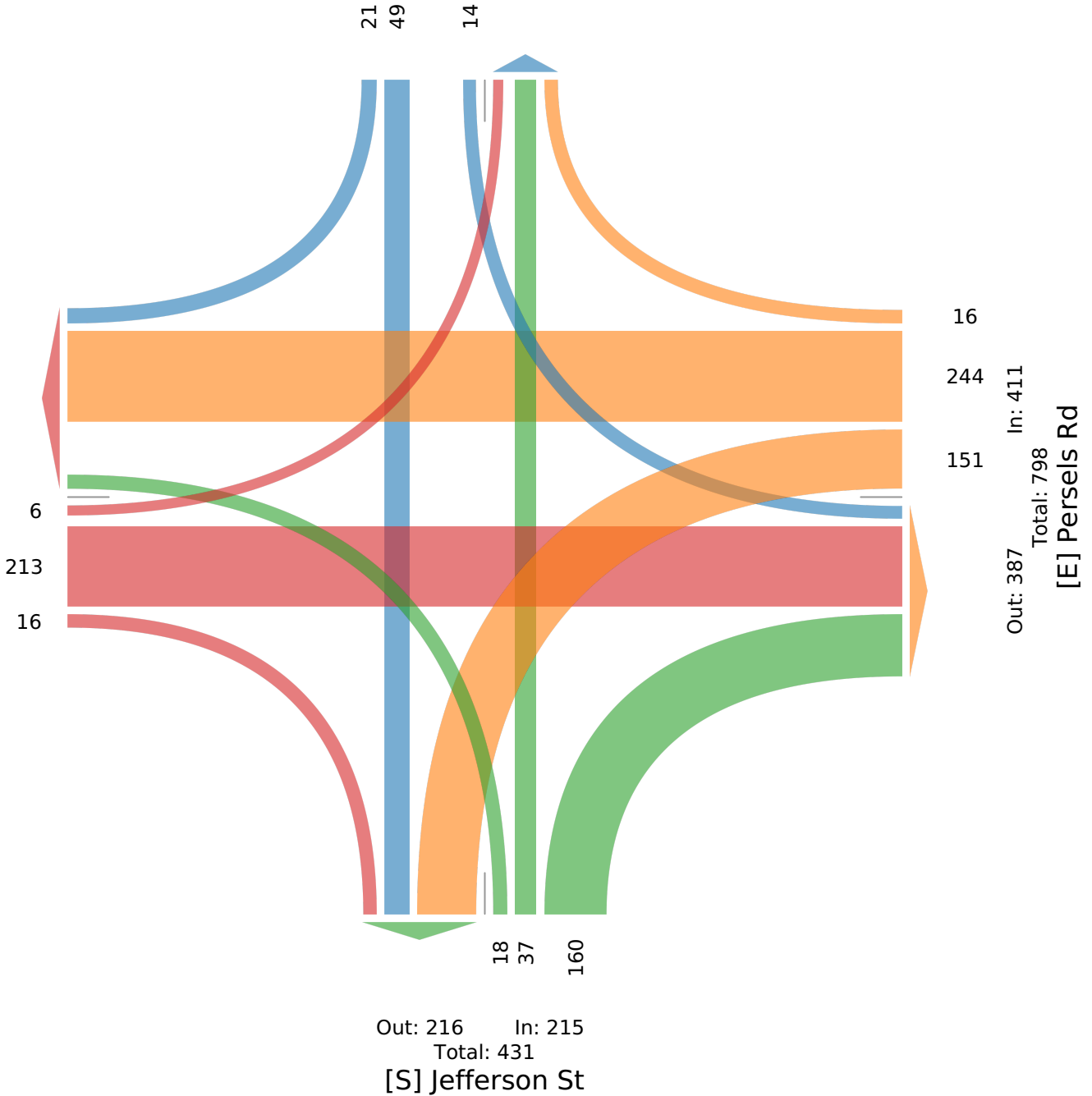

Persels Rd & Jefferson St - TMC

Sat Oct 22, 2022

Full Length (12 PM-2 PM)

All Classes (Lights, Articulated Trucks, Buses and Single-Unit Trucks)

All Movements

ID: 1001813, Location: 38.896048, -94.377434



Provided by: Gewalt Hamilton Associates Inc.
625 Forest Edge Drive, Vernon Hills, IL, 60061, US

Leg Direction	Persels Rd Eastbound					Persels Rd Westbound					Jefferson St Northbound					Jefferson St Southbound					
Time	L	T	R	U	App	L	T	R	U	App	L	T	R	U	App	L	T	R	U	App	Int
2022-10-22 12:00PM	0	30	1	0	31	10	36	2	0	48	3	5	19	0	27	2	5	3	0	10	116
12:15PM	0	21	0	0	21	11	26	1	0	38	1	1	8	0	10	0	4	1	0	5	74
12:30PM	0	38	1	0	39	15	40	3	0	58	2	3	10	0	15	0	3	2	0	5	117
12:45PM	0	35	1	0	36	11	36	2	0	49	3	5	10	0	18	2	5	3	0	10	113
Hourly Total	0	124	3	0	127	47	138	8	0	193	9	14	47	0	70	4	17	9	0	30	420
1:00PM	0	27	0	0	27	12	23	3	0	38	1	2	7	0	10	2	5	2	0	9	84
1:15PM	0	40	0	0	40	13	24	2	0	39	2	0	7	0	9	1	1	0	0	2	90
1:30PM	0	30	1	0	31	10	23	1	0	34	3	2	12	0	17	5	5	2	0	12	94
1:45PM	0	33	0	0	33	12	41	2	0	55	2	1	15	0	18	2	3	2	0	7	113
Hourly Total	0	130	1	0	131	47	111	8	0	166	8	5	41	0	54	10	14	6	0	30	381
Total	0	254	4	0	258	94	249	16	0	359	17	19	88	0	124	14	31	15	0	60	801
% Approach	0%	98.4%	1.6%	0%	-	26.2%	69.4%	4.5%	0%	-	13.7%	15.3%	71.0%	0%	-	23.3%	51.7%	25.0%	0%	-	-
% Total	0%	31.7%	0.5%	0%	32.2%	11.7%	31.1%	2.0%	0%	44.8%	2.1%	2.4%	11.0%	0%	15.5%	1.7%	3.9%	1.9%	0%	7.5%	-
Lights	0	253	4	0	257	91	248	16	0	355	17	19	87	0	123	14	31	15	0	60	795
% Lights	0%	99.6%	100%	0%	99.6%	96.8%	99.6%	100%	0%	98.9%	100%	100%	98.9%	0%	99.2%	100%	100%	100%	0%	100%	99.3%
Articulated Trucks	0	0	0	0	0	0	0	0	0	0	0	0	0	0	0	0	0	0	0	0	0
% Articulated Trucks	0%	0%	0%	0%	0%	0%	0%	0%	0%	0%	0%	0%	0%	0%	0%	0%	0%	0%	0%	0%	0%
Buses and Single-Unit Trucks	0	1	0	0	1	3	1	0	0	4	0	0	1	0	1	0	0	0	0	0	6
% Buses and Single-Unit Trucks	0%	0.4%	0%	0%	0.4%	3.2%	0.4%	0%	0%	1.1%	0%	0%	1.1%	0%	0.8%	0%	0%	0%	0%	0%	0.7%

*L: Left, R: Right, T: Thru, U: U-Turn

Persels Rd & Jefferson St - TMC

Sat Oct 22, 2022

Full Length (12 PM-2 PM)

All Classes (Lights, Articulated Trucks, Buses and Single-Unit Trucks)

All Movements

ID: 1001813, Location: 38.896048, -94.377434



Provided by: Gewalt Hamilton Associates Inc.
625 Forest Edge Drive, Vernon Hills, IL, 60061, US

[N] Jefferson St

Total: 95

In: 60 Out: 35

15 31 14

[W] Persels Rd
Total: 539
In: 258 Out: 281

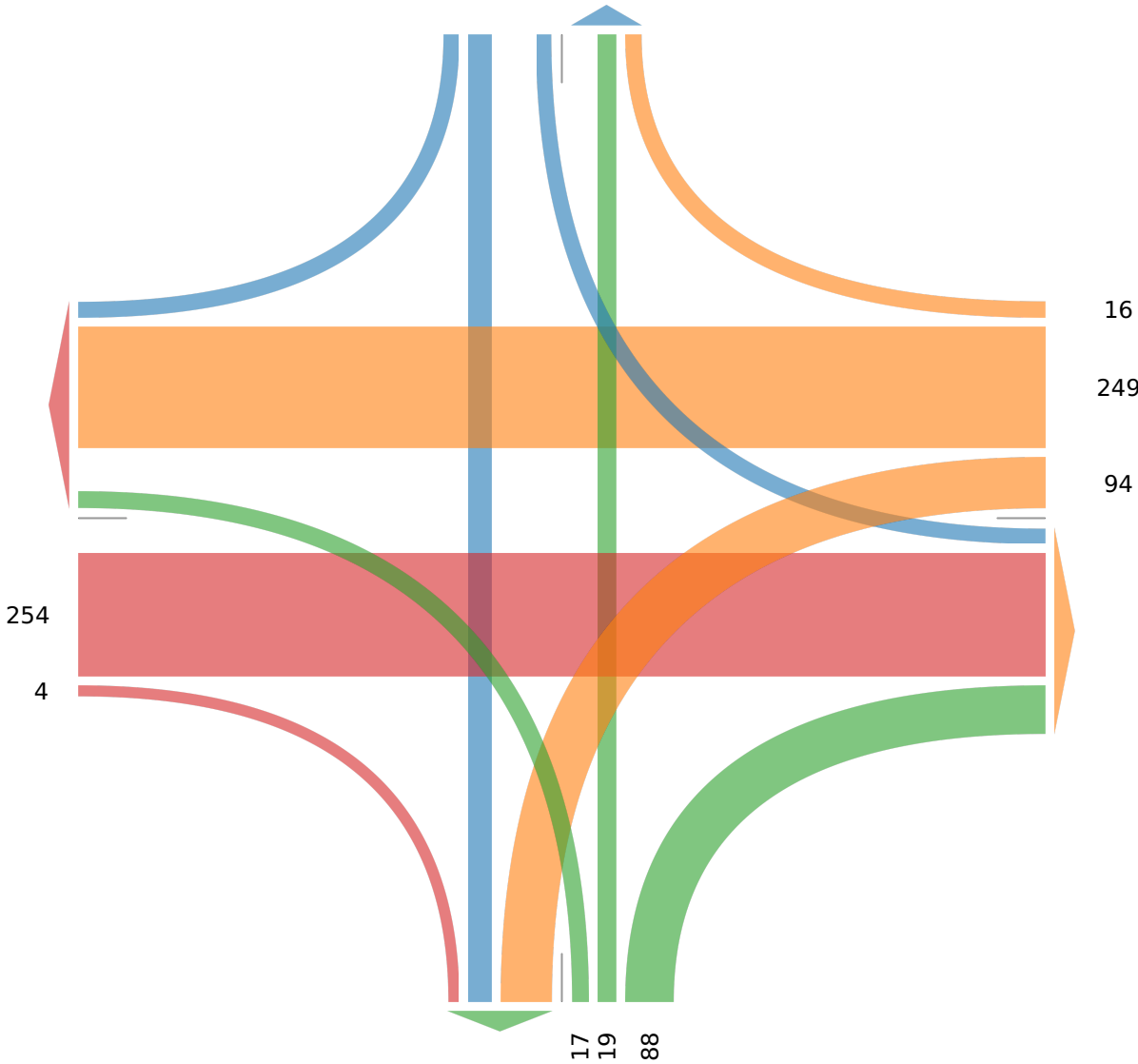

[E] Persels Rd
Total: 715
In: 359
Out: 356

Out: 129 In: 124
Total: 253

[S] Jefferson St

Persels Rd & Jefferson St - TMC

Sat Oct 22, 2022

Midday Peak (WKND) (12 PM - 1 PM) - Overall Peak Hour

All Classes (Lights, Articulated Trucks, Buses and Single-Unit Trucks)

All Movements

ID: 1001813, Location: 38.896048, -94.377434



Provided by: Gewalt Hamilton Associates Inc.

625 Forest Edge Drive, Vernon Hills, IL, 60061, US

Leg Direction	Persels Rd Eastbound					Persels Rd Westbound					Jefferson St Northbound					Jefferson St Southbound					Int
	L	T	R	U	App	L	T	R	U	App	L	T	R	U	App	L	T	R	U	App	
2022-10-22 12:00PM	0	30	1	0	31	10	36	2	0	48	3	5	19	0	27	2	5	3	0	10	116
12:15PM	0	21	0	0	21	11	26	1	0	38	1	1	8	0	10	0	4	1	0	5	74
12:30PM	0	38	1	0	39	15	40	3	0	58	2	3	10	0	15	0	3	2	0	5	117
12:45PM	0	35	1	0	36	11	36	2	0	49	3	5	10	0	18	2	5	3	0	10	113
Total	0	124	3	0	127	47	138	8	0	193	9	14	47	0	70	4	17	9	0	30	420
% Approach	0%	97.6%	2.4%	0%	-	24.4%	71.5%	4.1%	0%	-	12.9%	20.0%	67.1%	0%	-	13.3%	56.7%	30.0%	0%	-	-
% Total	0%	29.5%	0.7%	0%	30.2%	11.2%	32.9%	1.9%	0%	46.0%	2.1%	3.3%	11.2%	0%	16.7%	1.0%	4.0%	2.1%	0%	7.1%	-
PHF	-	0.816	0.750	-	0.814	0.783	0.863	0.667	-	0.832	0.750	0.700	0.618	-	0.648	0.500	0.850	0.750	-	0.750	0.897
Lights	0	123	3	0	126	47	137	8	0	192	9	14	46	0	69	4	17	9	0	30	417
% Lights	0%	99.2%	100%	0%	99.2%	100%	99.3%	100%	0%	99.5%	100%	100%	97.9%	0%	98.6%	100%	100%	100%	0%	100%	99.3%
Articulated Trucks	0	0	0	0	0	0	0	0	0	0	0	0	0	0	0	0	0	0	0	0	0
% Articulated Trucks	0%	0%	0%	0%	0%	0%	0%	0%	0%	0%	0%	0%	0%	0%	0%	0%	0%	0%	0%	0%	0%
Buses and Single-Unit Trucks	0	1	0	0	1	0	1	0	0	1	0	0	1	0	1	0	0	0	0	0	3
% Buses and Single-Unit Trucks	0%	0.8%	0%	0%	0.8%	0%	0.7%	0%	0%	0.5%	0%	0%	2.1%	0%	1.4%	0%	0%	0%	0%	0%	0.7%

* L: Left, R: Right, T: Thru, U: U-Turn

Persels Rd & Jefferson St - TMC

Sat Oct 22, 2022

Midday Peak (WKND) (12 PM - 1 PM) - Overall Peak Hour

All Classes (Lights, Articulated Trucks, Buses and Single-Unit Trucks)

All Movements

ID: 1001813, Location: 38.896048, -94.377434



Provided by: Gewalt Hamilton Associates Inc.
625 Forest Edge Drive, Vernon Hills, IL, 60061, US

[N] Jefferson St

Total: 52

In: 30 Out: 22

9 17 4

[W] Persels Rd
Total: 283
In: 127 Out: 156

124
3

8
138
47

In: 193
Total: 368
Out: 175
[E] Persels Rd

Out: 67 In: 70
Total: 137

[S] Jefferson St

9 14 47

Persels Rd & Jefferson St - TMC

Sat Oct 22, 2022

PM Peak (WKND) (1 PM - 2 PM)

All Classes (Lights, Articulated Trucks, Buses and Single-Unit Trucks)

All Movements

ID: 1001813, Location: 38.896048, -94.377434



Provided by: Gewalt Hamilton Associates Inc.

625 Forest Edge Drive, Vernon Hills, IL, 60061, US

Leg Direction	Persels Rd Eastbound					Persels Rd Westbound					Jefferson St Northbound					Jefferson St Southbound					Int
	L	T	R	U	App	L	T	R	U	App	L	T	R	U	App	L	T	R	U	App	
2022-10-22 1:00PM	0	27	0	0	27	12	23	3	0	38	1	2	7	0	10	2	5	2	0	9	84
1:15PM	0	40	0	0	40	13	24	2	0	39	2	0	7	0	9	1	1	0	0	2	90
1:30PM	0	30	1	0	31	10	23	1	0	34	3	2	12	0	17	5	5	2	0	12	94
1:45PM	0	33	0	0	33	12	41	2	0	55	2	1	15	0	18	2	3	2	0	7	113
Total	0	130	1	0	131	47	111	8	0	166	8	5	41	0	54	10	14	6	0	30	381
% Approach	0%	99.2%	0.8%	0%	-	28.3%	66.9%	4.8%	0%	-	14.8%	9.3%	75.9%	0%	-	33.3%	46.7%	20.0%	0%	-	-
% Total	0%	34.1%	0.3%	0%	34.4%	12.3%	29.1%	2.1%	0%	43.6%	2.1%	1.3%	10.8%	0%	14.2%	2.6%	3.7%	1.6%	0%	7.9%	-
PHF	-	0.813	0.250	-	0.819	0.904	0.677	0.667	-	0.755	0.667	0.625	0.683	-	0.750	0.500	0.700	0.750	-	0.625	0.843
Lights	0	130	1	0	131	44	111	8	0	163	8	5	41	0	54	10	14	6	0	30	378
% Lights	0%	100%	100%	0%	100%	93.6%	100%	100%	0%	98.2%	100%	100%	100%	0%	100%	100%	100%	100%	0%	100%	99.2%
Articulated Trucks	0	0	0	0	0	0	0	0	0	0	0	0	0	0	0	0	0	0	0	0	0
% Articulated Trucks	0%	0%	0%	0%	0%	0%	0%	0%	0%	0%	0%	0%	0%	0%	0%	0%	0%	0%	0%	0%	0%
Buses and Single-Unit Trucks	0	0	0	0	0	3	0	0	0	3	0	0	0	0	0	0	0	0	0	0	3
% Buses and Single-Unit Trucks	0%	0%	0%	0%	0%	6.4%	0%	0%	0%	1.8%	0%	0%	0%	0%	0%	0%	0%	0%	0%	0%	0.8%

* L: Left, R: Right, T: Thru, U: U-Turn

Persels Rd & Jefferson St - TMC

Sat Oct 22, 2022

PM Peak (WKND) (1 PM - 2 PM)

All Classes (Lights, Articulated Trucks, Buses and Single-Unit Trucks)

All Movements

ID: 1001813, Location: 38.896048, -94.377434



Provided by: Gewalt Hamilton Associates Inc.
625 Forest Edge Drive, Vernon Hills, IL, 60061, US

[N] Jefferson St

Total: 43

In: 30 Out: 13

6 14 10

[W] Persels Rd
Total: 256
In: 131 Out: 125

130
1

8
111
47
Out: 181 In: 166
Total: 347

[E] Persels Rd

Out: 62 In: 54
Total: 116

[S] Jefferson St

8 5 41

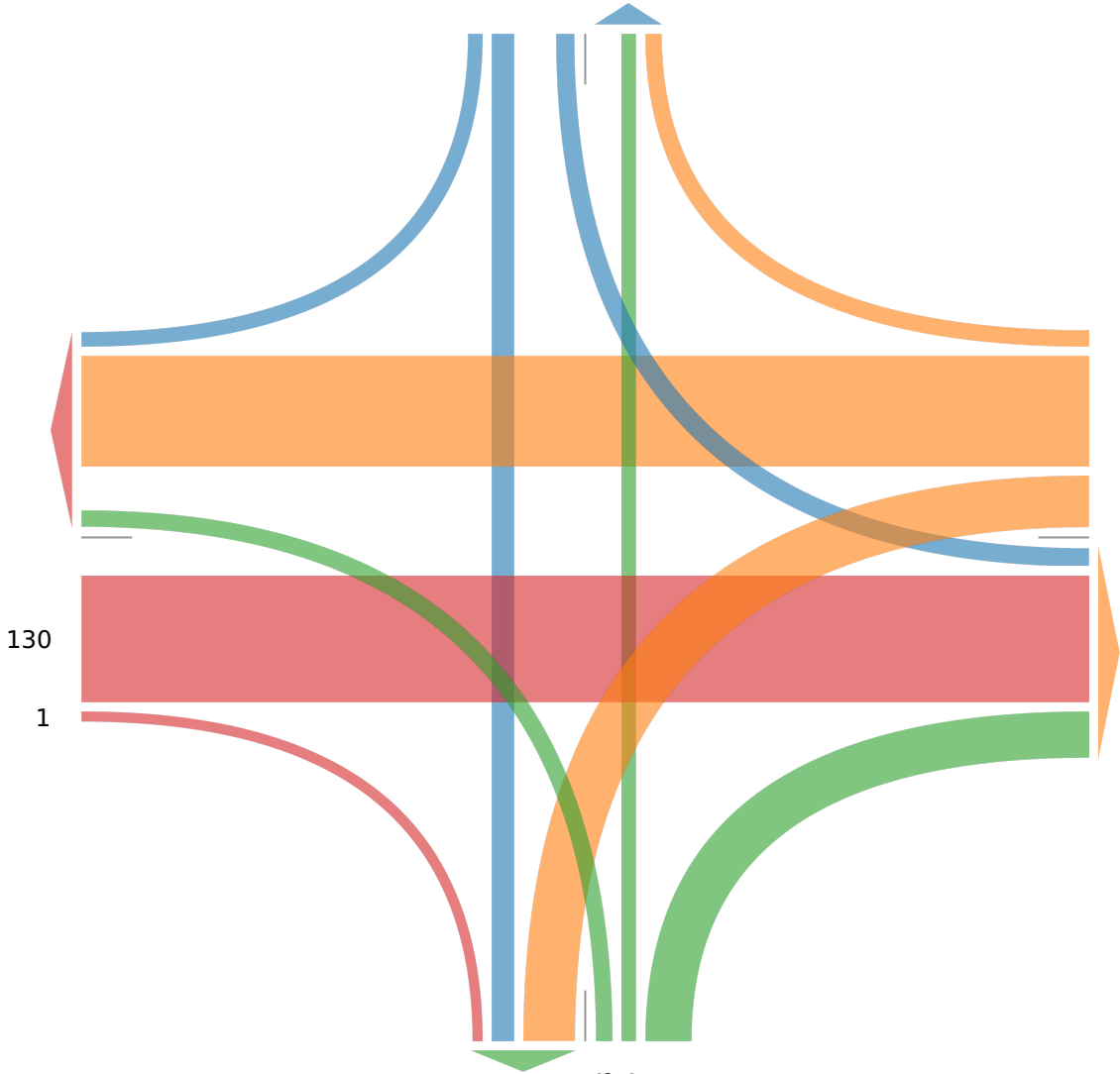

M-291 & Persels Rd - TMC

Thu Oct 20, 2022

Full Length (7 AM-9 AM, 4 PM-6 PM)

All Classes (Lights, Articulated Trucks, Buses and Single-Unit Trucks)

All Movements

ID: 1001816, Location: 38.89606, -94.375421



Provided by: Gewalt Hamilton Associates Inc.

625 Forest Edge Drive, Vernon Hills, IL, 60061, US

Leg Direction	Persels Rd Eastbound					Persels Rd Westbound					M-291 Northbound					M-291 Southbound					Int
	L	T	R	U	App	L	T	R	U	App	L	T	R	U	App	L	T	R	U	App	
2022-10-20 7:00AM	73	10	4	0	87	25	26	8	0	59	4	365	56	0	425	5	168	73	0	246	817
7:15AM	72	17	3	0	92	44	30	12	0	86	13	319	53	0	385	4	210	100	1	315	878
7:30AM	63	34	4	0	101	36	25	10	0	71	9	391	83	0	483	3	238	85	0	326	981
7:45AM	46	19	6	0	71	51	34	8	0	93	14	301	74	1	390	13	234	80	1	328	882
Hourly Total	254	80	17	0	351	156	115	38	0	309	40	1376	266	1	1683	25	850	338	2	1215	3558
8:00AM	65	21	11	0	97	43	36	10	0	89	6	332	58	1	397	5	209	101	1	316	899
8:15AM	68	35	10	0	113	56	21	14	0	91	4	258	66	0	328	4	169	42	1	216	748
8:30AM	34	14	5	0	53	47	26	11	0	84	7	239	44	1	291	5	203	40	1	249	677
8:45AM	40	24	6	0	70	42	26	6	0	74	5	249	53	0	307	6	178	26	0	210	661
Hourly Total	207	94	32	0	333	188	109	41	0	338	22	1078	221	2	1323	20	759	209	3	991	2985
4:00PM	63	25	8	0	96	66	27	20	0	113	12	250	65	0	327	3	348	62	0	413	949
4:15PM	68	29	5	0	102	85	38	17	0	140	12	267	61	0	340	7	312	90	0	409	991
4:30PM	76	33	11	0	120	87	32	21	0	140	12	321	76	0	409	12	443	73	1	529	1198
4:45PM	81	39	10	0	130	75	27	16	0	118	9	260	77	0	346	6	389	70	0	465	1059
Hourly Total	288	126	34	0	448	313	124	74	0	511	45	1098	279	0	1422	28	1492	295	1	1816	4197
5:00PM	86	30	9	0	125	81	42	22	0	145	11	313	54	0	378	4	418	68	1	491	1139
5:15PM	82	29	6	0	117	77	38	16	0	131	8	282	42	0	332	7	346	48	1	402	982
5:30PM	52	21	10	0	83	63	29	8	0	100	14	339	54	1	408	2	336	45	3	386	977
5:45PM	38	20	9	0	67	62	24	11	0	97	11	247	53	0	311	7	302	66	1	376	851
Hourly Total	258	100	34	0	392	283	133	57	0	473	44	1181	203	1	1429	20	1402	227	6	1655	3949
Total	1007	400	117	0	1524	940	481	210	0	1631	151	4733	969	4	5857	93	4503	1069	12	5677	14689
% Approach	66.1%	26.2%	7.7%	0%	-	57.6%	29.5%	12.9%	0%	-	2.6%	80.8%	16.5%	0.1%	-	1.6%	79.3%	18.8%	0.2%	-	-
% Total	6.9%	2.7%	0.8%	0%	10.4%	6.4%	3.3%	1.4%	0%	11.1%	1.0%	32.2%	6.6%	0%	39.9%	0.6%	30.7%	7.3%	0.1%	38.6%	-
Lights	990	377	112	0	1479	899	463	204	0	1566	147	4512	922	4	5585	86	4306	1053	12	5457	14087
% Lights	98.3%	94.3%	95.7%	0%	97.0%	95.6%	96.3%	97.1%	0%	96.0%	97.4%	95.3%	95.1%	100%	95.4%	92.5%	95.6%	98.5%	100%	96.1%	95.9%
Articulated Trucks	3	0	2	0	5	5	1	2	0	8	1	77	3	0	81	2	79	4	0	85	179
% Articulated Trucks	0.3%	0%	1.7%	0%	0.3%	0.5%	0.2%	1.0%	0%	0.5%	0.7%	1.6%	0.3%	0%	1.4%	2.2%	1.8%	0.4%	0%	1.5%	1.2%
Buses and Single-Unit Trucks	14	23	3	0	40	36	17	4	0	57	3	144	44	0	191	5	118	12	0	135	423
% Buses and Single-Unit Trucks	1.4%	5.8%	2.6%	0%	2.6%	3.8%	3.5%	1.9%	0%	3.5%	2.0%	3.0%	4.5%	0%	3.3%	5.4%	2.6%	1.1%	0%	2.4%	2.9%

*L: Left, R: Right, T: Thru, U: U-Turn

M-291 & Persels Rd - TMC

Thu Oct 20, 2022

Full Length (7 AM-9 AM, 4 PM-6 PM)

All Classes (Lights, Articulated Trucks, Buses and Single-Unit Trucks)

All Movements

ID: 1001816, Location: 38.89606, -94.375421



Provided by: Gewalt Hamilton Associates Inc.
625 Forest Edge Drive, Vernon Hills, IL, 60061, US

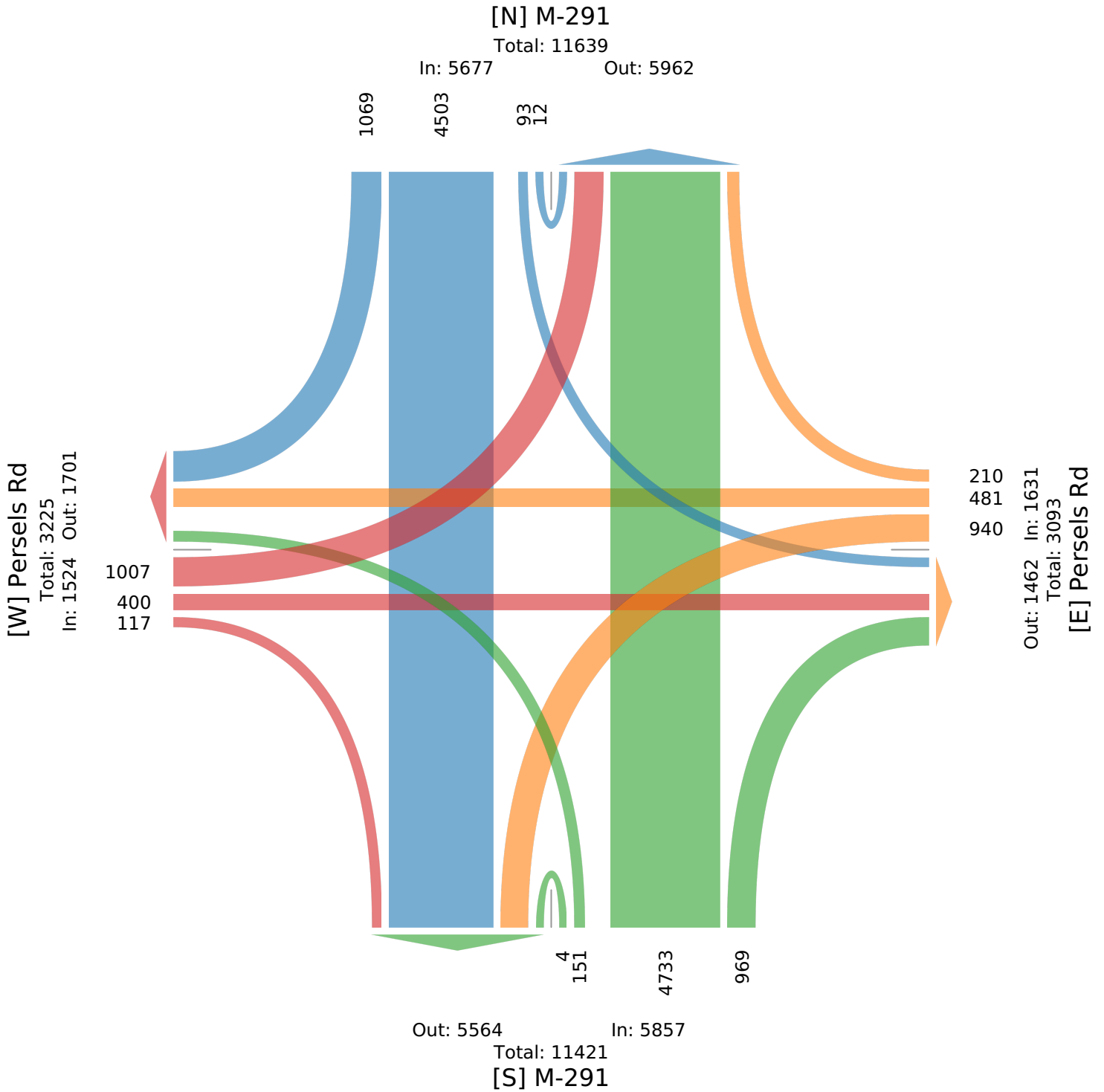

M-291 & Persels Rd - TMC

Thu Oct 20, 2022

AM Peak (7:15 AM - 8:15 AM)

All Classes (Lights, Articulated Trucks, Buses and Single-Unit Trucks)

All Movements

ID: 1001816, Location: 38.89606, -94.375421



Provided by: Gewalt Hamilton Associates Inc.

625 Forest Edge Drive, Vernon Hills, IL, 60061, US

Leg Direction	Persels Rd Eastbound					Persels Rd Westbound					M-291 Northbound					M-291 Southbound					Int
	L	T	R	U	App	L	T	R	U	App	L	T	R	U	App	L	T	R	U	App	
2022-10-20 7:15AM	72	17	3	0	92	44	30	12	0	86	13	319	53	0	385	4	210	100	1	315	878
7:30AM	63	34	4	0	101	36	25	10	0	71	9	391	83	0	483	3	238	85	0	326	981
7:45AM	46	19	6	0	71	51	34	8	0	93	14	301	74	1	390	13	234	80	1	328	882
8:00AM	65	21	11	0	97	43	36	10	0	89	6	332	58	1	397	5	209	101	1	316	899
Total	246	91	24	0	361	174	125	40	0	339	42	1343	268	2	1655	25	891	366	3	1285	3640
% Approach	68.1%	25.2%	6.6%	0%	-	51.3%	36.9%	11.8%	0%	-	2.5%	81.1%	16.2%	0.1%	-	1.9%	69.3%	28.5%	0.2%	-	-
% Total	6.8%	2.5%	0.7%	0%	9.9%	4.8%	3.4%	1.1%	0%	9.3%	1.2%	36.9%	7.4%	0.1%	45.5%	0.7%	24.5%	10.1%	0.1%	35.3%	-
PHF	0.854	0.669	0.545	-	0.894	0.853	0.868	0.833	-	0.911	0.750	0.859	0.807	0.500	0.857	0.481	0.936	0.906	0.750	0.979	0.928
Lights	241	90	23	0	354	161	120	38	0	319	42	1260	257	2	1561	24	826	360	3	1213	3447
% Lights	98.0%	98.9%	95.8%	0%	98.1%	92.5%	96.0%	95.0%	0%	94.1%	100%	93.8%	95.9%	100%	94.3%	96.0%	92.7%	98.4%	100%	94.4%	94.7%
Articulated Trucks	0	0	1	0	1	2	1	1	0	4	0	21	0	0	21	0	29	1	0	30	56
% Articulated Trucks	0%	0%	4.2%	0%	0.3%	1.1%	0.8%	2.5%	0%	1.2%	0%	1.6%	0%	0%	1.3%	0%	3.3%	0.3%	0%	2.3%	1.5%
Buses and Single-Unit Trucks	5	1	0	0	6	11	4	1	0	16	0	62	11	0	73	1	36	5	0	42	137
% Buses and Single-Unit Trucks	2.0%	1.1%	0%	0%	1.7%	6.3%	3.2%	2.5%	0%	4.7%	0%	4.6%	4.1%	0%	4.4%	4.0%	4.0%	1.4%	0%	3.3%	3.8%

* L: Left, R: Right, T: Thru, U: U-Turn

M-291 & Persels Rd - TMC
 Thu Oct 20, 2022
 AM Peak (7:15 AM - 8:15 AM)
 All Classes (Lights, Articulated Trucks, Buses and Single-Unit Trucks)
 All Movements
 ID: 1001816, Location: 38.89606, -94.375421

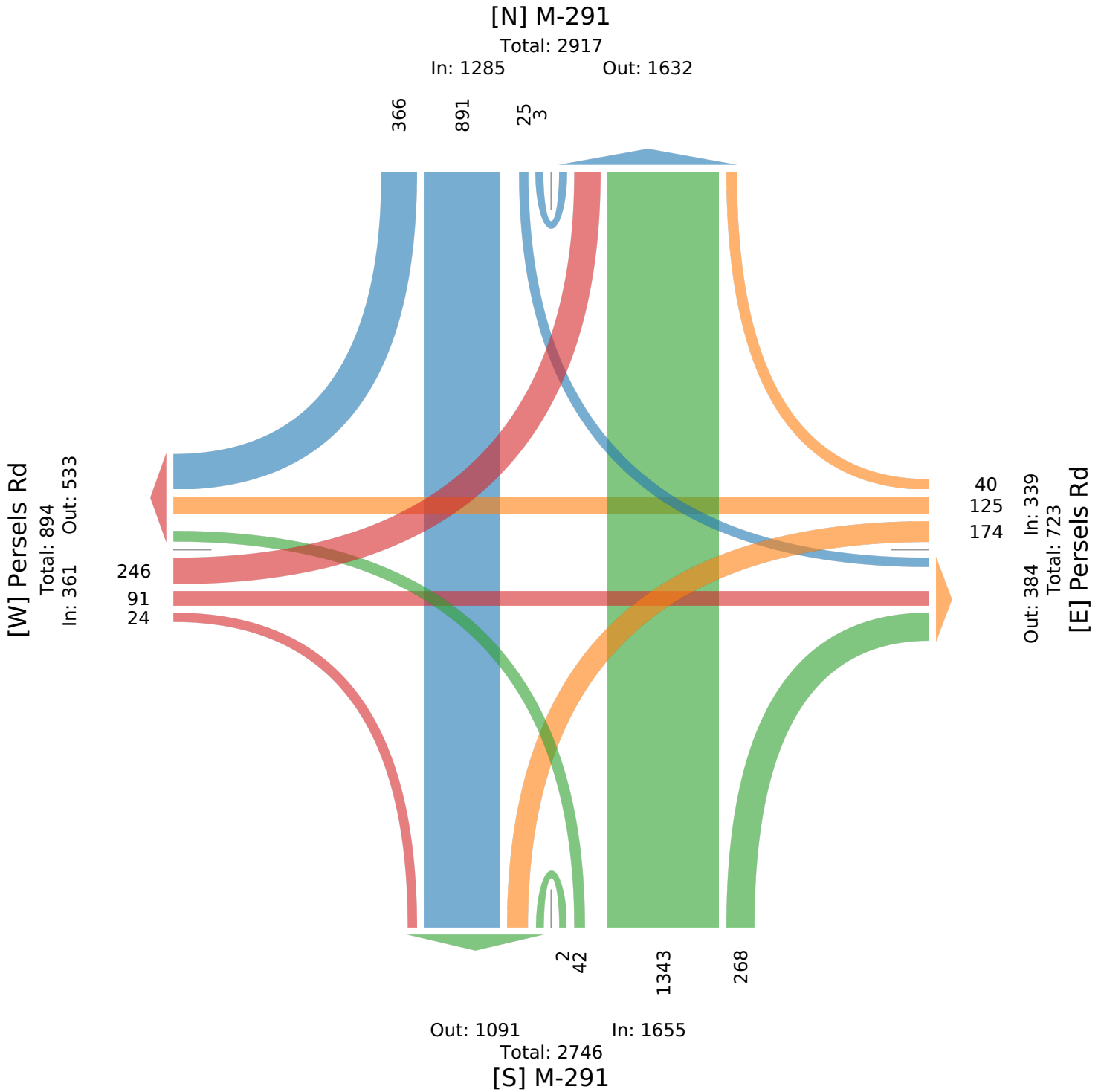

M-291 & Persels Rd - TMC

Thu Oct 20, 2022

PM Peak (4:15 PM - 5:15 PM) - Overall Peak Hour

All Classes (Lights, Articulated Trucks, Buses and Single-Unit Trucks)

All Movements

ID: 1001816, Location: 38.89606, -94.375421



Provided by: Gewalt Hamilton Associates Inc.

625 Forest Edge Drive, Vernon Hills, IL, 60061, US

Leg Direction	Persels Rd Eastbound					Persels Rd Westbound					M-291 Northbound					M-291 Southbound					Int
	L	T	R	U	App	L	T	R	U	App	L	T	R	U	App	L	T	R	U	App	
2022-10-20 4:15PM	68	29	5	0	102	85	38	17	0	140	12	267	61	0	340	7	312	90	0	409	991
4:30PM	76	33	11	0	120	87	32	21	0	140	12	321	76	0	409	12	443	73	1	529	1198
4:45PM	81	39	10	0	130	75	27	16	0	118	9	260	77	0	346	6	389	70	0	465	1059
5:00PM	86	30	9	0	125	81	42	22	0	145	11	313	54	0	378	4	418	68	1	491	1139
Total	311	131	35	0	477	328	139	76	0	543	44	1161	268	0	1473	29	1562	301	2	1894	4387
% Approach	65.2%	27.5%	7.3%	0%	-	60.4%	25.6%	14.0%	0%	-	3.0%	78.8%	18.2%	0%	-	1.5%	82.5%	15.9%	0.1%	-	-
% Total	7.1%	3.0%	0.8%	0%	10.9%	7.5%	3.2%	1.7%	0%	12.4%	1.0%	26.5%	6.1%	0%	33.6%	0.7%	35.6%	6.9%	0%	43.2%	-
PHF	0.904	0.840	0.795	-	0.917	0.943	0.827	0.864	-	0.936	0.917	0.904	0.870	-	0.900	0.604	0.881	0.836	0.500	0.895	0.915
Lights	309	117	32	0	458	322	137	75	0	534	43	1128	246	0	1417	26	1531	297	2	1856	4265
% Lights	99.4%	89.3%	91.4%	0%	96.0%	98.2%	98.6%	98.7%	0%	98.3%	97.7%	97.2%	91.8%	0%	96.2%	89.7%	98.0%	98.7%	100%	98.0%	97.2%
Articulated Trucks	0	0	1	0	1	2	0	0	0	2	1	12	0	0	13	0	13	2	0	15	31
% Articulated Trucks	0%	0%	2.9%	0%	0.2%	0.6%	0%	0%	0%	0.4%	2.3%	1.0%	0%	0%	0.9%	0%	0.8%	0.7%	0%	0.8%	0.7%
Buses and Single-Unit Trucks	2	14	2	0	18	4	2	1	0	7	0	21	22	0	43	3	18	2	0	23	91
% Buses and Single-Unit Trucks	0.6%	10.7%	5.7%	0%	3.8%	1.2%	1.4%	1.3%	0%	1.3%	0%	1.8%	8.2%	0%	2.9%	10.3%	1.2%	0.7%	0%	1.2%	2.1%

* L: Left, R: Right, T: Thru, U: U-Turn

M-291 & Persels Rd - TMC

Thu Oct 20, 2022

PM Peak (4:15 PM - 5:15 PM) - Overall Peak Hour

All Classes (Lights, Articulated Trucks, Buses and Single-Unit Trucks)

All Movements

ID: 1001816, Location: 38.89606, -94.375421



Provided by: Gewalt Hamilton Associates Inc.
625 Forest Edge Drive, Vernon Hills, IL, 60061, US

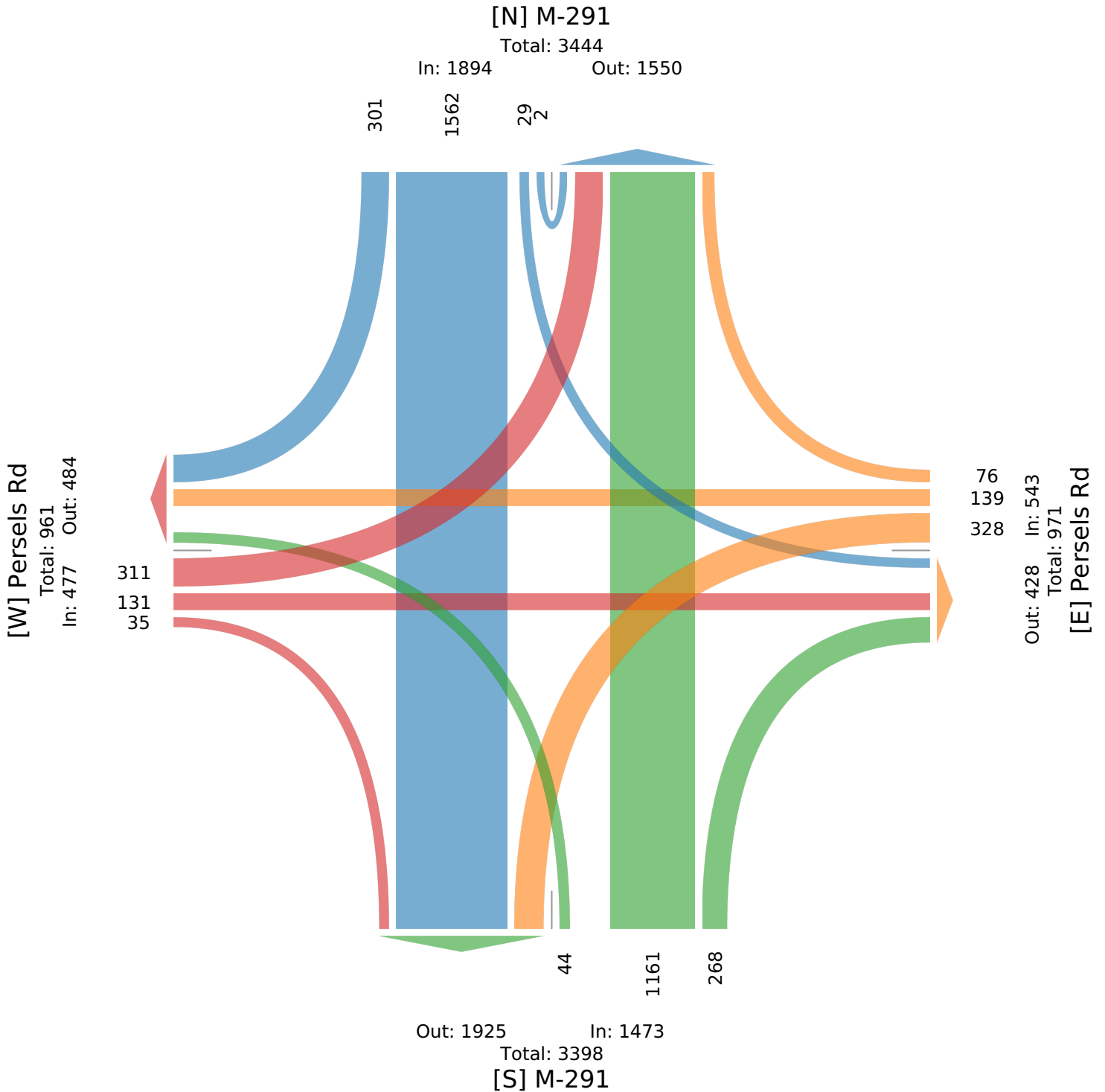

M-291 & Persels Rd - TMC

Sat Oct 22, 2022

Full Length (12 PM-2 PM)

All Classes (Lights, Articulated Trucks, Buses and Single-Unit Trucks)

All Movements

ID: 1001812, Location: 38.89606, -94.375421



Provided by: Gewalt Hamilton Associates Inc.
625 Forest Edge Drive, Vernon Hills, IL, 60061, US

Leg Direction	Persels Rd Eastbound					Persels Rd Westbound					M-291 Northbound					M-291 Southbound					
Time	L	T	R	U	App	L	T	R	U	App	L	T	R	U	App	L	T	R	U	App	Int
2022-10-22 12:00PM	41	29	8	0	78	39	15	8	0	62	2	227	28	4	261	2	218	40	4	264	665
12:15PM	28	19	6	0	53	27	15	6	0	48	4	249	31	2	286	4	238	45	2	289	676
12:30PM	29	24	15	0	68	26	19	15	0	60	1	235	38	1	275	1	221	41	1	264	667
12:45PM	21	20	9	0	50	20	17	9	0	46	10	238	35	0	283	10	228	52	0	290	669
Hourly Total	119	92	38	0	249	112	66	38	0	216	17	949	132	7	1105	17	905	178	7	1107	2677
1:00PM	32	18	11	0	61	31	16	11	0	58	6	218	22	1	247	6	216	42	1	265	631
1:15PM	33	17	6	0	56	31	13	6	0	50	3	219	21	1	244	3	218	47	1	269	619
1:30PM	27	13	6	0	46	28	21	6	0	55	7	239	21	1	268	7	237	22	1	267	636
1:45PM	42	19	4	0	65	42	17	4	0	63	4	190	38	1	233	4	187	43	1	235	596
Hourly Total	134	67	27	0	228	132	67	27	0	226	20	866	102	4	992	20	858	154	4	1036	2482
Total	253	159	65	0	477	244	133	65	0	442	37	1815	234	11	2097	37	1763	332	11	2143	5159
% Approach	53.0%	33.3%	13.6%	0%	-	55.2%	30.1%	14.7%	0%	-	1.8%	86.6%	11.2%	0.5%	-	1.7%	82.3%	15.5%	0.5%	-	-
% Total	4.9%	3.1%	1.3%	0%	9.2%	4.7%	2.6%	1.3%	0%	8.6%	0.7%	35.2%	4.5%	0.2%	40.6%	0.7%	34.2%	6.4%	0.2%	41.5%	-
Lights	252	158	63	0	473	243	132	63	0	438	37	1784	230	11	2062	37	1738	327	11	2113	5086
% Lights	99.6%	99.4%	96.9%	0%	99.2%	99.6%	99.2%	96.9%	0%	99.1%	100%	98.3%	98.3%	100%	98.3%	100%	98.6%	98.5%	100%	98.6%	98.6%
Articulated Trucks	0	0	1	0	1	0	0	1	0	1	0	8	0	0	8	0	7	2	0	9	19
% Articulated Trucks	0%	0%	1.5%	0%	0.2%	0%	0%	1.5%	0%	0.2%	0%	0.4%	0%	0%	0.4%	0%	0.4%	0.6%	0%	0.4%	0.4%
Buses and Single-Unit Trucks	1	1	1	0	3	1	1	1	0	3	0	23	4	0	27	0	18	3	0	21	54
% Buses and Single-Unit Trucks	0.4%	0.6%	1.5%	0%	0.6%	0.4%	0.8%	1.5%	0%	0.7%	0%	1.3%	1.7%	0%	1.3%	0%	1.0%	0.9%	0%	1.0%	1.0%

*L: Left, R: Right, T: Thru, U: U-Turn

M-291 & Persels Rd - TMC

Sat Oct 22, 2022

Full Length (12 PM-2 PM)

All Classes (Lights, Articulated Trucks, Buses and Single-Unit Trucks)

All Movements

ID: 1001812, Location: 38.89606, -94.375421



Provided by: Gewalt Hamilton Associates Inc.
625 Forest Edge Drive, Vernon Hills, IL, 60061, US

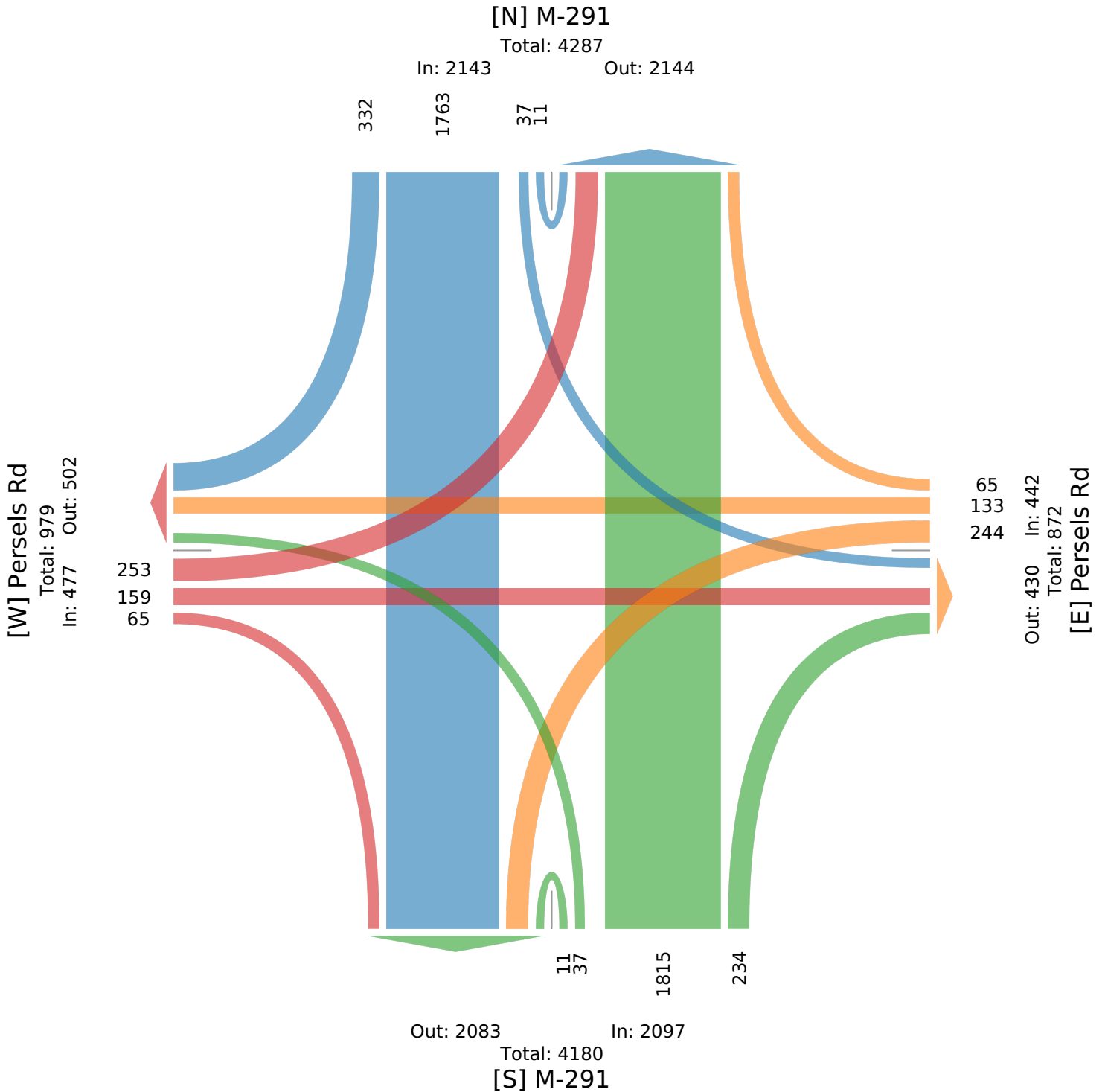

M-291 & Persels Rd - TMC

Sat Oct 22, 2022

Midday Peak (WKND) (12 PM - 1 PM) - Overall Peak Hour

All Classes (Lights, Articulated Trucks, Buses and Single-Unit Trucks)

All Movements

ID: 1001812, Location: 38.89606, -94.375421



Provided by: Gewalt Hamilton Associates Inc.

625 Forest Edge Drive, Vernon Hills, IL, 60061, US

Leg Direction	Persels Rd Eastbound					Persels Rd Westbound					M-291 Northbound					M-291 Southbound					Int
	L	T	R	U	App	L	T	R	U	App	L	T	R	U	App	L	T	R	U	App	
2022-10-22 12:00PM	41	29	8	0	78	39	15	8	0	62	2	227	28	4	261	2	218	40	4	264	665
12:15PM	28	19	6	0	53	27	15	6	0	48	4	249	31	2	286	4	238	45	2	289	676
12:30PM	29	24	15	0	68	26	19	15	0	60	1	235	38	1	275	1	221	41	1	264	667
12:45PM	21	20	9	0	50	20	17	9	0	46	10	238	35	0	283	10	228	52	0	290	669
Total	119	92	38	0	249	112	66	38	0	216	17	949	132	7	1105	17	905	178	7	1107	2677
% Approach	47.8%	36.9%	15.3%	0%	-	51.9%	30.6%	17.6%	0%	-	1.5%	85.9%	11.9%	0.6%	-	1.5%	81.8%	16.1%	0.6%	-	-
% Total	4.4%	3.4%	1.4%	0%	9.3%	4.2%	2.5%	1.4%	0%	8.1%	0.6%	35.5%	4.9%	0.3%	41.3%	0.6%	33.8%	6.6%	0.3%	41.4%	-
PHF	0.726	0.793	0.633	-	0.798	0.718	0.868	0.633	-	0.871	0.425	0.953	0.868	0.438	0.966	0.425	0.951	0.856	0.438	0.954	0.990
Lights	118	92	36	0	246	111	65	36	0	212	17	928	131	7	1083	17	890	176	7	1090	2631
% Lights	99.2%	100%	94.7%	0%	98.8%	99.1%	98.5%	94.7%	0%	98.1%	100%	97.8%	99.2%	100%	98.0%	100%	98.3%	98.9%	100%	98.5%	98.3%
Articulated Trucks	0	0	1	0	1	0	0	1	0	1	0	6	0	0	6	0	5	1	0	6	14
% Articulated Trucks	0%	0%	2.6%	0%	0.4%	0%	0%	2.6%	0%	0.5%	0%	0.6%	0%	0%	0.5%	0%	0.6%	0.6%	0%	0.5%	0.5%
Buses and Single-Unit Trucks	1	0	1	0	2	1	1	1	0	3	0	15	1	0	16	0	10	1	0	11	32
% Buses and Single-Unit Trucks	0.8%	0%	2.6%	0%	0.8%	0.9%	1.5%	2.6%	0%	1.4%	0%	1.6%	0.8%	0%	1.4%	0%	1.1%	0.6%	0%	1.0%	1.2%

*L: Left, R: Right, T: Thru, U: U-Turn

M-291 & Persels Rd - TMC

Sat Oct 22, 2022

Midday Peak (WKND) (12 PM - 1 PM) - Overall Peak Hour

All Classes (Lights, Articulated Trucks, Buses and Single-Unit Trucks)

All Movements

ID: 1001812, Location: 38.89606, -94.375421



Provided by: Gewalt Hamilton Associates Inc.
625 Forest Edge Drive, Vernon Hills, IL, 60061, US

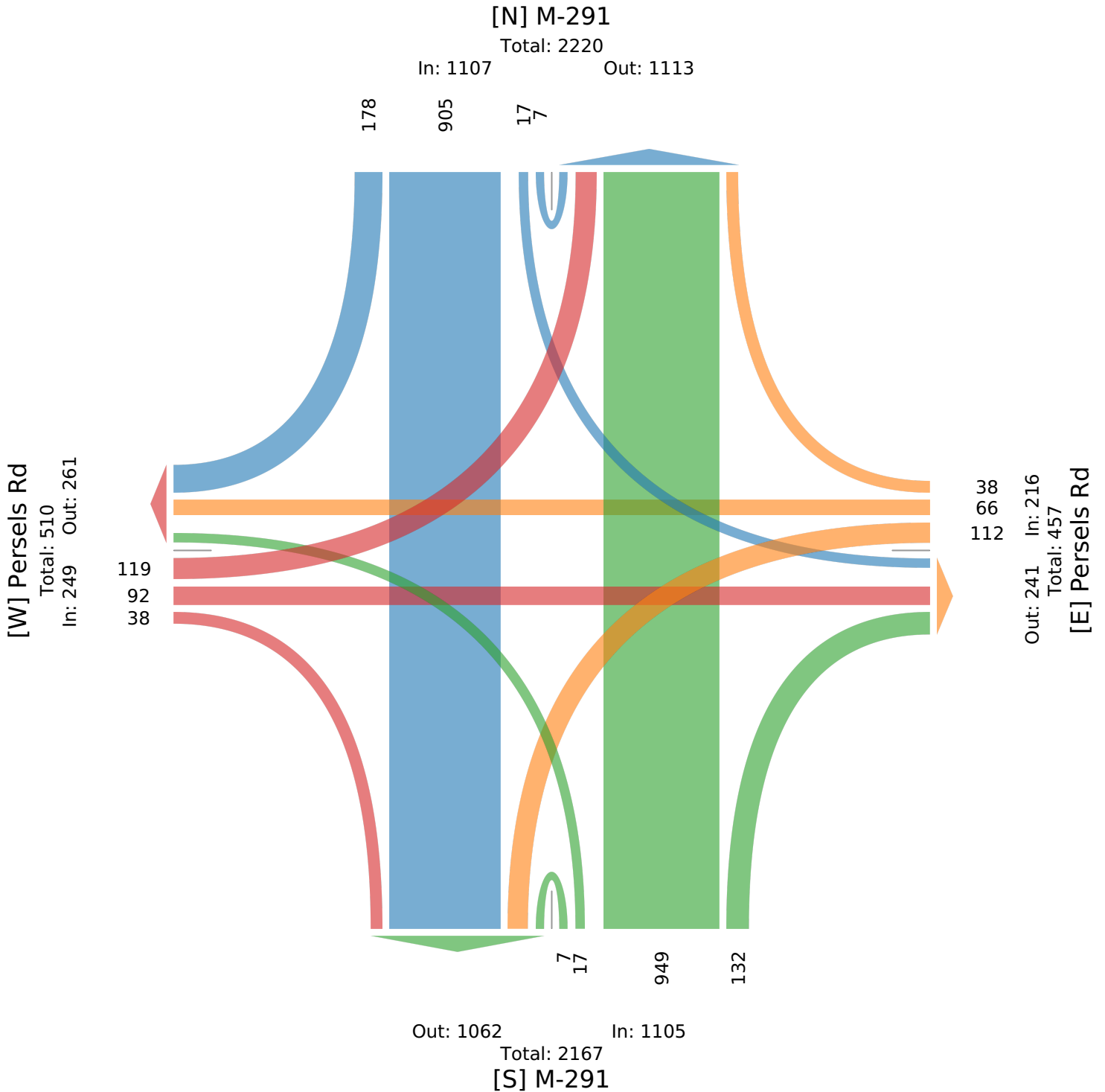

M-291 & Persels Rd - TMC

Sat Oct 22, 2022

PM Peak (WKND) (1 PM - 2 PM)

All Classes (Lights, Articulated Trucks, Buses and Single-Unit Trucks)

All Movements

ID: 1001812, Location: 38.89606, -94.375421



Provided by: Gewalt Hamilton Associates Inc.
625 Forest Edge Drive, Vernon Hills, IL, 60061, US

Leg Direction	Persels Rd Eastbound					Persels Rd Westbound					M-291 Northbound					M-291 Southbound					
Time	L	T	R	U	App	L	T	R	U	App	L	T	R	U	App	L	T	R	U	App	Int
2022-10-22 1:00PM	32	18	11	0	61	31	16	11	0	58	6	218	22	1	247	6	216	42	1	265	631
1:15PM	33	17	6	0	56	31	13	6	0	50	3	219	21	1	244	3	218	47	1	269	619
1:30PM	27	13	6	0	46	28	21	6	0	55	7	239	21	1	268	7	237	22	1	267	636
1:45PM	42	19	4	0	65	42	17	4	0	63	4	190	38	1	233	4	187	43	1	235	596
Total	134	67	27	0	228	132	67	27	0	226	20	866	102	4	992	20	858	154	4	1036	2482
% Approach	58.8%	29.4%	11.8%	0%	-	58.4%	29.6%	11.9%	0%	-	2.0%	87.3%	10.3%	0.4%	-	1.9%	82.8%	14.9%	0.4%	-	-
% Total	5.4%	2.7%	1.1%	0%	9.2%	5.3%	2.7%	1.1%	0%	9.1%	0.8%	34.9%	4.1%	0.2%	40.0%	0.8%	34.6%	6.2%	0.2%	41.7%	-
PHF	0.798	0.882	0.614	-	0.877	0.786	0.798	0.614	-	0.897	0.714	0.906	0.671	1.000	0.925	0.714	0.905	0.819	1.000	0.963	0.976
Lights	134	66	27	0	227	132	67	27	0	226	20	856	99	4	979	20	848	151	4	1023	2455
% Lights	100%	98.5%	100%	0%	99.6%	100%	100%	100%	0%	100%	100%	98.8%	97.1%	100%	98.7%	100%	98.8%	98.1%	100%	98.7%	98.9%
Articulated Trucks	0	0	0	0	0	0	0	0	0	0	0	2	0	0	2	0	2	1	0	3	5
% Articulated Trucks	0%	0%	0%	0%	0%	0%	0%	0%	0%	0%	0%	0.2%	0%	0%	0.2%	0%	0.2%	0.6%	0%	0.3%	0.2%
Buses and Single-Unit Trucks	0	1	0	0	1	0	0	0	0	0	0	8	3	0	11	0	8	2	0	10	22
% Buses and Single-Unit Trucks	0%	1.5%	0%	0%	0.4%	0%	0%	0%	0%	0%	0%	0.9%	2.9%	0%	1.1%	0%	0.9%	1.3%	0%	1.0%	0.9%

*L: Left, R: Right, T: Thru, U: U-Turn

M-291 & Persels Rd - TMC

Sat Oct 22, 2022

PM Peak (WKND) (1 PM - 2 PM)

All Classes (Lights, Articulated Trucks, Buses and Single-Unit Trucks)

All Movements

ID: 1001812, Location: 38.89606, -94.375421



Provided by: Gewalt Hamilton Associates Inc.
625 Forest Edge Drive, Vernon Hills, IL, 60061, US

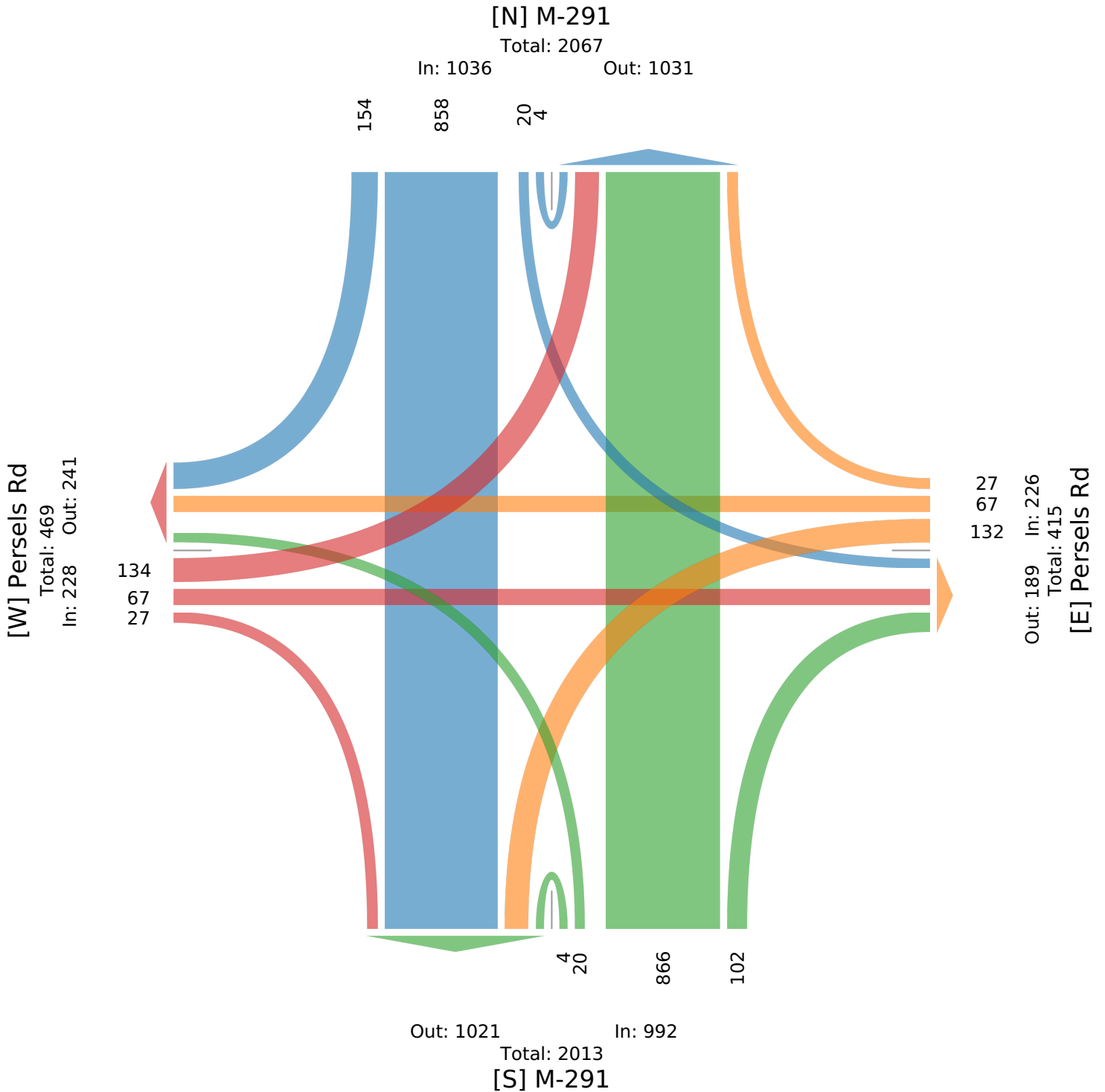

Appendix C: Site Plan

Lot Number	Lot Area (Sq. Ft.)	Building Area	Parking	Ratio
1	209649.79	0	536	0
2	370916.90	120000	505	4.2
3	67271.42	5500	100	18.1
4	116312.91	9686	165	17
5	110033.60	8000	141	17.6
5-A	19459.32	0	26	0
6	43311.53	2850	40	14
7	44532.00	2850	20	21.5
8	73114.12	5355	19	4.8
9	53805.91	3900	14	4.8
10	50513.21	4550	54	11.8
11	399182.25	80895	469	5.7
12	53987.80	2500	35	14
13	65150.44	9300	50	5.3
14	43517.73	2571	38	14.7
15	34649.16	973	8	8.2
16	54371.71	2600	40	15.3
17	50472.15	2850	40	14
18	96832.50	4500	46	10.2
TRACT A	98865.19	0	0	0

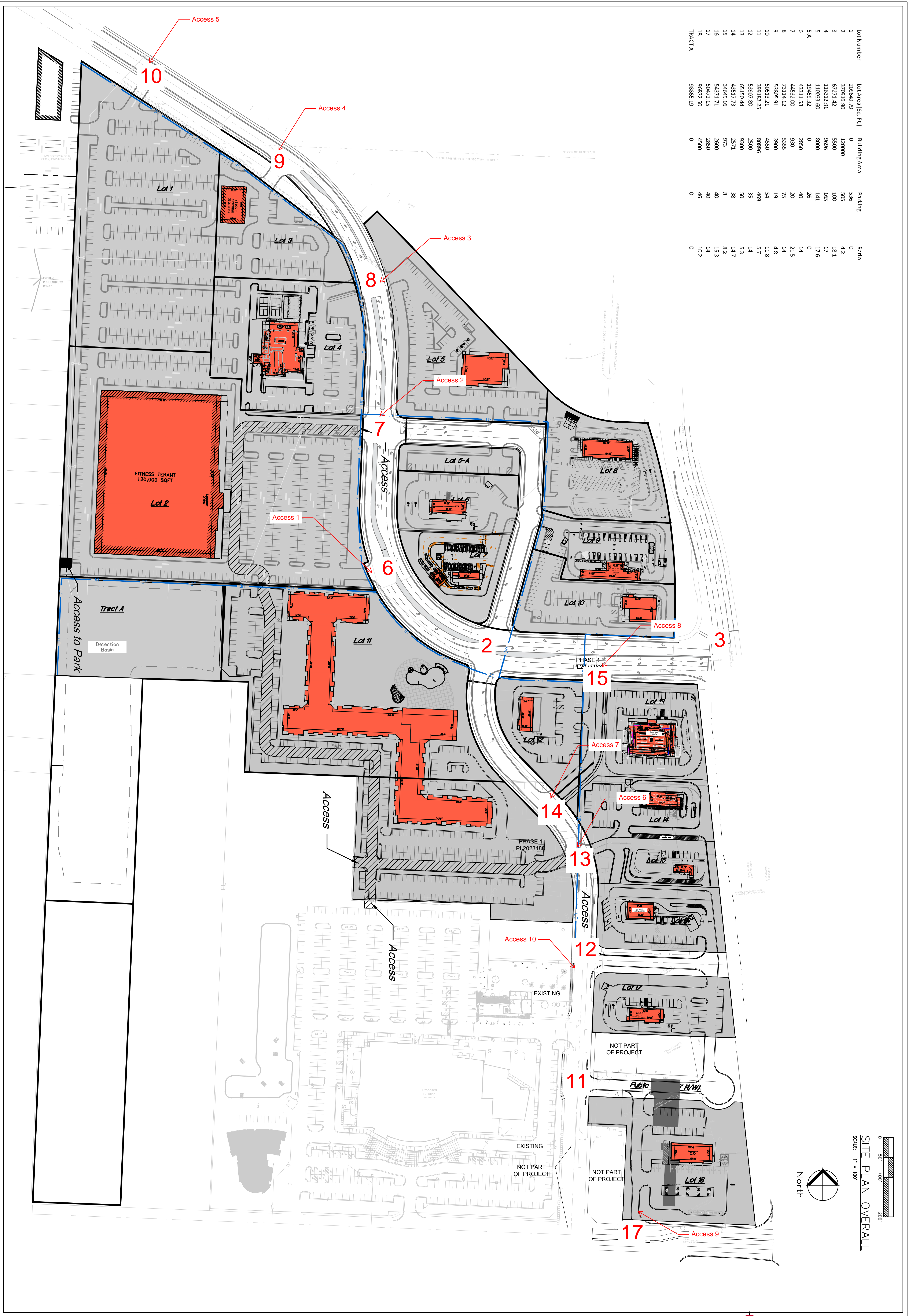

SITE PLAN OVERALL
SCALE: 1" = 100'

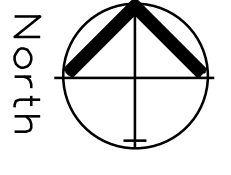

ENGINEERING SOLUTIONS
ENGINEERING & SURVEYING
50 SE 30TH STREET
LEE'S SUMMIT, MO 64082
P:(816) 623-9888 F:(816)623-9849

Oldham Village
LEE'S SUMMIT, JACKSON COUNTY, MISSOURI

Project:
OLDHAM VILLAGE
Issue Date:
June 10, 2024

SITE PLAN OVERALL
Phase 2 Preliminary Development Plans for:
Oldham Village
LEE'S SUMMIT, JACKSON COUNTY, MISSOURI



Matthew J. Schlicht
NO. PE 2006019708
C.S. PE 15978
REVISIONS
REV. 7/9/2024
REV. 6/25/2024
REV. 8/7/2024

C.100

Appendix D: ITE Trip Generation Manual Data

Phase 1

Land Use: 495

Recreational Community Center

Description

A recreational community center is a stand-alone public facility similar to and including YMCAs. These facilities often include classes and clubs for adults and children, a day care or nursery school, meeting rooms and other social facilities, swimming pools and whirlpools, saunas, tennis, racquetball, handball, pickle ball, basketball and volleyball courts; outdoor athletic fields/courts, exercise classes, weightlifting and gymnastics equipment, locker rooms, and a restaurant or snack bar. Public access is typically allowed and a membership fee may be charged. Racquet/tennis club (Land Use 491), health/fitness club (Land Use 492), and athletic club (Land Use 493) are related land uses.

Additional Data

The technical appendices provide supporting information on time-of-day distributions for this land use. The appendices can be accessed through either the ITETripGen web app or the trip generation resource page on the ITE website (<https://www.ite.org/technical-resources/topics/trip-and-parking-generation/>).

The sites were surveyed in the 1980s, the 1990s, the 2000s, the 2010s, and the 2020s in Alberta (CAN), Arizona, Indiana, Minnesota, New Hampshire, New York, Oregon, Pennsylvania, Tennessee, and Utah.

Source Numbers

281, 410, 443, 571, 618, 705, 719, 850, 866, 971, 1055

Recreational Community Center (495)

Vehicle Trip Ends vs: 1000 Sq. Ft. GFA
On a: Weekday

Setting/Location: General Urban/Suburban
Number of Studies: 4
Avg. 1000 Sq. Ft. GFA: 78
Directional Distribution: 50% entering, 50% exiting

Vehicle Trip Generation per 1000 Sq. Ft. GFA

Average Rate	Range of Rates	Standard Deviation
28.82	21.49 - 36.71	8.56

Data Plot and Equation

Caution – Small Sample Size

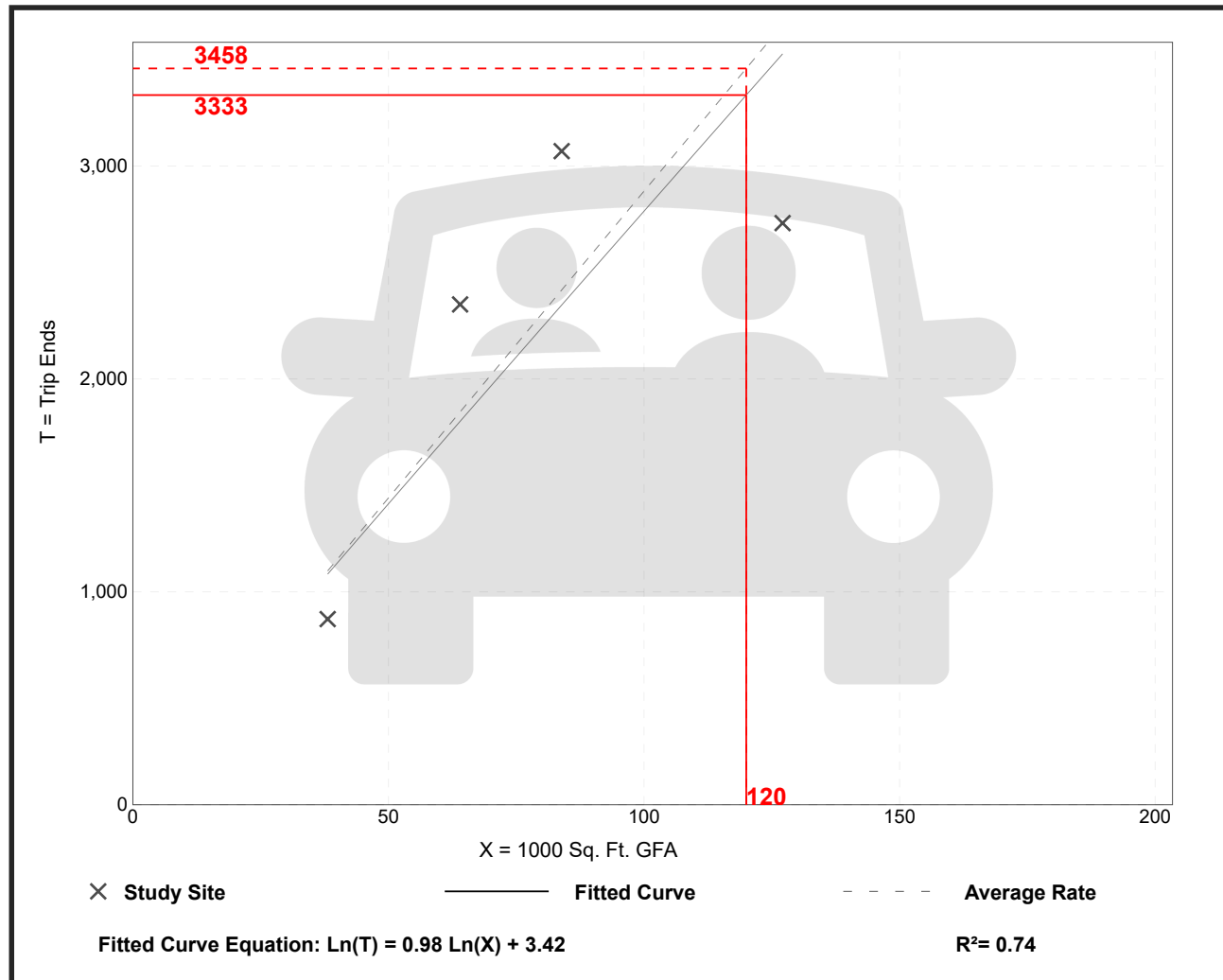

Recreational Community Center (495)

Vehicle Trip Ends vs: 1000 Sq. Ft. GFA
On a: Weekday,
Peak Hour of Adjacent Street Traffic,
One Hour Between 7 and 9 a.m.
Setting/Location: General Urban/Suburban
 Number of Studies: 12
 Avg. 1000 Sq. Ft. GFA: 105
 Directional Distribution: 66% entering, 34% exiting

Vehicle Trip Generation per 1000 Sq. Ft. GFA

Average Rate	Range of Rates	Standard Deviation
1.91	1.08 - 4.18	0.88

Data Plot and Equation

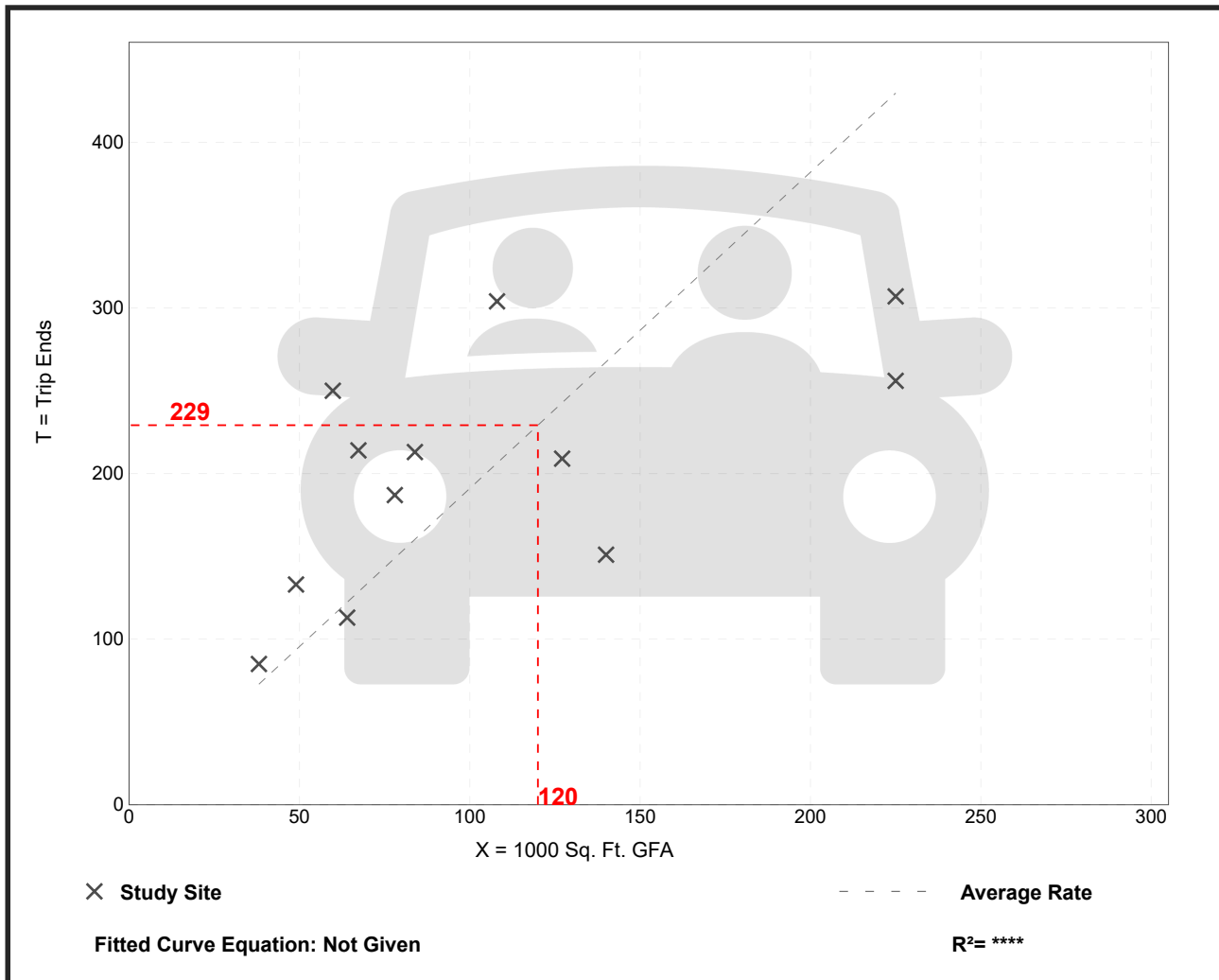

Recreational Community Center (495)

Vehicle Trip Ends vs: 1000 Sq. Ft. GFA
On a: Weekday,
Peak Hour of Adjacent Street Traffic,
One Hour Between 4 and 6 p.m.
Setting/Location: General Urban/Suburban
 Number of Studies: 15
 Avg. 1000 Sq. Ft. GFA: 124
 Directional Distribution: 47% entering, 53% exiting

Vehicle Trip Generation per 1000 Sq. Ft. GFA

Average Rate	Range of Rates	Standard Deviation
2.50	1.05 - 5.37	1.28

Data Plot and Equation

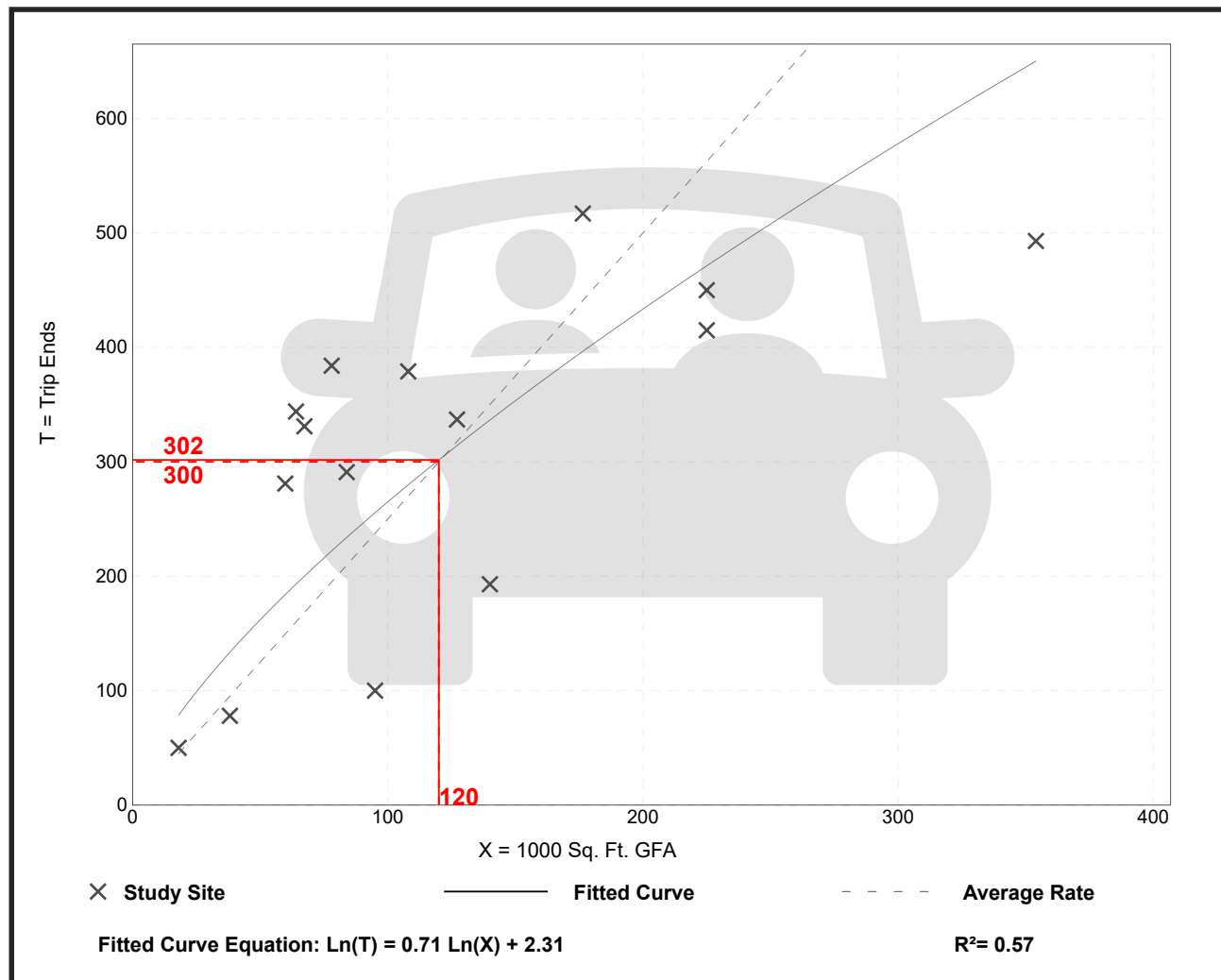

Recreational Community Center (495)

Vehicle Trip Ends vs: 1000 Sq. Ft. GFA
On a: Saturday, Peak Hour of Generator

Setting/Location: General Urban/Suburban
Number of Studies: 4
Avg. 1000 Sq. Ft. GFA: 81
Directional Distribution: 54% entering, 46% exiting

Vehicle Trip Generation per 1000 Sq. Ft. GFA

Average Rate	Range of Rates	Standard Deviation
1.07	0.58 - 2.18	0.56

Data Plot and Equation

Caution – Small Sample Size

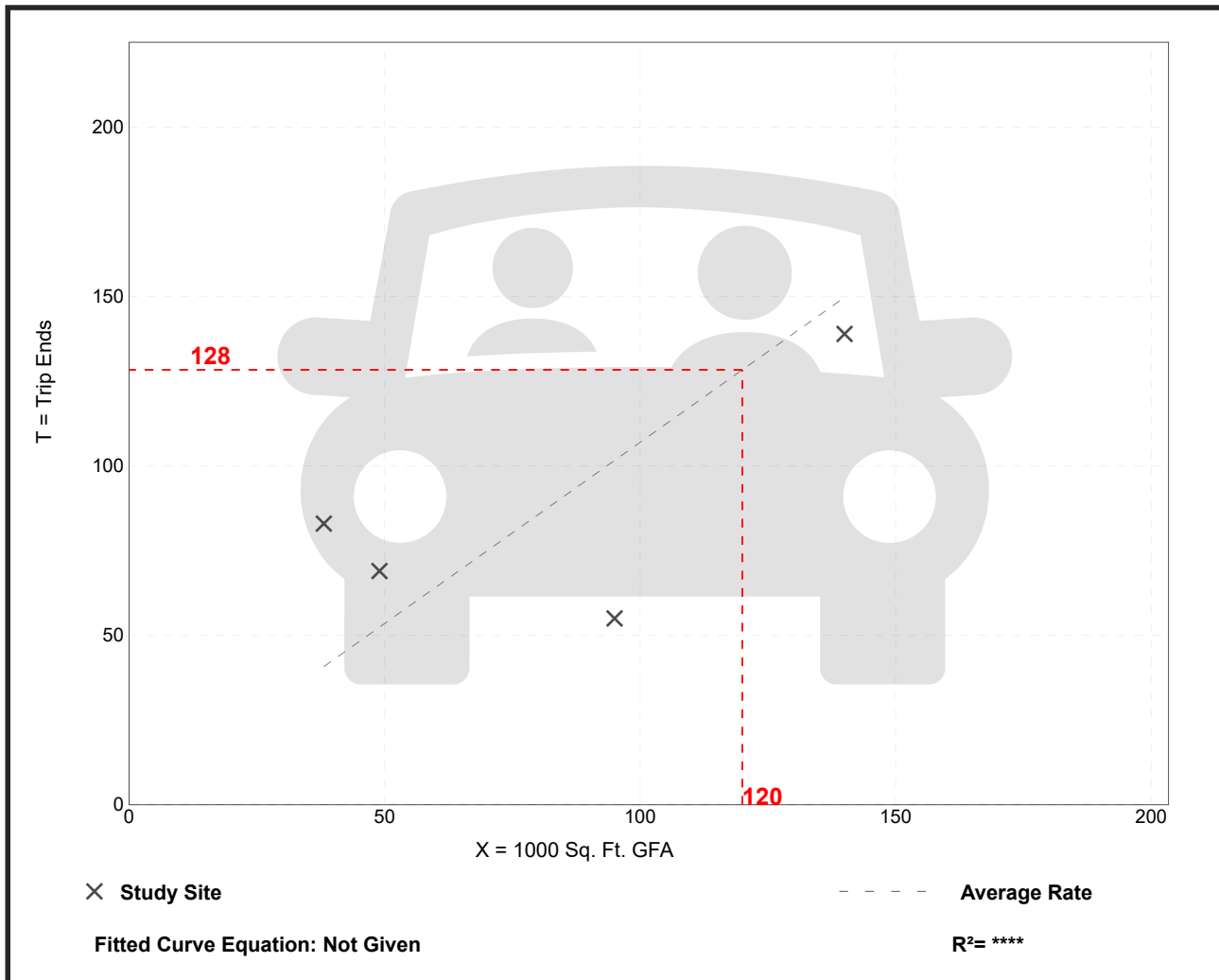

Land Use: 822

Strip Retail Plaza (<40k)

Description

A strip retail plaza is an integrated group of commercial establishments that is planned, developed, owned, and managed as a unit. Each study site in this land use has less than 40,000 square feet of gross leasable area (GLA). Because a strip retail plaza is open-air, the GLA is the same as the gross floor area of the building.

The 40,000 square feet GFA threshold between strip retail plaza and shopping plaza (Land Use 821) was selected based on an examination of the overall shopping center/plaza database. No shopping plaza with a supermarket as its anchor is smaller than 40,000 square feet GLA.

Shopping center (>150k) (Land use 820), shopping plaza (40-150k) (Land Use 821), and factory outlet center (Land Use 823) are related uses.

Additional Data

The technical appendices provide supporting information on time-of-day distributions for this land use. The appendices can be accessed through either the ITETripGen web app or the trip generation resource page on the ITE website (<https://www.ite.org/technical-resources/topics/trip-and-parking-generation/>).

The sites were surveyed in the 1980s, the 1990s, the 2000s, and the 2010s in Alberta (CAN), California, Delaware, Florida, New Jersey, Ontario (CAN), South Dakota, Vermont, Washington, and Wisconsin.

Source Numbers

304, 358, 423, 428, 437, 507, 715, 728, 936, 960, 961, 974, 1009

Strip Retail Plaza (<40k) (822)

Vehicle Trip Ends vs: 1000 Sq. Ft. GLA
On a: Weekday

Setting/Location: General Urban/Suburban
Number of Studies: 4
Avg. 1000 Sq. Ft. GLA: 19
Directional Distribution: 50% entering, 50% exiting

Vehicle Trip Generation per 1000 Sq. Ft. GLA

Average Rate	Range of Rates	Standard Deviation
54.45	47.86 - 65.07	7.81

Data Plot and Equation

Caution – Small Sample Size

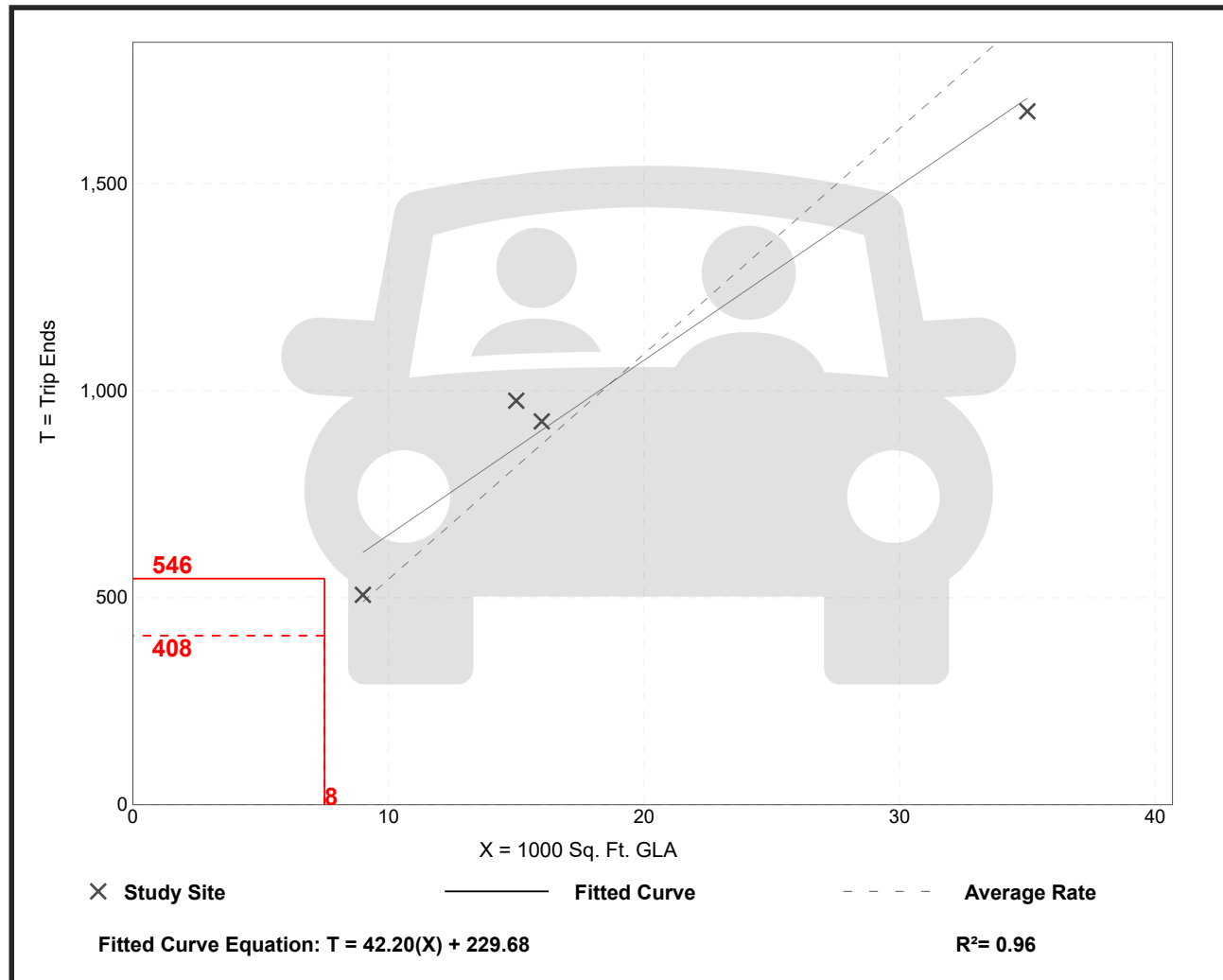

Strip Retail Plaza (<40k) (822)

Vehicle Trip Ends vs: 1000 Sq. Ft. GLA
On a: Weekday,
Peak Hour of Adjacent Street Traffic,
One Hour Between 7 and 9 a.m.
Setting/Location: General Urban/Suburban
 Number of Studies: 5
 Avg. 1000 Sq. Ft. GLA: 18
 Directional Distribution: 60% entering, 40% exiting

Vehicle Trip Generation per 1000 Sq. Ft. GLA

Average Rate	Range of Rates	Standard Deviation
2.36	1.60 - 3.73	0.94

Data Plot and Equation

Caution – Small Sample Size

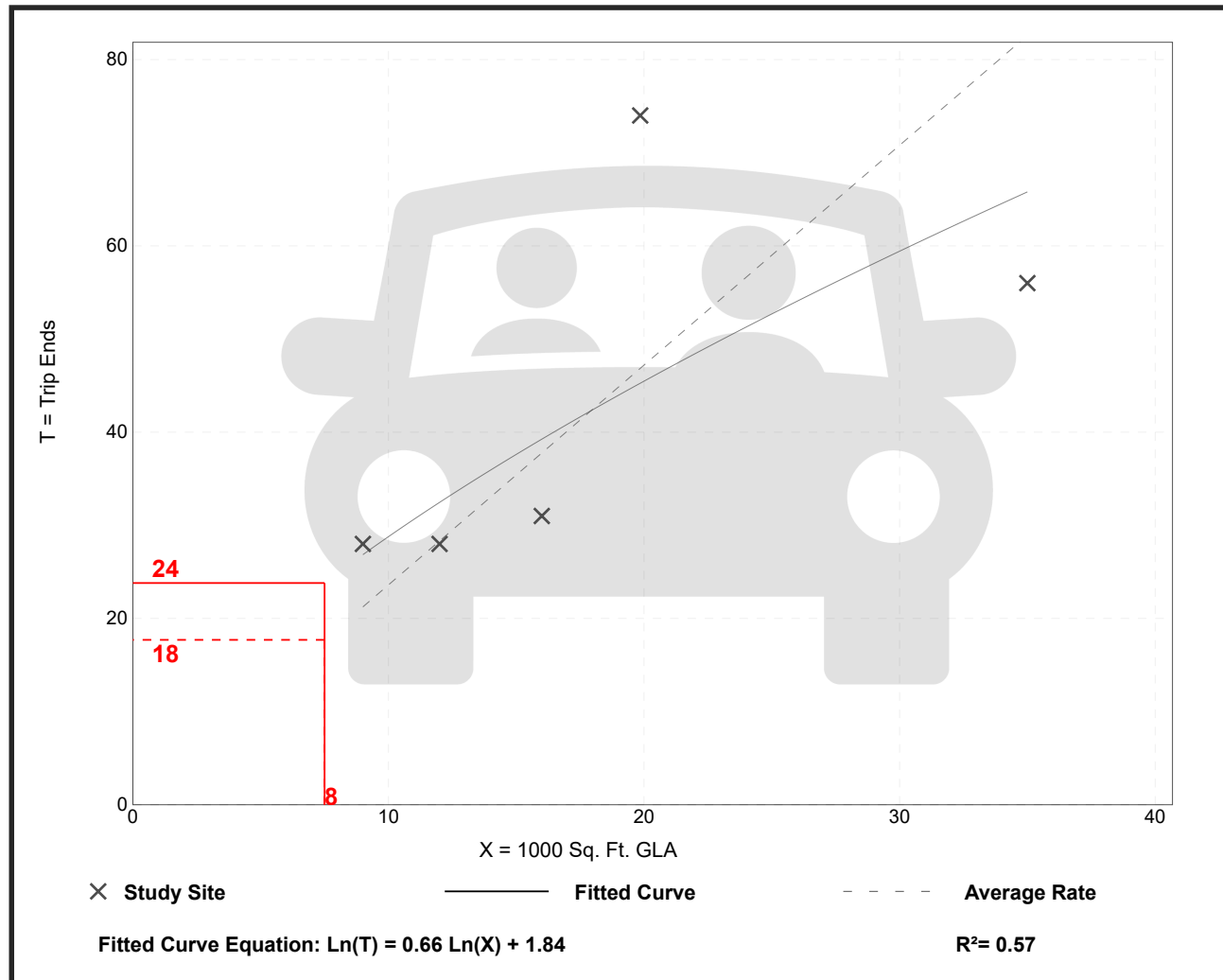

Strip Retail Plaza (<40k) (822)

Vehicle Trip Ends vs: 1000 Sq. Ft. GLA
On a: Weekday,
Peak Hour of Adjacent Street Traffic,
One Hour Between 4 and 6 p.m.
Setting/Location: General Urban/Suburban
 Number of Studies: 25
 Avg. 1000 Sq. Ft. GLA: 21
 Directional Distribution: 50% entering, 50% exiting

Vehicle Trip Generation per 1000 Sq. Ft. GLA

Average Rate	Range of Rates	Standard Deviation
6.59	2.81 - 15.20	2.94

Data Plot and Equation

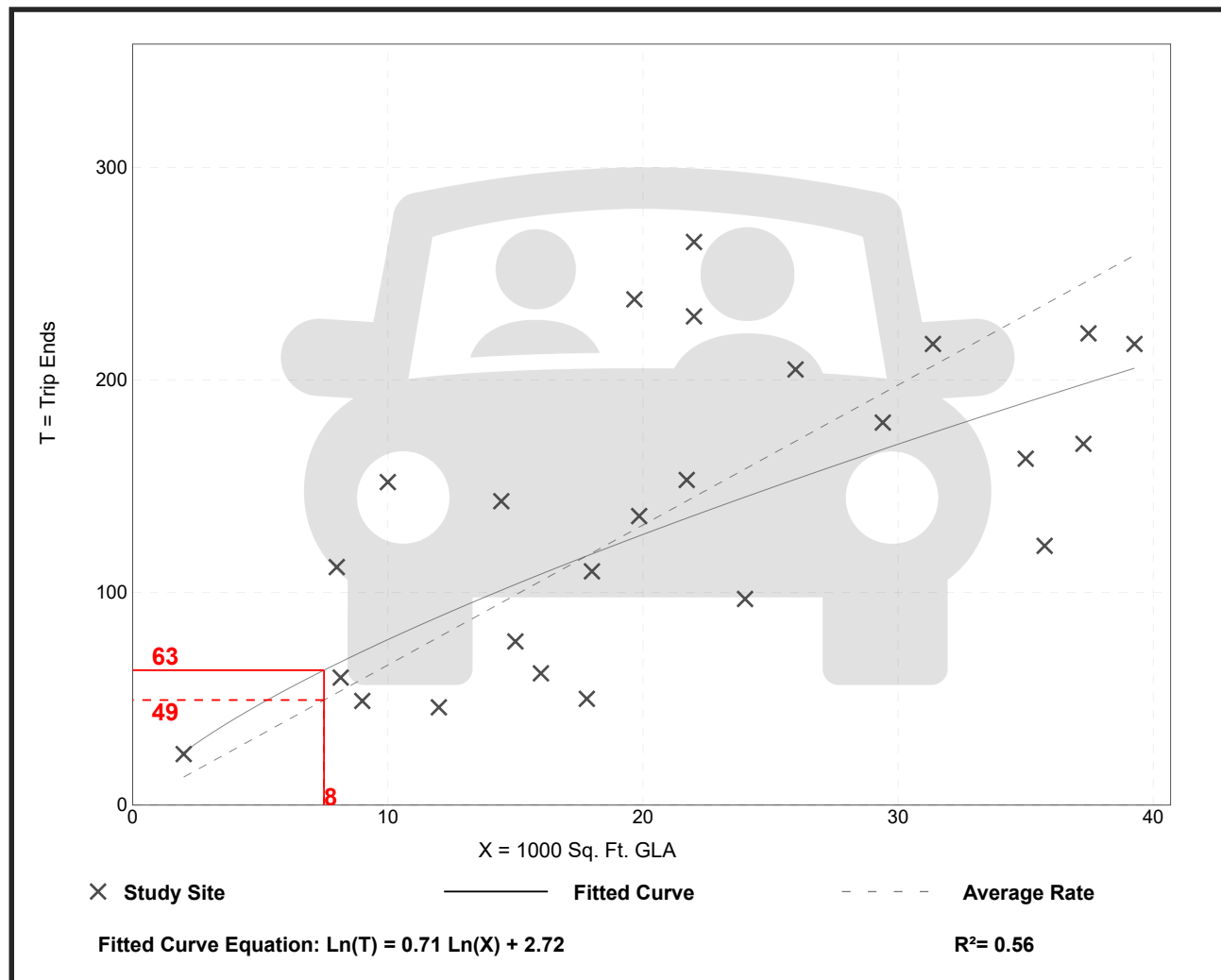

Strip Retail Plaza (<40k) (822)

Vehicle Trip Ends vs: 1000 Sq. Ft. GLA
On a: Saturday, Peak Hour of Generator

Setting/Location: General Urban/Suburban
Number of Studies: 12
Avg. 1000 Sq. Ft. GLA: 27
Directional Distribution: 51% entering, 49% exiting

Vehicle Trip Generation per 1000 Sq. Ft. GLA

Average Rate	Range of Rates	Standard Deviation
6.57	1.88 - 14.23	3.45

Data Plot and Equation

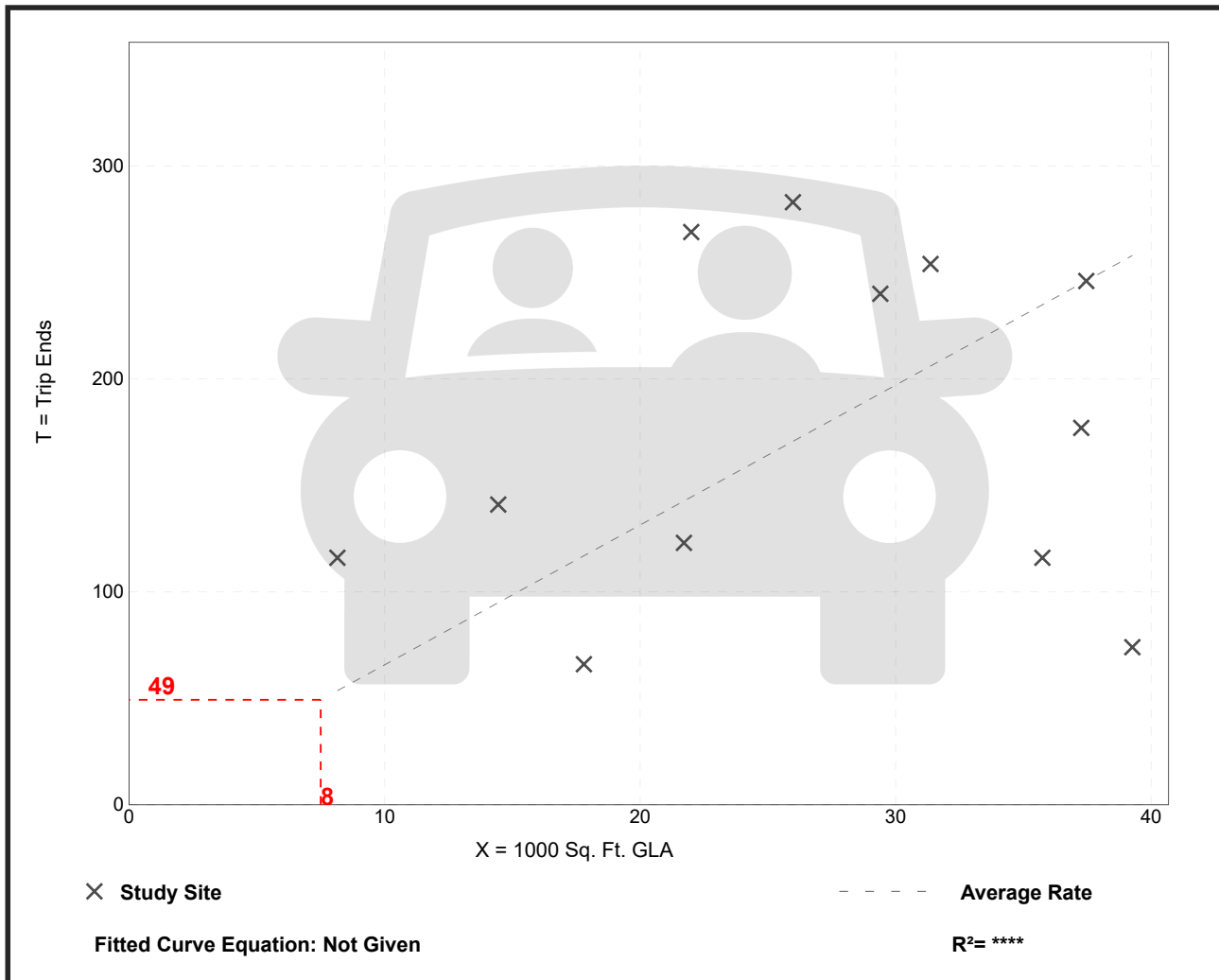

Land Use: 932

High-Turnover (Sit-Down) Restaurant

Description

This land use consists of sit-down, full-service eating establishments with a typical duration of stay of 60 minutes or less. This type of restaurant is usually moderately priced, frequently belongs to a restaurant chain, and is commonly referred to as casual dining. Generally, these restaurants serve lunch and dinner; they may also be open for breakfast and are sometimes open 24 hours a day. These restaurants typically do not accept reservations. A patron commonly waits to be seated, is served by wait staff, orders from a menu, and pays after the meal.

Some facilities offer carry-out for a small proportion of its customers. Some facilities within this land use may also contain a bar area for serving food and alcoholic drinks.

Fast casual restaurant (Land Use 930), fine dining restaurant (Land Use 931), fast-food restaurant without drive-through window (Land Use 933), and fast-food restaurant with drive-through window (Land Use 934) are related uses.

Additional Data

Users should exercise caution when applying statistics during the AM peak periods, as the sites contained in the database for this land use may or may not be open for breakfast. In cases where it was confirmed that the sites were not open for breakfast, data for the AM peak hour of the adjacent street traffic were removed from the database.

If the restaurant has outdoor seating, its area is not included in the overall gross floor area. For a restaurant that has significant outdoor seating, the number of seats may be more reliable than GFA as an independent variable on which to establish a trip generation rate.

The technical appendices provide supporting information on time-of-day distributions for this land use. The appendices can be accessed through either the ITETripGen web app or the trip generation resource page on the ITE website (<https://www.ite.org/technical-resources/topics/trip-and-parking-generation/>).

The sites were surveyed in the 1980s, the 1990s, the 2000s, and the 2010s in Alberta (CAN), California, Florida, Georgia, Indiana, Kentucky, Massachusetts, Minnesota, New Hampshire, New Jersey, New York, Ohio, Oklahoma, Oregon, Pennsylvania, South Carolina, South Dakota, Texas, Vermont, and Wisconsin.

Source Numbers

126, 269, 275, 280, 300, 301, 305, 338, 340, 341, 358, 384, 424, 432, 437, 438, 444, 507, 555, 577, 589, 617, 618, 728, 868, 884, 885, 903, 927, 939, 944, 961, 962, 977, 1048

High-Turnover (Sit-Down) Restaurant (932)

Vehicle Trip Ends vs: 1000 Sq. Ft. GFA
On a: Weekday

Setting/Location: General Urban/Suburban
Number of Studies: 50
Avg. 1000 Sq. Ft. GFA: 5
Directional Distribution: 50% entering, 50% exiting

Vehicle Trip Generation per 1000 Sq. Ft. GFA

Average Rate	Range of Rates	Standard Deviation
107.20	13.04 - 742.41	66.72

Data Plot and Equation

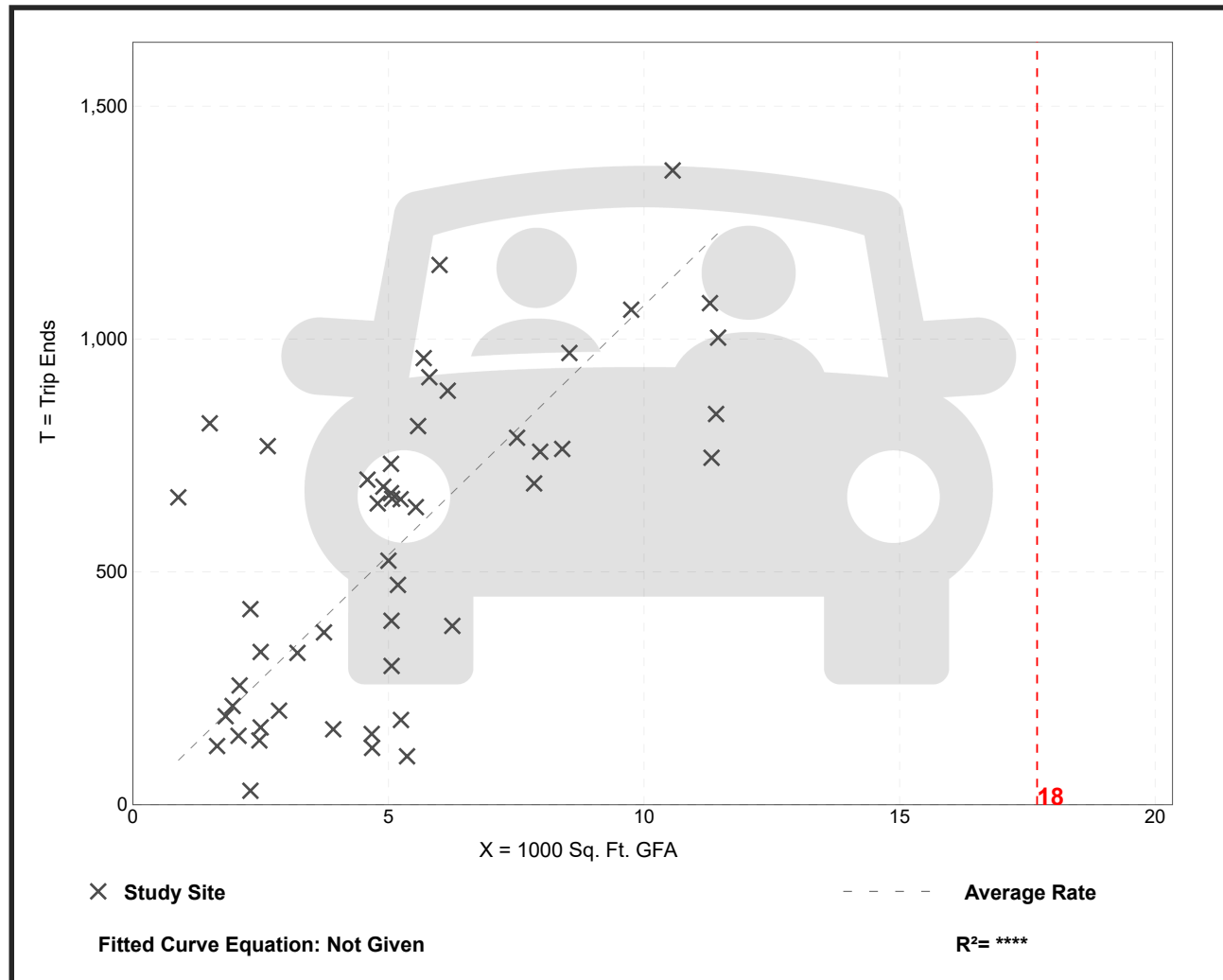

High-Turnover (Sit-Down) Restaurant (932)

Vehicle Trip Ends vs: 1000 Sq. Ft. GFA
 On a: Weekday,
 Peak Hour of Adjacent Street Traffic,
 One Hour Between 7 and 9 a.m.
 Setting/Location: General Urban/Suburban
 Number of Studies: 37
 Avg. 1000 Sq. Ft. GFA: 5
 Directional Distribution: 55% entering, 45% exiting

Vehicle Trip Generation per 1000 Sq. Ft. GFA

Average Rate	Range of Rates	Standard Deviation
9.57	0.76 - 102.39	11.61

Data Plot and Equation

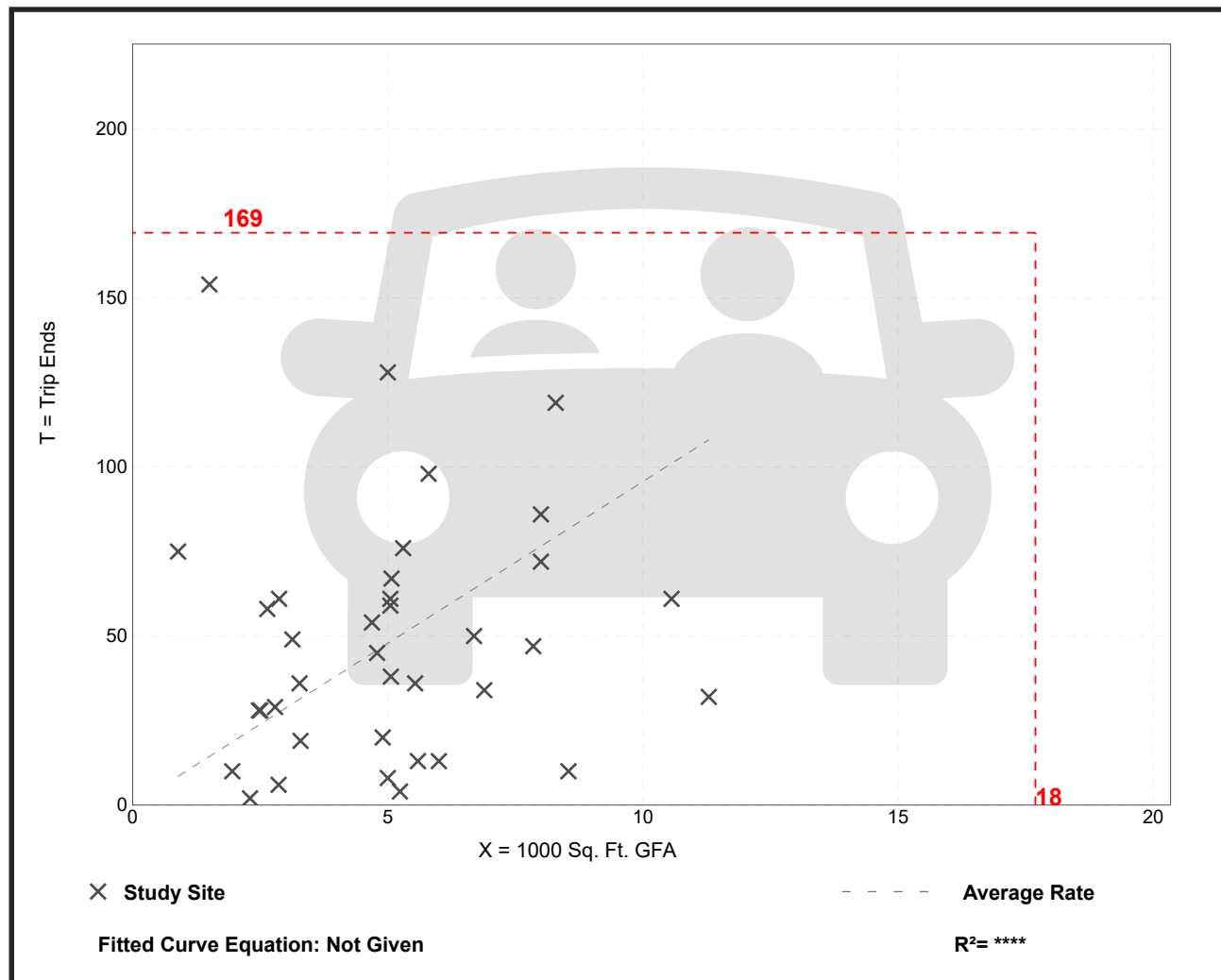

High-Turnover (Sit-Down) Restaurant (932)

Vehicle Trip Ends vs: 1000 Sq. Ft. GFA
On a: Weekday,
Peak Hour of Adjacent Street Traffic,
One Hour Between 4 and 6 p.m.
Setting/Location: General Urban/Suburban
 Number of Studies: 104
 Avg. 1000 Sq. Ft. GFA: 6
 Directional Distribution: 61% entering, 39% exiting

Vehicle Trip Generation per 1000 Sq. Ft. GFA

Average Rate	Range of Rates	Standard Deviation
9.05	0.92 - 62.00	6.18

Data Plot and Equation

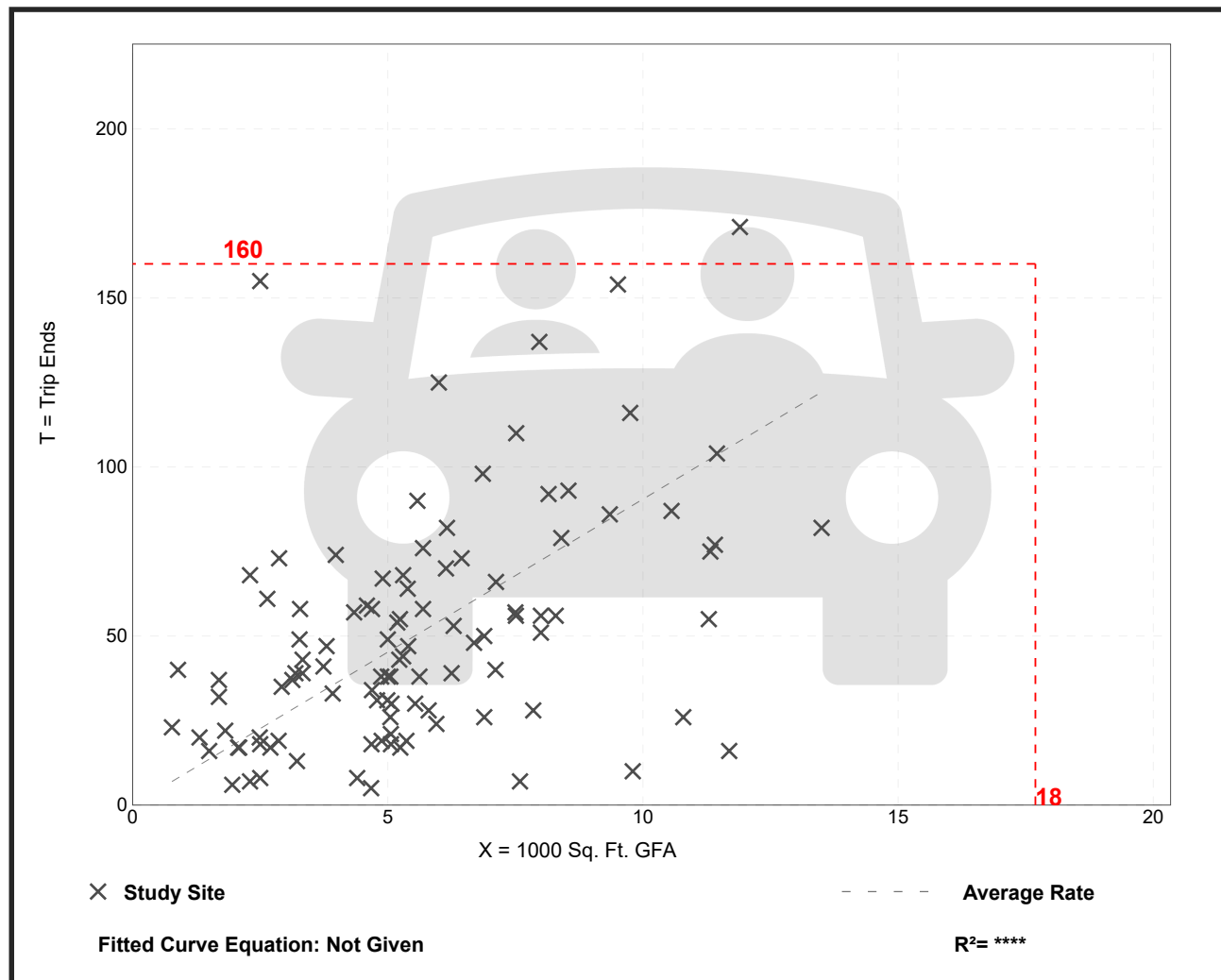

High-Turnover (Sit-Down) Restaurant (932)

Vehicle Trip Ends vs: 1000 Sq. Ft. GFA
On a: Saturday, Peak Hour of Generator

Setting/Location: General Urban/Suburban
Number of Studies: 22
Avg. 1000 Sq. Ft. GFA: 5
Directional Distribution: 51% entering, 49% exiting

Vehicle Trip Generation per 1000 Sq. Ft. GFA

Average Rate	Range of Rates	Standard Deviation
11.19	1.63 - 50.40	8.30

Data Plot and Equation

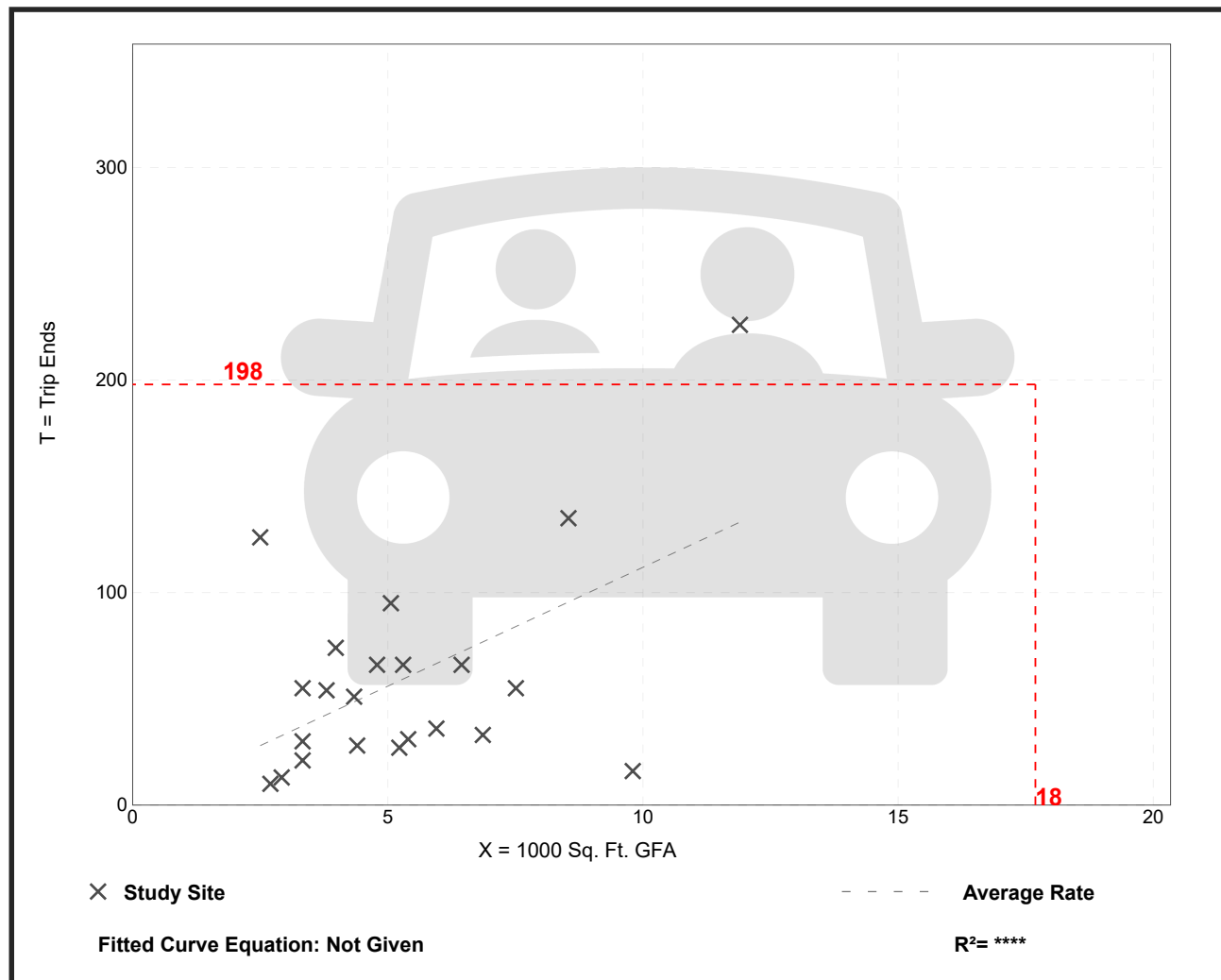

Land Use: 934

Fast-Food Restaurant with Drive-Through Window

Description

This land use includes any fast-food restaurant with a drive-through window. This type of restaurant is characterized by a large drive-through and large carry-out clientele, long hours of service (some are open for breakfast, all are open for lunch and dinner, some are open late at night or 24 hours a day) and high turnover rates for eat-in customers. The restaurant does not provide table service. A patron generally orders from a menu board and pays before receiving the meal. A typical duration of stay for an eat-in patron is less than 30 minutes. Fast casual restaurant (Land Use 930), high-turnover (sit-down) restaurant (Land Use 932), fast-food restaurant without drive-through window (Land Use 933), and fast-food restaurant with drive-through window and no indoor seating (Land Use 935) are related uses.

Additional Data

Users should exercise caution when applying statistics during the AM peak periods, as the sites contained in the database for this land use may or may not be open for breakfast. In cases where it was confirmed that the sites were not open for breakfast, data for the AM peak hour of the adjacent street traffic were removed from the database.

If the restaurant has outdoor seating, its area is not included in the overall gross floor area. For a restaurant that has significant outdoor seating, the number of seats may be more reliable than GFA as an independent variable on which to establish a trip generation rate.

The technical appendices provide supporting information on time-of-day distributions for this land use. The appendices can be accessed through either the ITETripGen web app or the trip generation resource page on the ITE website (<https://www.ite.org/technical-resources/topics/trip-and-parking-generation/>).

The sites were surveyed in the 1980s, the 1990s, the 2000s, and the 2010s in Alaska, Alberta (CAN), California, Colorado, Florida, Indiana, Kentucky, Maryland, Massachusetts, Minnesota, Montana, New Hampshire, New Jersey, New York, North Carolina, Ohio, Pennsylvania, South Dakota, Texas, Vermont, Virginia, Washington, and Wisconsin.

Source Numbers

163, 164, 168, 180, 181, 241, 245, 278, 294, 300, 301, 319, 338, 340, 342, 358, 389, 438, 502, 552, 577, 583, 584, 617, 640, 641, 704, 715, 728, 810, 866, 867, 869, 885, 886, 927, 935, 962, 977, 1050, 1053, 1054

Fast-Food Restaurant with Drive-Through Window (934)

Vehicle Trip Ends vs: 1000 Sq. Ft. GFA
On a: Weekday

Setting/Location: General Urban/Suburban
Number of Studies: 71
Avg. 1000 Sq. Ft. GFA: 3
Directional Distribution: 50% entering, 50% exiting

Vehicle Trip Generation per 1000 Sq. Ft. GFA

Average Rate	Range of Rates	Standard Deviation
467.48	98.89 - 1137.66	238.62

Data Plot and Equation

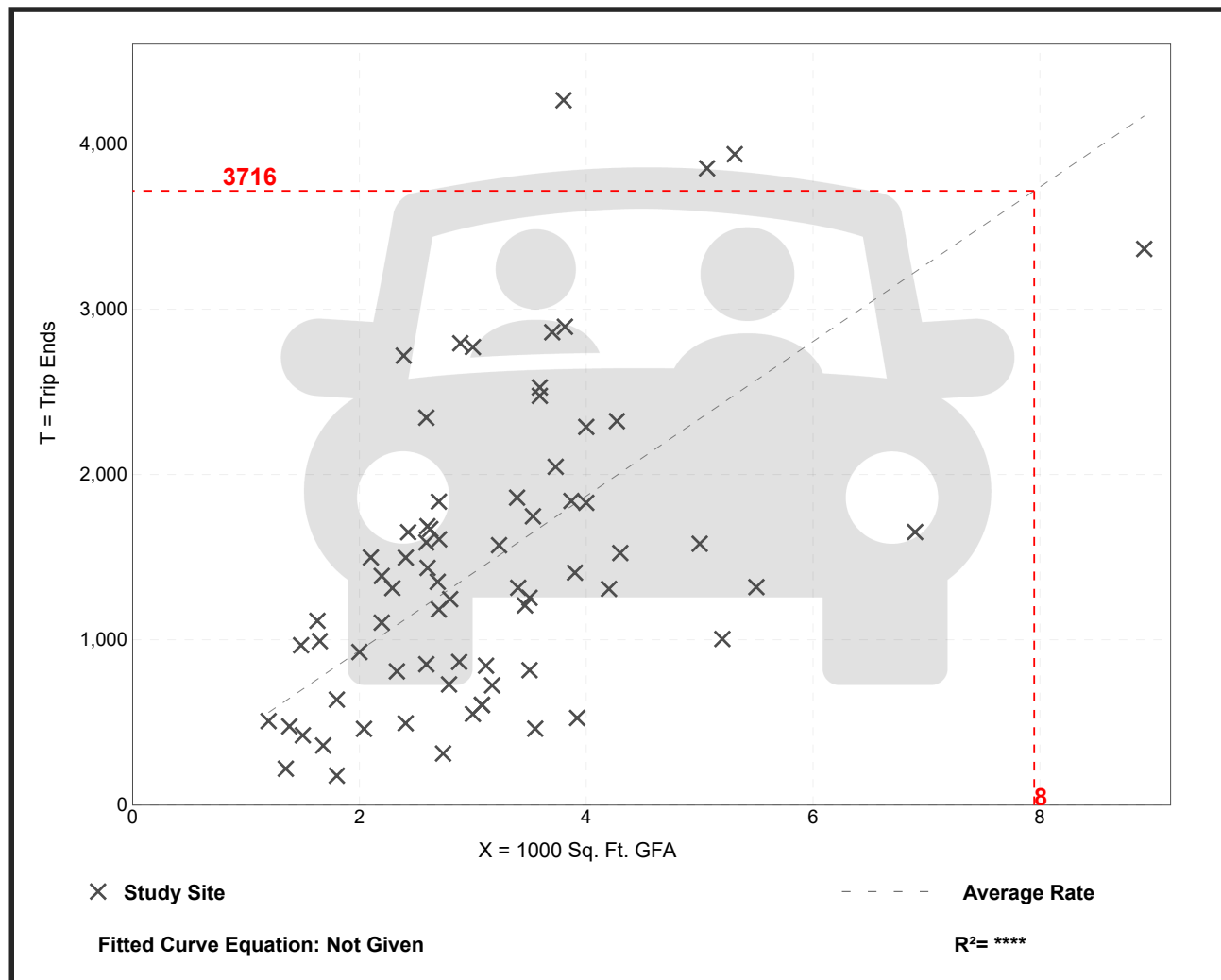

Fast-Food Restaurant with Drive-Through Window (934)

Vehicle Trip Ends vs: 1000 Sq. Ft. GFA
 On a: Weekday,
 Peak Hour of Adjacent Street Traffic,
 One Hour Between 7 and 9 a.m.
 Setting/Location: General Urban/Suburban
 Number of Studies: 96
 Avg. 1000 Sq. Ft. GFA: 4
 Directional Distribution: 51% entering, 49% exiting

Vehicle Trip Generation per 1000 Sq. Ft. GFA

Average Rate	Range of Rates	Standard Deviation
44.61	1.05 - 164.25	27.14

Data Plot and Equation

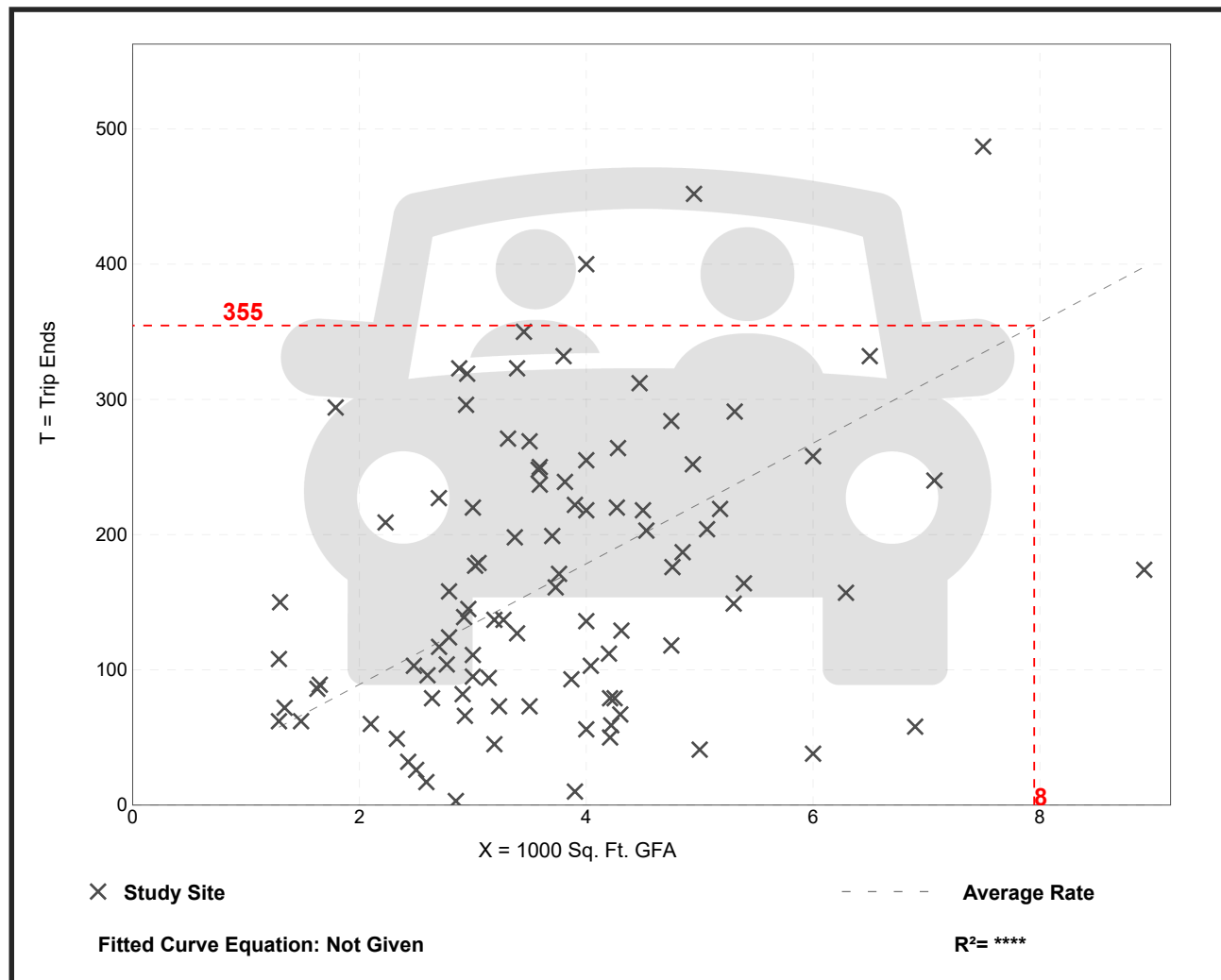

Fast-Food Restaurant with Drive-Through Window (934)

Vehicle Trip Ends vs: 1000 Sq. Ft. GFA
 On a: Weekday,
 Peak Hour of Adjacent Street Traffic,
 One Hour Between 4 and 6 p.m.
 Setting/Location: General Urban/Suburban
 Number of Studies: 190
 Avg. 1000 Sq. Ft. GFA: 3
 Directional Distribution: 52% entering, 48% exiting

Vehicle Trip Generation per 1000 Sq. Ft. GFA

Average Rate	Range of Rates	Standard Deviation
33.03	8.77 - 117.22	17.59

Data Plot and Equation

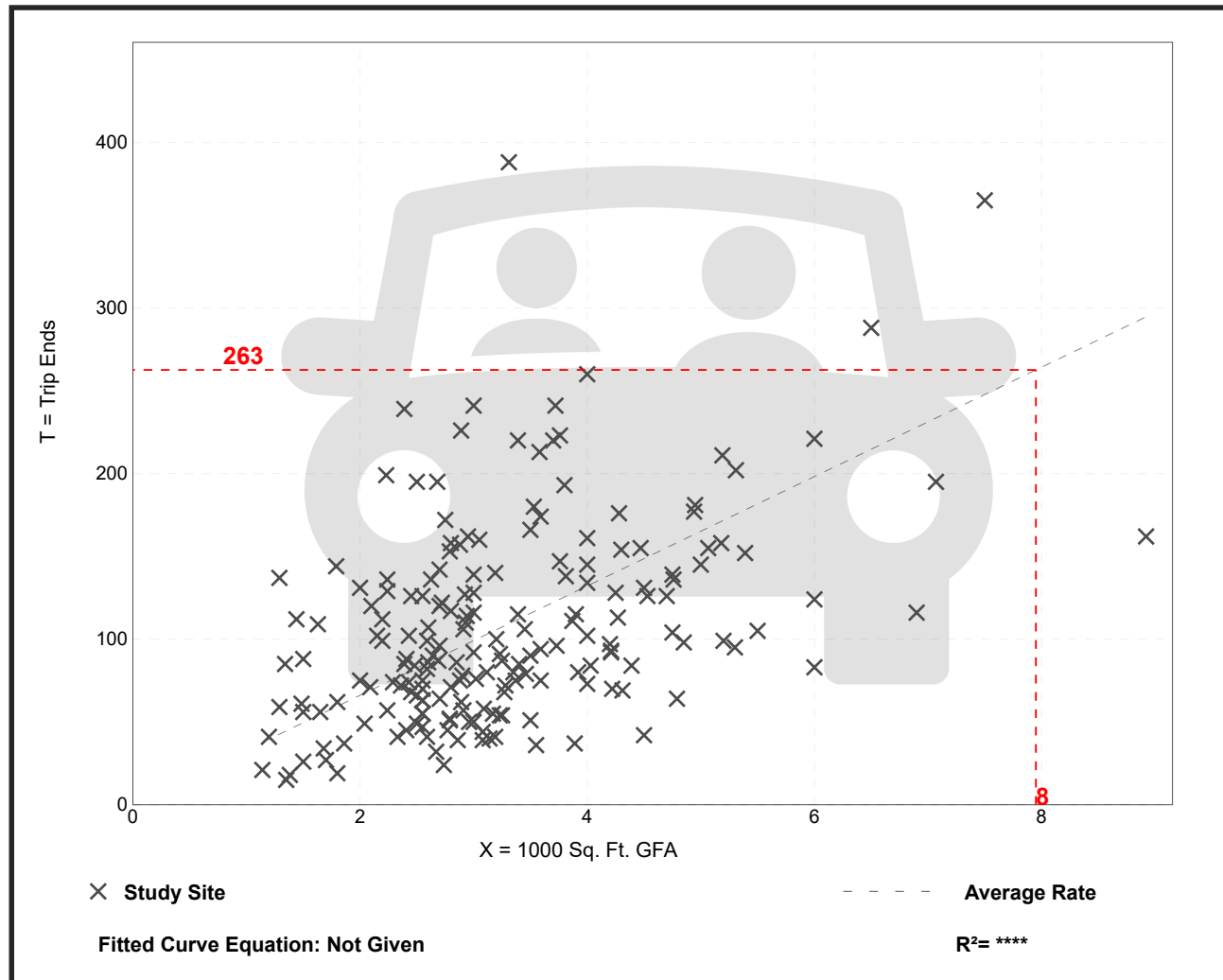

Land Use: 937

Coffee/Donut Shop with Drive-Through Window

Description

This land use includes any coffee and donut restaurant that has a drive-through window as well as a walk-in entrance area at which a patron can purchase and consume items. The restaurant sells freshly brewed coffee (along with coffee-related accessories) and a variety of food/drink products such as donuts, bagels, breads, muffins, cakes, sandwiches, wraps, salads, and other hot and cold beverages. The restaurant marketing and sales may emphasize coffee beverages over food (or vice versa).

A coffee/donut shop typically holds long store hours (more than 15 hours) with an early morning opening. Limited indoor seating is generally provided for patrons, but table service is not provided.

Coffee/donut shop without drive-through window (Land Use 936) and coffee/donut shop with drive-through window and no indoor seating (Land Use 938) are related uses.

Additional Data

The sites were surveyed in the 1990s, the 2000s, and the 2010s in California, Colorado, Connecticut, Illinois, Massachusetts, Minnesota, Nevada, New Hampshire, New Jersey, New York, Ontario (CAN), Pennsylvania, Quebec (CAN), Tennessee, Vermont, Washington, and Wisconsin.

Specialized Land Use Data

One study was conducted during the pandemic in 2020. Twelve sites were counted in Illinois and Missouri during the AM and PM adjacent street peak hours. The data have not been incorporated within the overall ITE trip generation database and are not reflected in the data plots for this land use. Consideration for their inclusion will be given for the 12th Edition of *Trip Generation Manual* after additional post-pandemic data are collected. Overall, the pandemic counts yielded an AM adjacent street peak weighted average rate of 84 vehicle trips per 1,000 square feet GFA, roughly equivalent to the pre-pandemic average. The PM adjacent street peak rate was 56 (roughly 40 percent higher than the pre-pandemic value). The higher PM peak rate for these coffee/donut shops conforms with anecdotal observations that with the temporary or permanent closures of many restaurants during the pandemic, the drive-through restaurants that were open did a brisk business even during their off-peak periods.

Source Numbers

594, 599, 615, 617, 618, 621, 622, 635, 639, 712, 714, 725, 726, 728, 853, 854, 892, 903, 928, 959, 979, 982, 1004, 1042, 1044

Coffee/Donut Shop with Drive-Through Window (937)

Vehicle Trip Ends vs: 1000 Sq. Ft. GFA
On a: Weekday

Setting/Location: General Urban/Suburban
Number of Studies: 6
Avg. 1000 Sq. Ft. GFA: 2
Directional Distribution: 50% entering, 50% exiting

Vehicle Trip Generation per 1000 Sq. Ft. GFA

Average Rate	Range of Rates	Standard Deviation
533.57	309.41 - 869.00	243.65

Data Plot and Equation

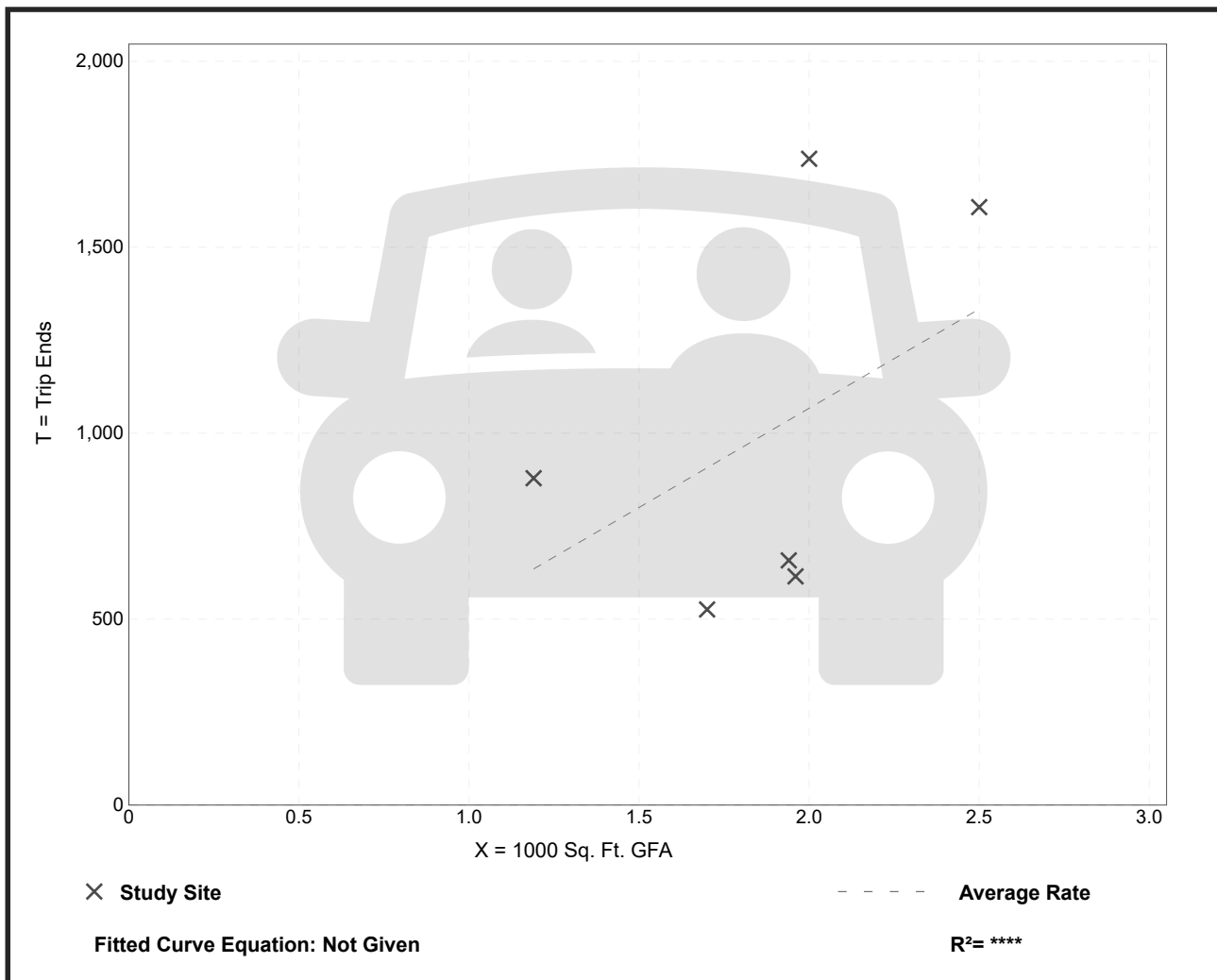

Coffee/Donut Shop with Drive-Through Window (937)

Vehicle Trip Ends vs: 1000 Sq. Ft. GFA
 On a: Weekday,
 Peak Hour of Adjacent Street Traffic,
 One Hour Between 4 and 6 p.m.
 Setting/Location: General Urban/Suburban
 Number of Studies: 36
 Avg. 1000 Sq. Ft. GFA: 2
 Directional Distribution: 50% entering, 50% exiting

Vehicle Trip Generation per 1000 Sq. Ft. GFA

Average Rate	Range of Rates	Standard Deviation
38.99	13.78 - 92.31	17.79

Data Plot and Equation

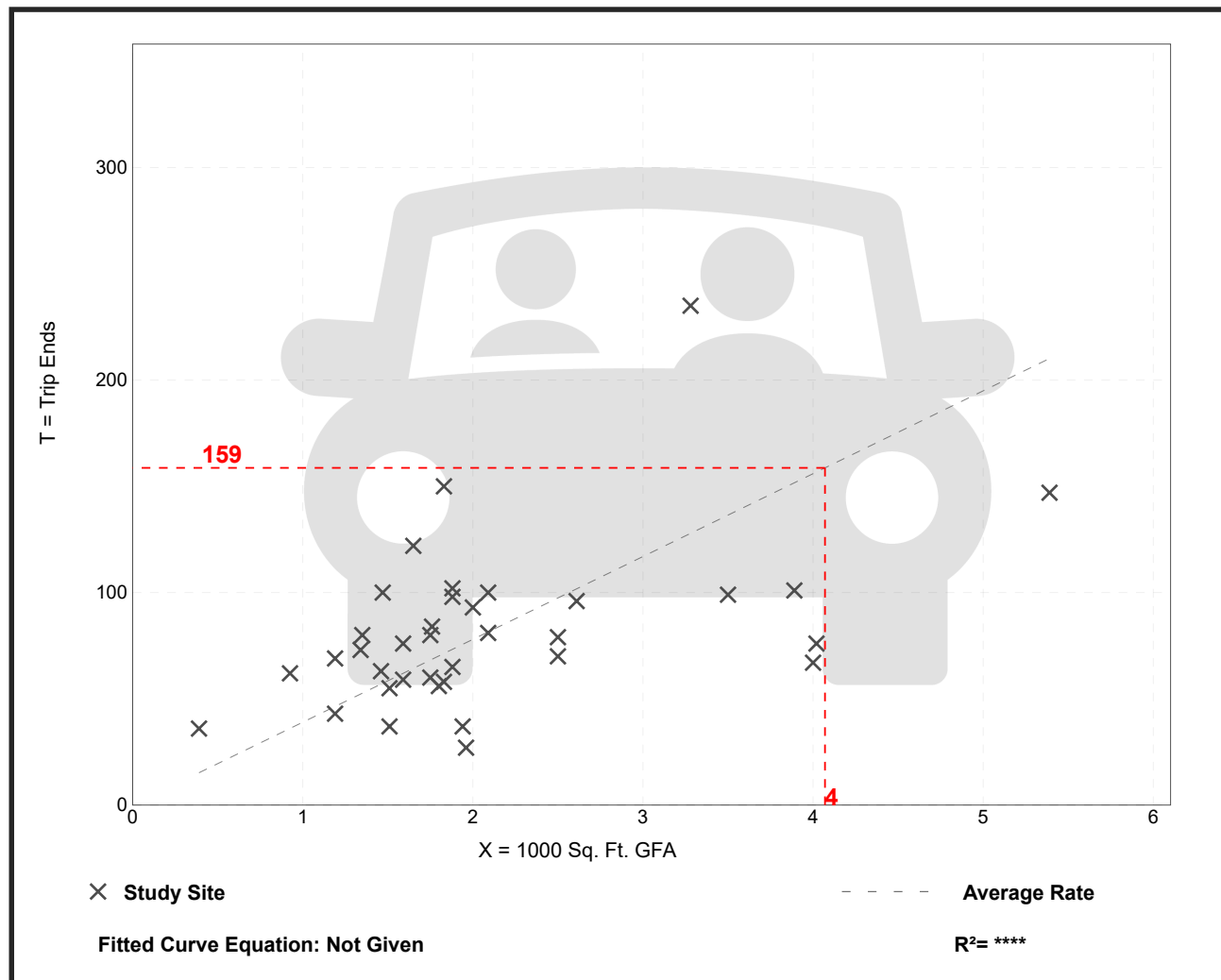

Coffee/Donut Shop with Drive-Through Window (937)

Vehicle Trip Ends vs: 1000 Sq. Ft. GFA
On a: Saturday, Peak Hour of Generator

Setting/Location: General Urban/Suburban
Number of Studies: 9
Avg. 1000 Sq. Ft. GFA: 2
Directional Distribution: 50% entering, 50% exiting

Vehicle Trip Generation per 1000 Sq. Ft. GFA

Average Rate	Range of Rates	Standard Deviation
87.91	48.42 - 138.28	34.34

Data Plot and Equation

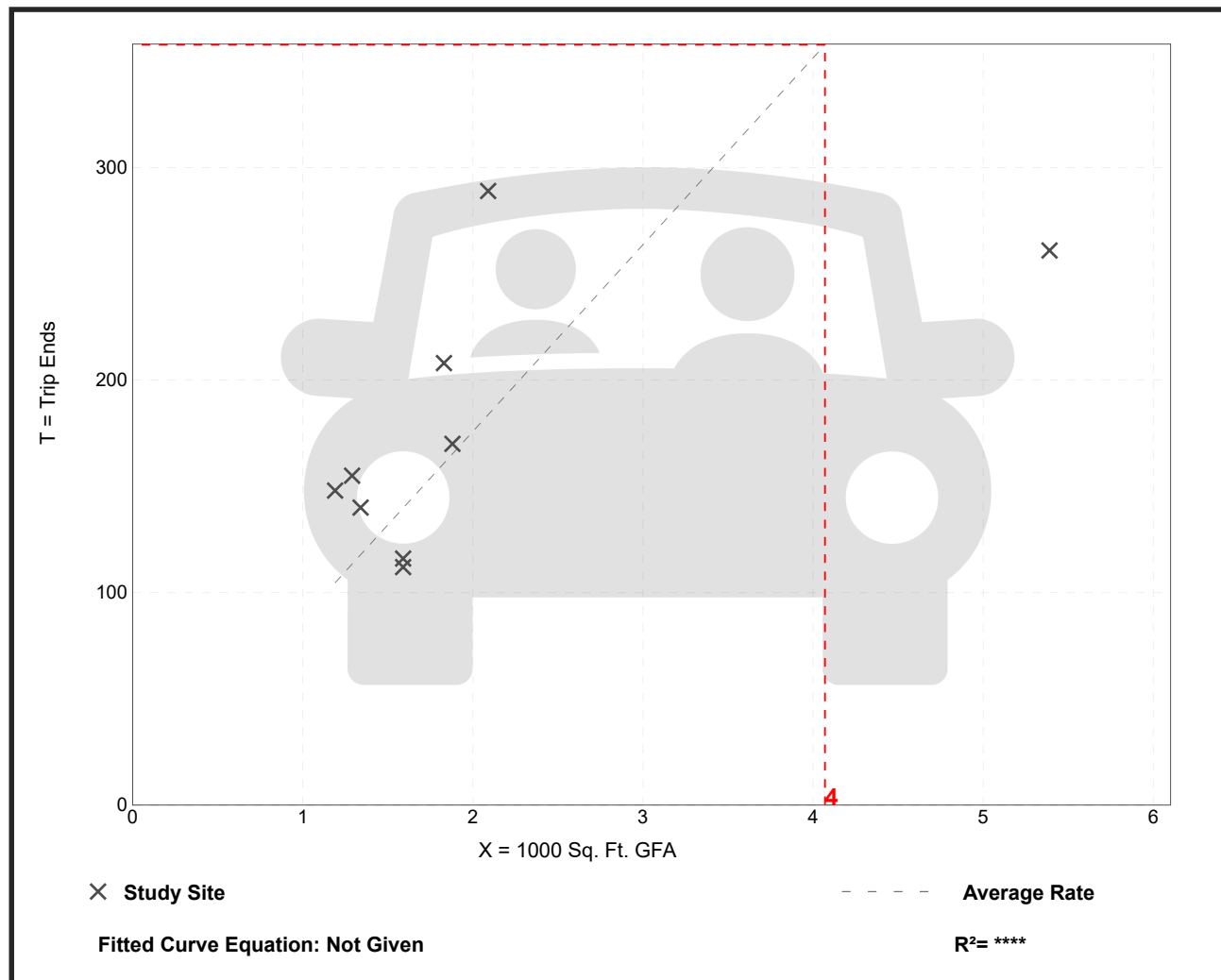

Land Use: 948

Automated Car Wash

Description

An automated car wash is a facility that allows for the mechanical cleaning of the exterior of vehicles. Manual cleaning service may also be available at the facility. Self-service car wash (Land Use 947) and car wash and detail center (Land Use 949) are related uses.

Additional Data

The sites were surveyed in the 1990s and the 2000s in New Jersey, New York, and Washington.

Source Numbers

552, 555, 585, 599, 954

Automated Car Wash (948)

Vehicle Trip Ends vs: Car Wash Tunnels
On a: Weekday,
Peak Hour of Adjacent Street Traffic,
One Hour Between 4 and 6 p.m.

Setting/Location: General Urban/Suburban

Number of Studies: 3
 Avg. Num. of Car Wash Tunnels: 1
 Directional Distribution: 50% entering, 50% exiting

Vehicle Trip Generation per Car Wash Tunnel

Average Rate	Range of Rates	Standard Deviation
77.50	50.00 - 104.50	33.07

Data Plot and Equation

Caution – Small Sample Size

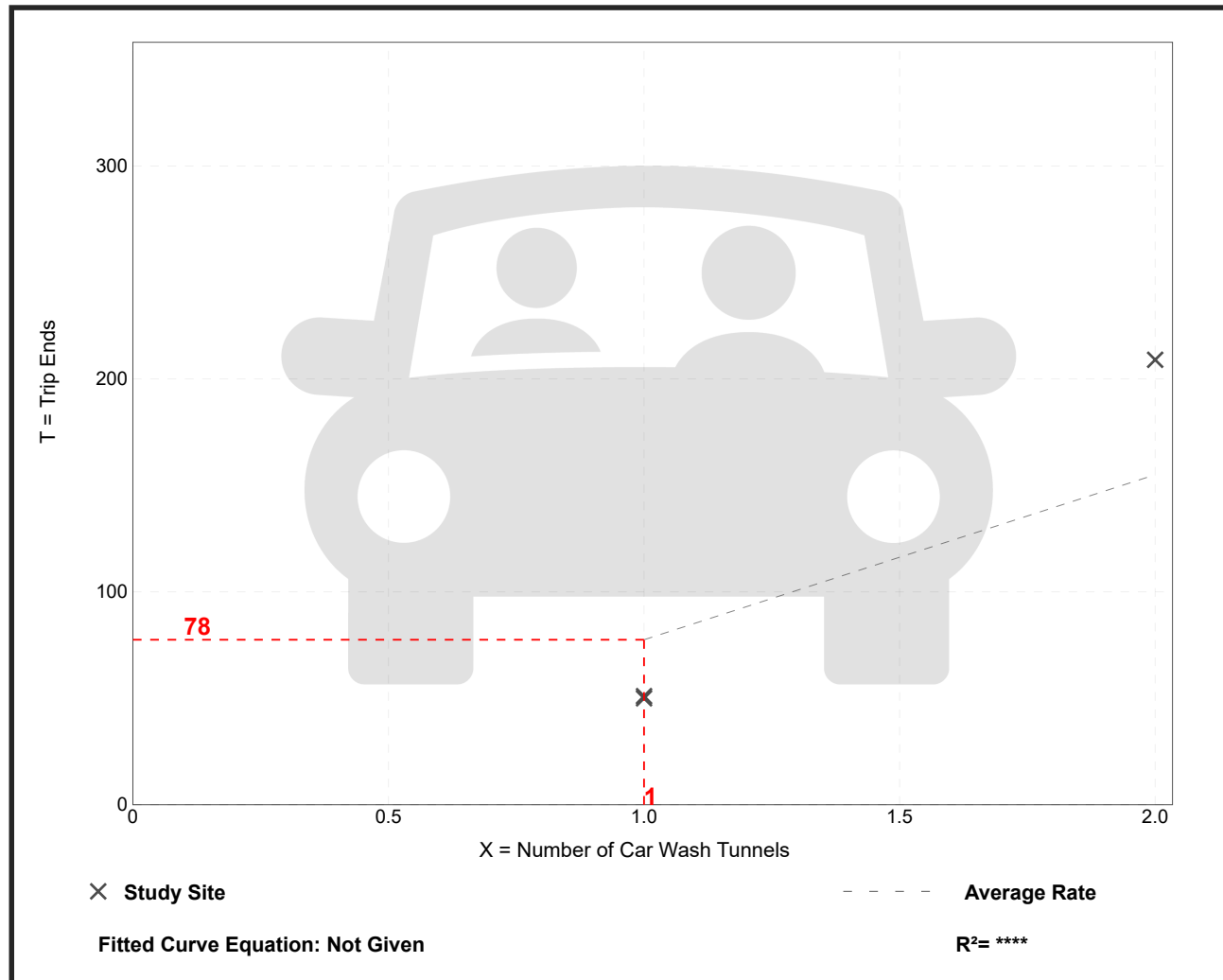

Automated Car Wash (948)

Vehicle Trip Ends vs: Car Wash Tunnels
On a: Saturday, Peak Hour of Generator

Setting/Location: General Urban/Suburban
Number of Studies: 1
Avg. Num. of Car Wash Tunnels: 1
Directional Distribution: 46% entering, 54% exiting

Vehicle Trip Generation per Car Wash Tunnel

Average Rate	Range of Rates	Standard Deviation
41.00	41.00 - 41.00	*

Data Plot and Equation

Caution – Small Sample Size

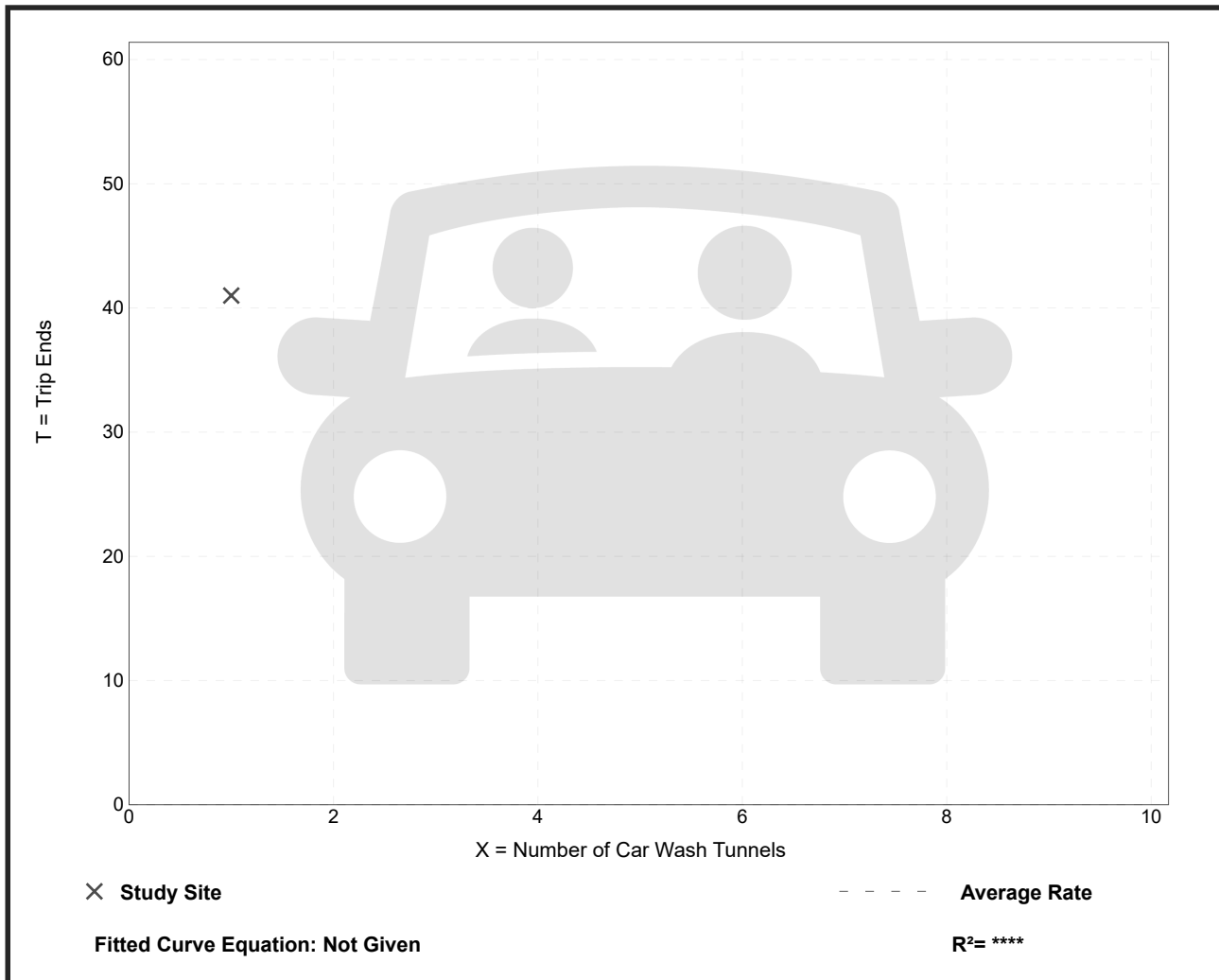

Phase 2

Land Use: 221

Multifamily Housing (Mid-Rise)

Description

Mid-rise multifamily housing includes apartments and condominiums located in a building that has between four and 10 floors of living space. Access to individual dwelling units is through an outside building entrance, a lobby, elevator, and a set of hallways.

Multifamily housing (low-rise) (Land Use 220), multifamily housing (high-rise) (Land Use 222), off-campus student apartment (mid-rise) (Land Use 226), and mid-rise residential with ground-floor commercial (Land Use 231) are related land uses.

Land Use Subcategory

Data are presented for two subcategories for this land use: (1) not close to rail transit and (2) close to rail transit. A site is considered close to rail transit if the walking distance between the residential site entrance and the closest rail transit station entrance is ½ mile or less.

Additional Data

For the six sites for which both the number of residents and the number of occupied dwelling units were available, there were an average of 2.5 residents per occupied dwelling unit.

For the five sites for which the numbers of both total dwelling units and occupied dwelling units were available, an average of 96 percent of the total dwelling units were occupied.

The technical appendices provide supporting information on time-of-day distributions for this land use. The appendices can be accessed through either the ITETripGen web app or the trip generation resource page on the ITE website (<https://www.ite.org/technical-resources/topics/trip-and-parking-generation/>).

It is expected that the number of bedrooms and number of residents are likely correlated to the trips generated by a residential site. To assist in future analysis, trip generation studies of all multifamily housing should attempt to obtain information on occupancy rate and on the mix of residential unit sizes (i.e., number of units by number of bedrooms at the site complex).

The sites were surveyed in the 1990s, the 2000s, the 2010s, and the 2020s in Alberta (CAN), California, District of Columbia, Florida, Georgia, Illinois, Maryland, Massachusetts, Minnesota, Montana, New Jersey, New York, Ontario (CAN), Oregon, Utah, and Virginia.

Source Numbers

168, 188, 204, 305, 306, 321, 818, 857, 862, 866, 901, 904, 910, 949, 951, 959, 963, 964, 966, 967, 969, 970, 1004, 1014, 1022, 1023, 1025, 1031, 1032, 1035, 1047, 1056, 1057, 1058, 1071, 1076

Multifamily Housing (Mid-Rise) Not Close to Rail Transit (221)

Vehicle Trip Ends vs: Dwelling Units
On a: Weekday

Setting/Location: General Urban/Suburban
Number of Studies: 11
Avg. Num. of Dwelling Units: 201
Directional Distribution: 50% entering, 50% exiting

Vehicle Trip Generation per Dwelling Unit

Average Rate	Range of Rates	Standard Deviation
4.54	3.76 - 5.40	0.51

Data Plot and Equation

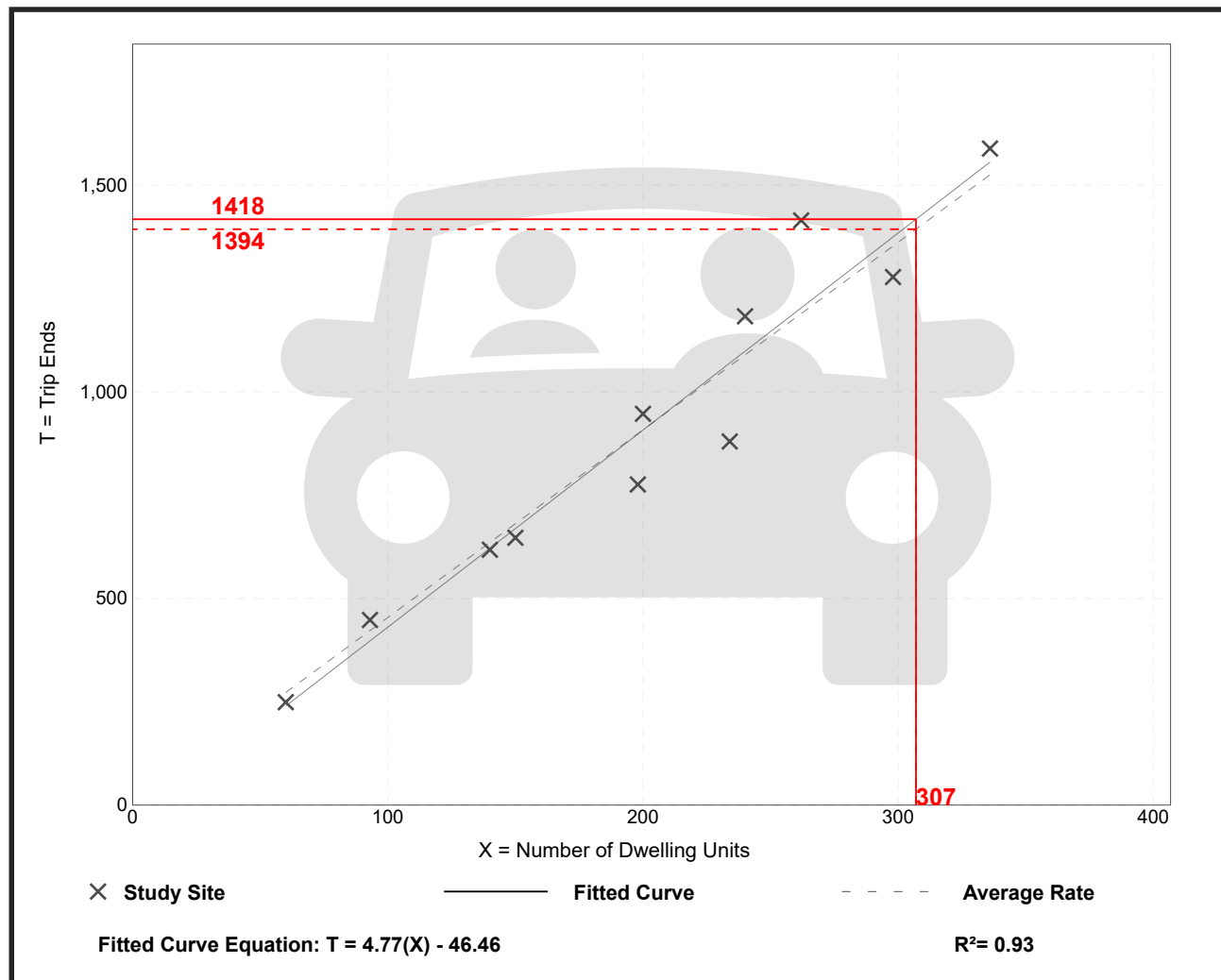

Multifamily Housing (Mid-Rise) Not Close to Rail Transit (221)

Vehicle Trip Ends vs: Dwelling Units
 On a: Weekday,
 Peak Hour of Adjacent Street Traffic,
 One Hour Between 7 and 9 a.m.

Setting/Location: General Urban/Suburban

Number of Studies: 30
 Avg. Num. of Dwelling Units: 173
 Directional Distribution: 23% entering, 77% exiting

Vehicle Trip Generation per Dwelling Unit

Average Rate	Range of Rates	Standard Deviation
0.37	0.15 - 0.53	0.09

Data Plot and Equation

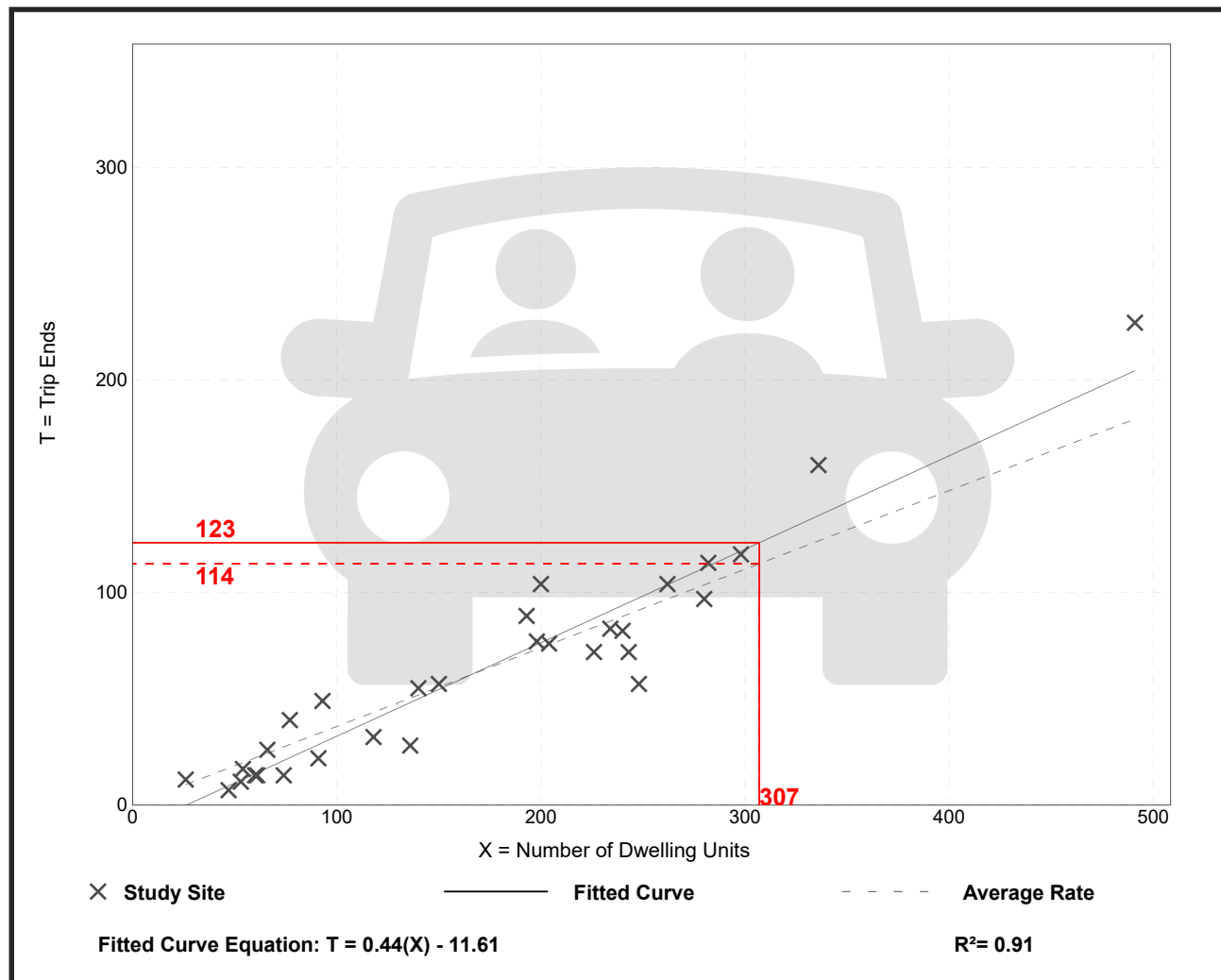

Multifamily Housing (Mid-Rise) Not Close to Rail Transit (221)

Vehicle Trip Ends vs: Dwelling Units
On a: Weekday,
Peak Hour of Adjacent Street Traffic,
One Hour Between 4 and 6 p.m.

Setting/Location: General Urban/Suburban
 Number of Studies: 31
 Avg. Num. of Dwelling Units: 169
 Directional Distribution: 61% entering, 39% exiting

Vehicle Trip Generation per Dwelling Unit

Average Rate	Range of Rates	Standard Deviation
0.39	0.19 - 0.57	0.08

Data Plot and Equation

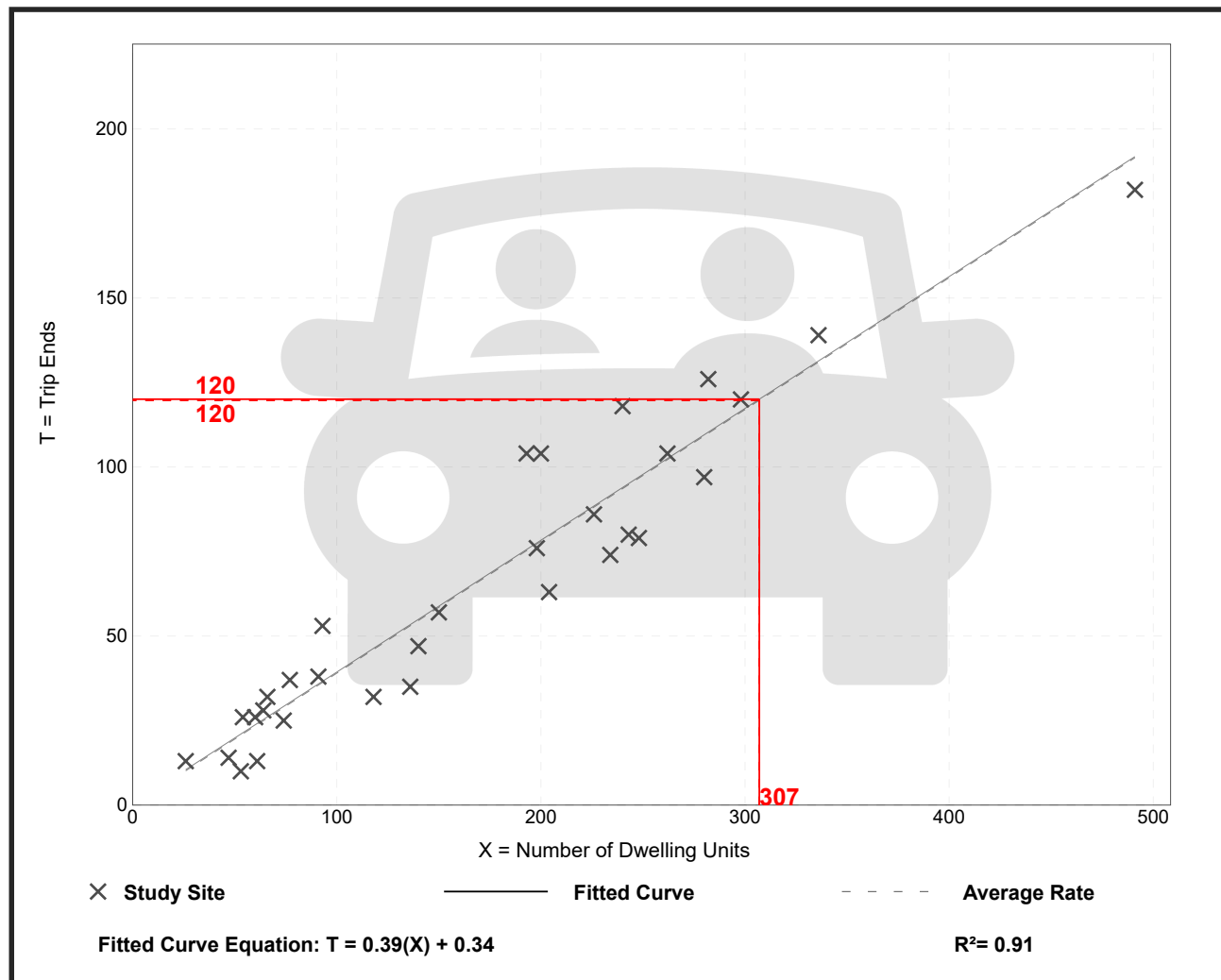

Multifamily Housing (Mid-Rise) Not Close to Rail Transit (221)

Vehicle Trip Ends vs: Dwelling Units
On a: Saturday, Peak Hour of Generator

Setting/Location: General Urban/Suburban
Number of Studies: 5
Avg. Num. of Dwelling Units: 250
Directional Distribution: 51% entering, 49% exiting

Vehicle Trip Generation per Dwelling Unit

Average Rate	Range of Rates	Standard Deviation
0.39	0.34 - 0.43	0.04

Data Plot and Equation

Caution – Small Sample Size

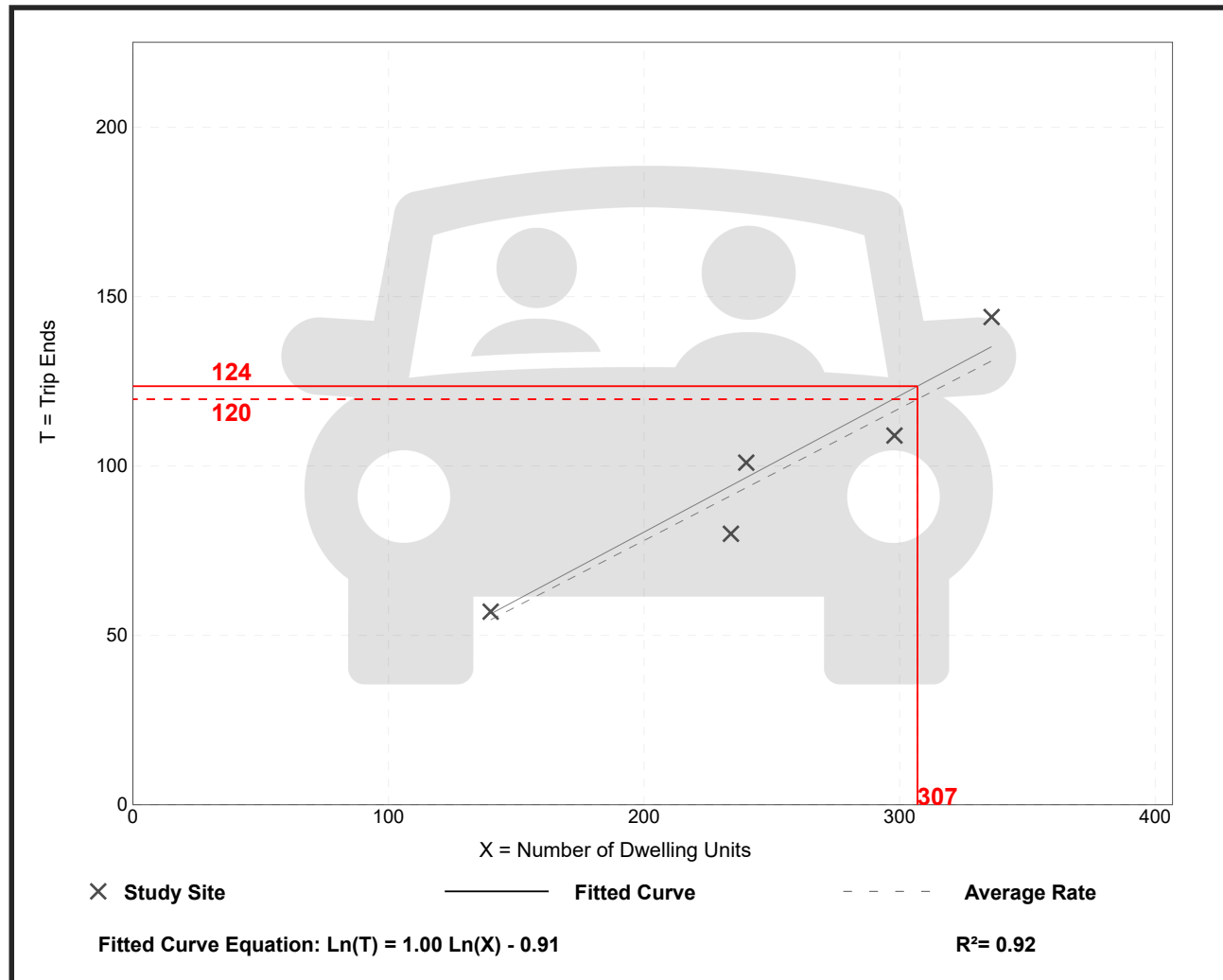

Land Use: 822

Strip Retail Plaza (<40k)

Description

A strip retail plaza is an integrated group of commercial establishments that is planned, developed, owned, and managed as a unit. Each study site in this land use has less than 40,000 square feet of gross leasable area (GLA). Because a strip retail plaza is open-air, the GLA is the same as the gross floor area of the building.

The 40,000 square feet GFA threshold between strip retail plaza and shopping plaza (Land Use 821) was selected based on an examination of the overall shopping center/plaza database. No shopping plaza with a supermarket as its anchor is smaller than 40,000 square feet GLA.

Shopping center (>150k) (Land use 820), shopping plaza (40-150k) (Land Use 821), and factory outlet center (Land Use 823) are related uses.

Additional Data

The technical appendices provide supporting information on time-of-day distributions for this land use. The appendices can be accessed through either the ITETripGen web app or the trip generation resource page on the ITE website (<https://www.ite.org/technical-resources/topics/trip-and-parking-generation/>).

The sites were surveyed in the 1980s, the 1990s, the 2000s, and the 2010s in Alberta (CAN), California, Delaware, Florida, New Jersey, Ontario (CAN), South Dakota, Vermont, Washington, and Wisconsin.

Source Numbers

304, 358, 423, 428, 437, 507, 715, 728, 936, 960, 961, 974, 1009

Strip Retail Plaza (<40k) (822)

Vehicle Trip Ends vs: 1000 Sq. Ft. GLA
On a: Weekday

Setting/Location: General Urban/Suburban
Number of Studies: 4
Avg. 1000 Sq. Ft. GLA: 19
Directional Distribution: 50% entering, 50% exiting

Vehicle Trip Generation per 1000 Sq. Ft. GLA

Average Rate	Range of Rates	Standard Deviation
54.45	47.86 - 65.07	7.81

Data Plot and Equation

Caution – Small Sample Size

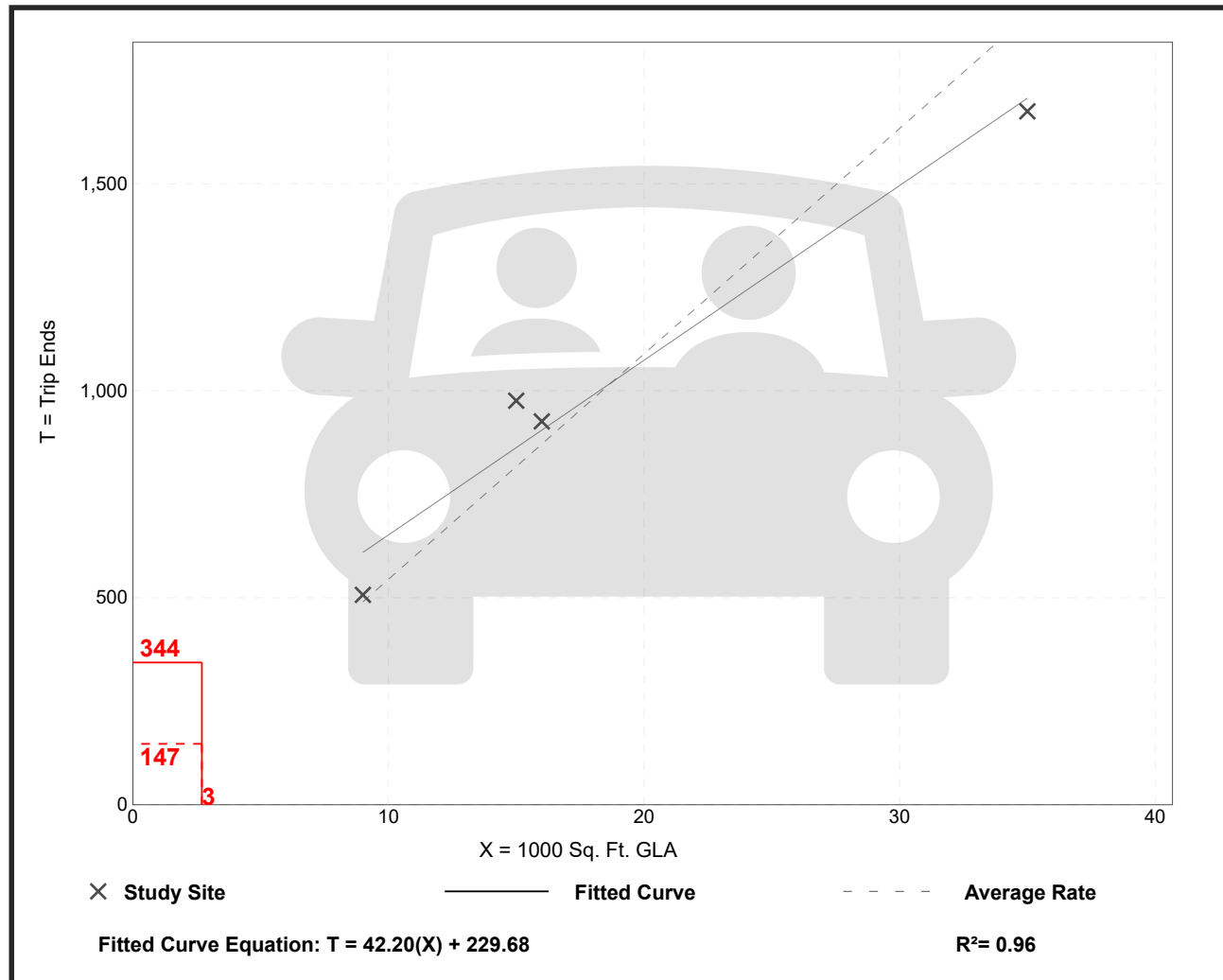

Strip Retail Plaza (<40k) (822)

Vehicle Trip Ends vs: 1000 Sq. Ft. GLA
On a: Weekday,
Peak Hour of Adjacent Street Traffic,
One Hour Between 7 and 9 a.m.
Setting/Location: General Urban/Suburban
 Number of Studies: 5
 Avg. 1000 Sq. Ft. GLA: 18
 Directional Distribution: 60% entering, 40% exiting

Vehicle Trip Generation per 1000 Sq. Ft. GLA

Average Rate	Range of Rates	Standard Deviation
2.36	1.60 - 3.73	0.94

Data Plot and Equation

Caution – Small Sample Size

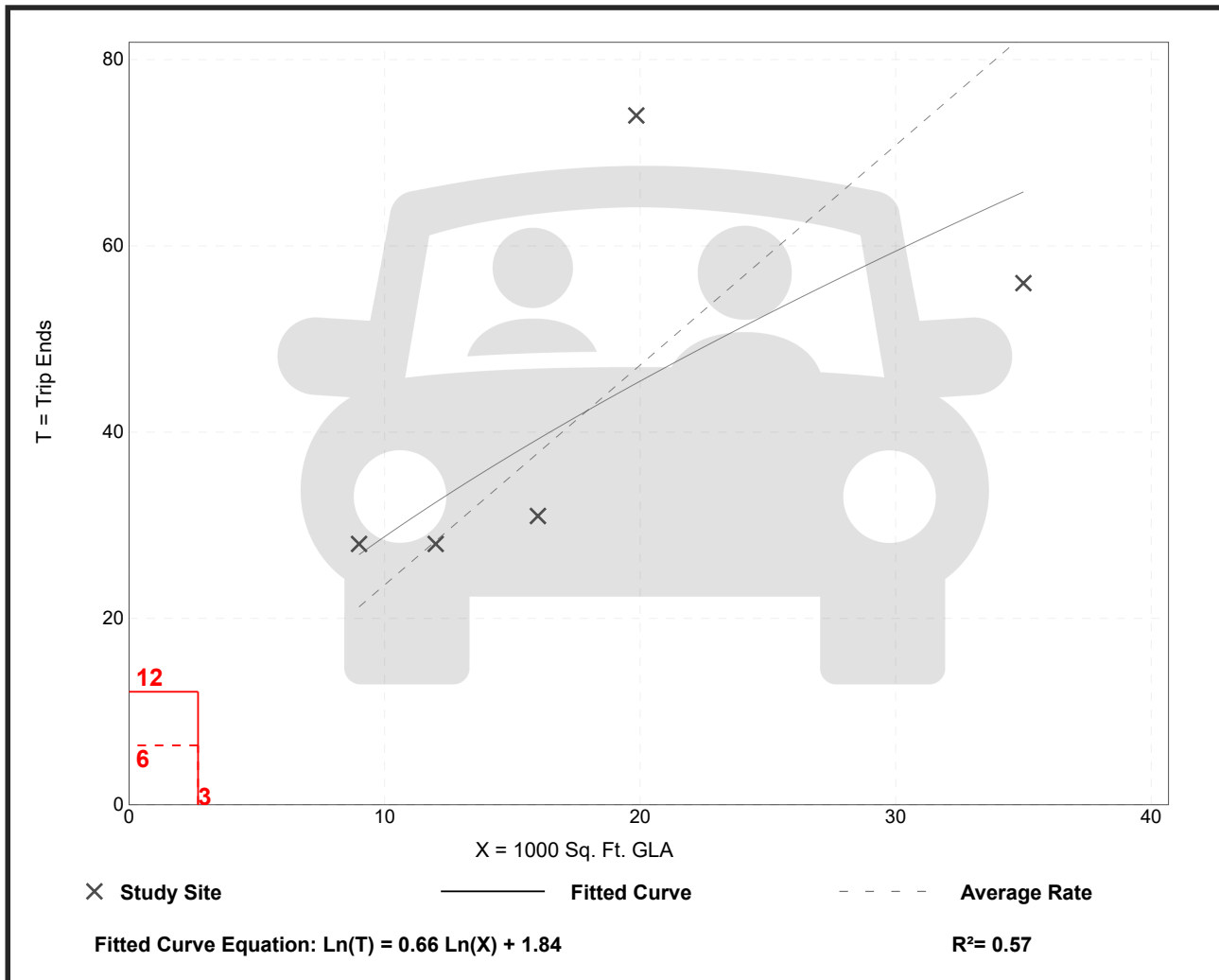

Strip Retail Plaza (<40k) (822)

Vehicle Trip Ends vs: 1000 Sq. Ft. GLA
On a: Weekday,
Peak Hour of Adjacent Street Traffic,
One Hour Between 4 and 6 p.m.

Setting/Location: General Urban/Suburban
 Number of Studies: 25
 Avg. 1000 Sq. Ft. GLA: 21
 Directional Distribution: 50% entering, 50% exiting

Vehicle Trip Generation per 1000 Sq. Ft. GLA

Average Rate	Range of Rates	Standard Deviation
6.59	2.81 - 15.20	2.94

Data Plot and Equation

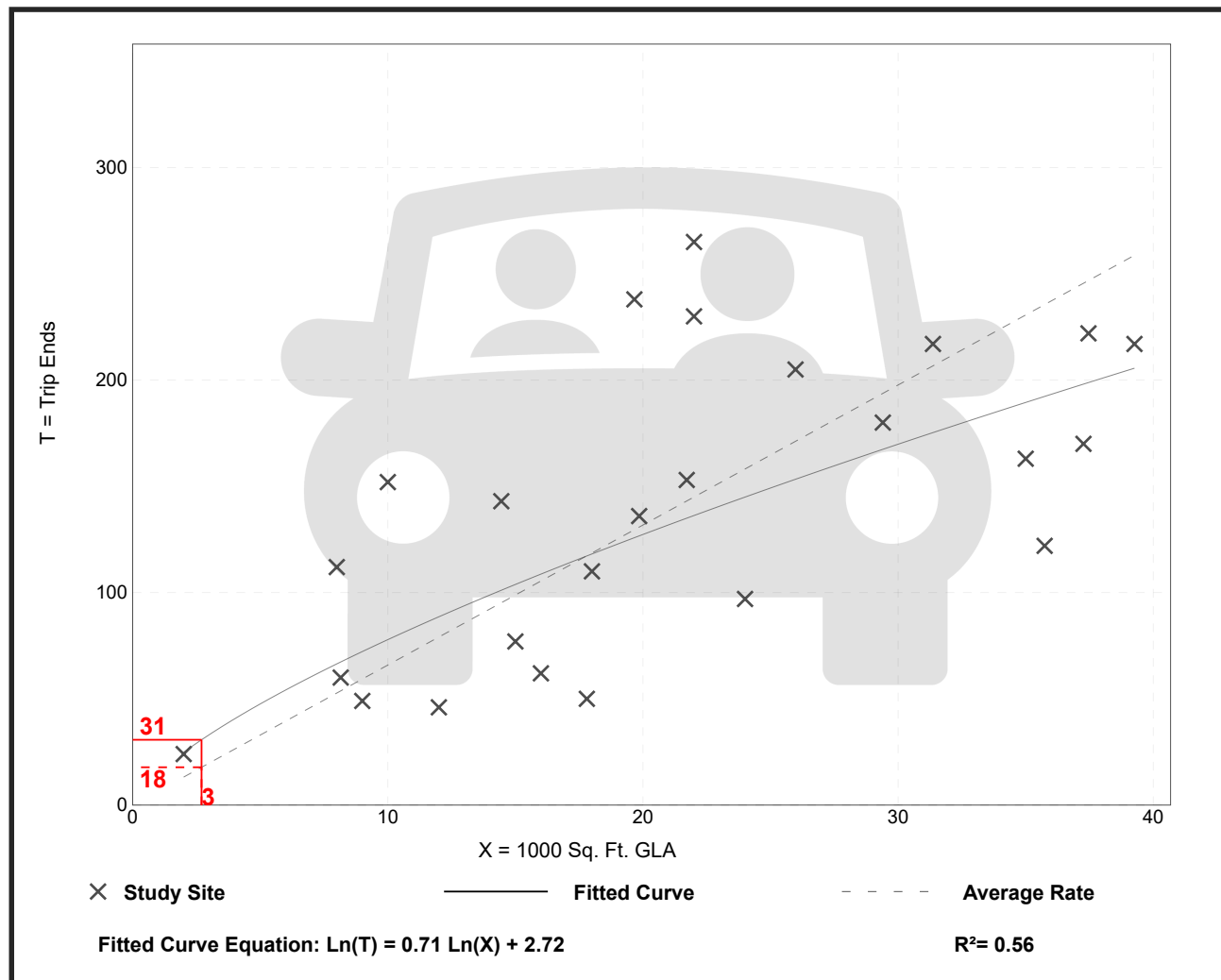

Strip Retail Plaza (<40k) (822)

Vehicle Trip Ends vs: 1000 Sq. Ft. GLA
On a: Saturday, Peak Hour of Generator

Setting/Location: General Urban/Suburban
Number of Studies: 12
Avg. 1000 Sq. Ft. GLA: 27
Directional Distribution: 51% entering, 49% exiting

Vehicle Trip Generation per 1000 Sq. Ft. GLA

Average Rate	Range of Rates	Standard Deviation
6.57	1.88 - 14.23	3.45

Data Plot and Equation

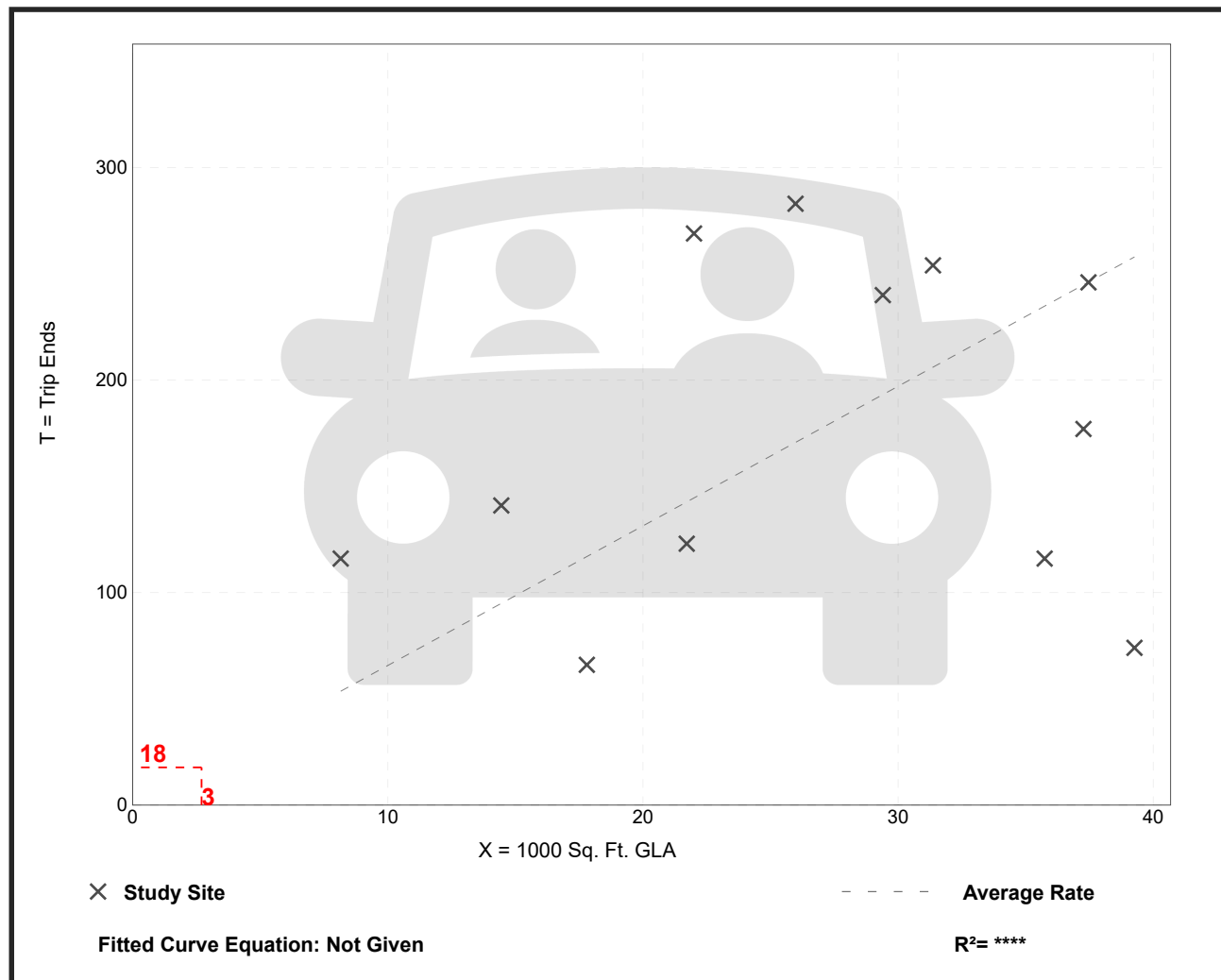

Land Use: 850 Supermarket

Description

A supermarket is a free-standing retail store that sells a complete assortment of food, beverage, food preparation materials, and household products. A supermarket may also provide additional products and services such as a bakery, dry cleaning, floral arrangements, greeting cards, a limited-service bank, and a pharmacy.

Additional Data

In prior editions of *Trip Generation Manual*, a separate land use code was assigned to a discount supermarket. With the addition of new supermarket data points, an examination of the database reveals very little difference between trip generation rates for the traditional supermarket and a reported discount supermarket. This examination looked at both the small discount supermarkets and the large discount supermarkets. As a result, all types of supermarkets are included in this land use database.

The technical appendices provide supporting information on time-of-day distributions for this land use. The appendices can be accessed through either the ITETripGen web app or the trip generation resource page on the ITE website (<https://www.ite.org/technical-resources/topics/trip-and-parking-generation/>).

The sites were surveyed in the 1980s, the 1990s, the 2000s, the 2010s, and the 2020s in Alberta (CAN), California, Colorado, Connecticut, District of Columbia, Florida, Georgia, Illinois, Kentucky, Maryland, Minnesota, Nevada, New Jersey, New York, Ontario (CAN), Oregon, Pennsylvania, South Dakota, Texas, Vermont, Virginia, Washington, and Wisconsin.

Source Numbers

213, 221, 236, 251, 273, 305, 359, 365, 438, 440, 442, 447, 448, 514, 520, 537, 552, 577, 610, 715, 716, 728, 738, 746, 854, 870, 882, 893, 917, 926, 935, 946, 959, 961, 966, 975, 1004, 1009, 1025, 1058, 1063, 1064

Supermarket (850)

Vehicle Trip Ends vs: 1000 Sq. Ft. GFA
On a: Weekday

Setting/Location: General Urban/Suburban
Number of Studies: 22
Avg. 1000 Sq. Ft. GFA: 52
Directional Distribution: 50% entering, 50% exiting

Vehicle Trip Generation per 1000 Sq. Ft. GFA

Average Rate	Range of Rates	Standard Deviation
93.84	30.09 - 170.24	27.05

Data Plot and Equation

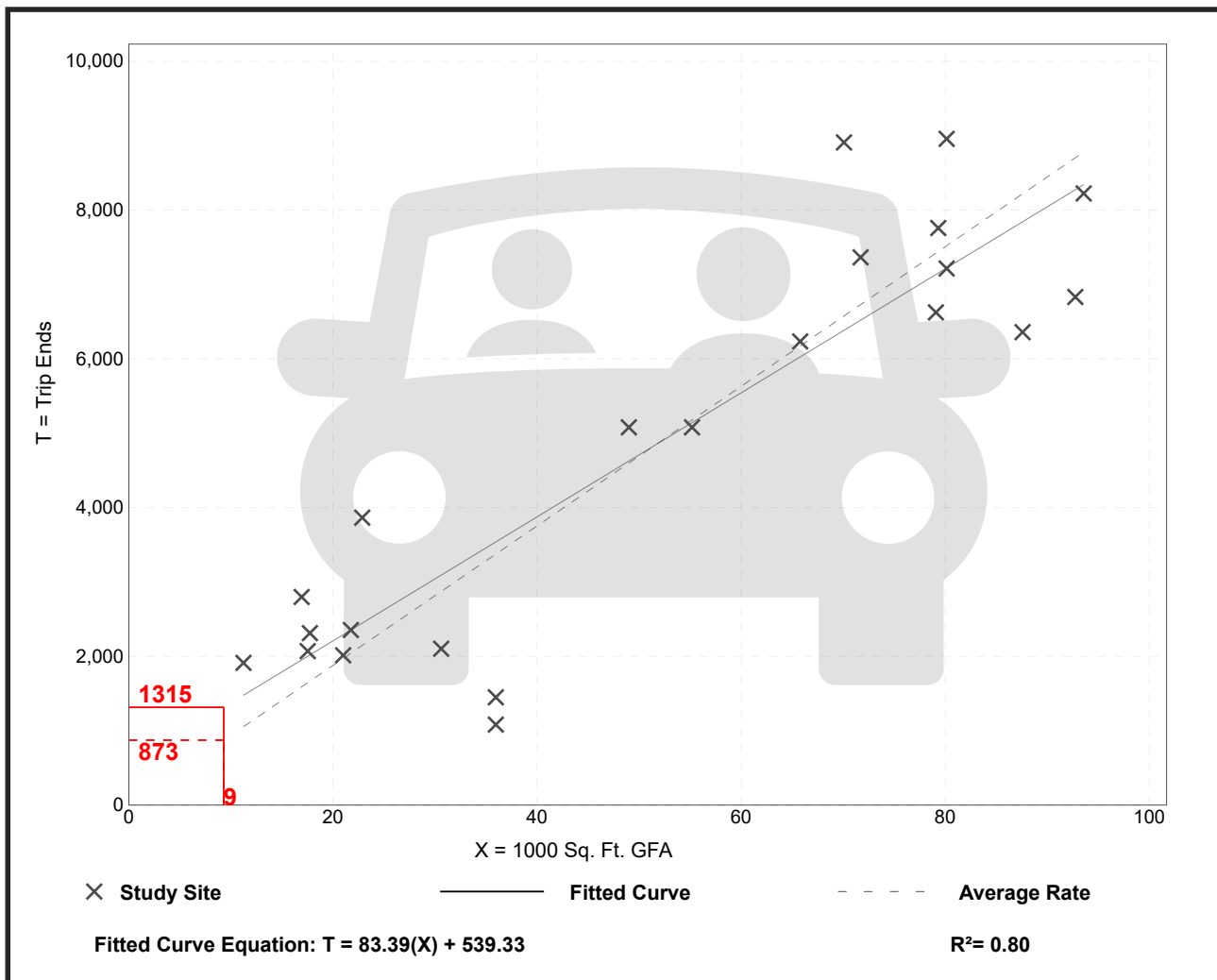

Supermarket (850)

Vehicle Trip Ends vs: 1000 Sq. Ft. GFA
On a: Weekday,
Peak Hour of Adjacent Street Traffic,
One Hour Between 7 and 9 a.m.
Setting/Location: General Urban/Suburban
Number of Studies: 34
Avg. 1000 Sq. Ft. GFA: 61
Directional Distribution: 59% entering, 41% exiting

Vehicle Trip Generation per 1000 Sq. Ft. GFA

Average Rate	Range of Rates	Standard Deviation
2.86	0.89 - 9.35	1.45

Data Plot and Equation

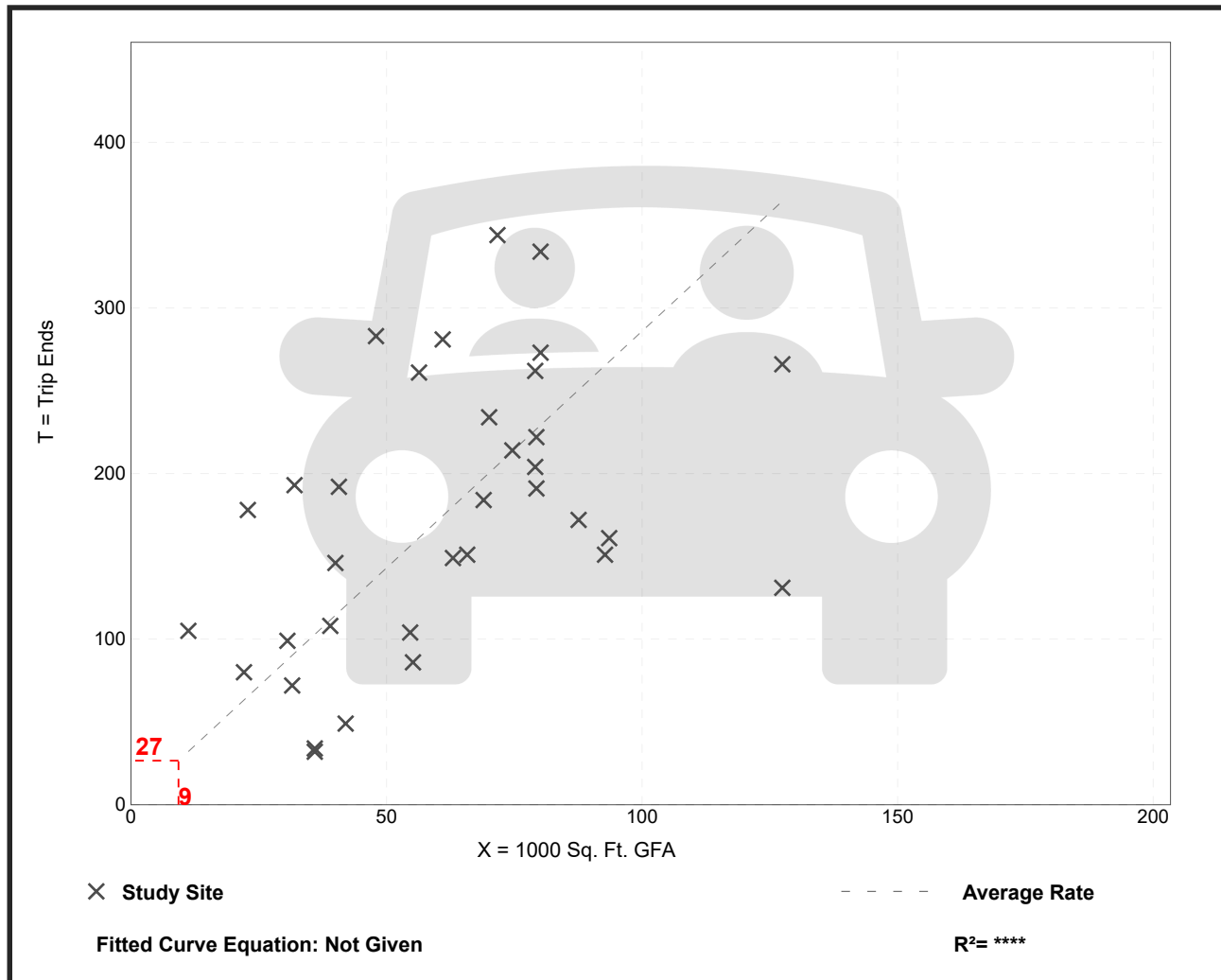

Supermarket (850)

Vehicle Trip Ends vs: 1000 Sq. Ft. GFA
On a: Weekday,
Peak Hour of Adjacent Street Traffic,
One Hour Between 4 and 6 p.m.
Setting/Location: General Urban/Suburban
 Number of Studies: 104
 Avg. 1000 Sq. Ft. GFA: 55
 Directional Distribution: 50% entering, 50% exiting

Vehicle Trip Generation per 1000 Sq. Ft. GFA

Average Rate	Range of Rates	Standard Deviation
8.95	3.11 - 20.30	3.32

Data Plot and Equation

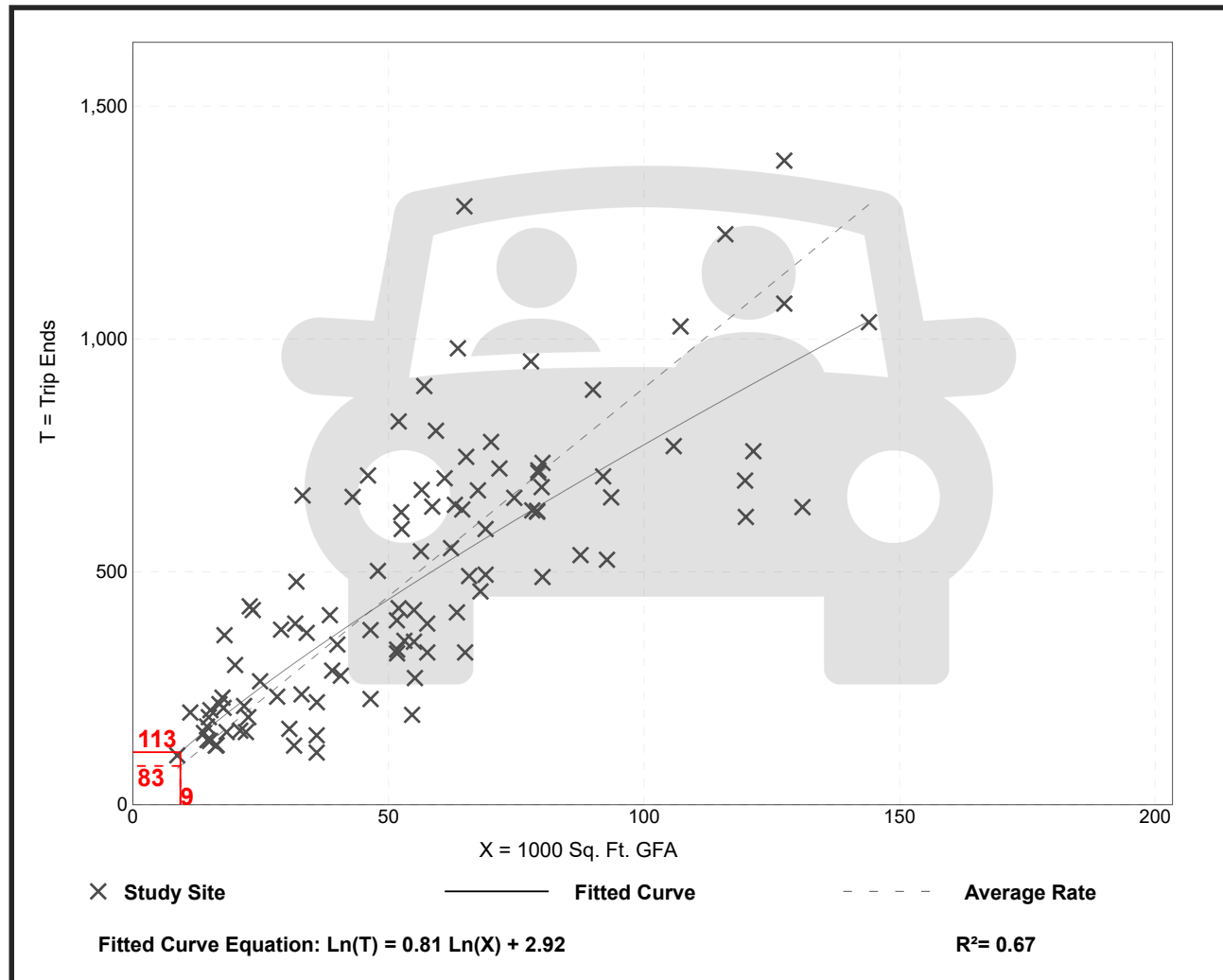

Supermarket (850)

Vehicle Trip Ends vs: 1000 Sq. Ft. GFA
On a: Saturday, Peak Hour of Generator

Setting/Location: General Urban/Suburban
 Number of Studies: 62
 Avg. 1000 Sq. Ft. GFA: 65
 Directional Distribution: 50% entering, 50% exiting

Vehicle Trip Generation per 1000 Sq. Ft. GFA

Average Rate	Range of Rates	Standard Deviation
10.10	5.51 - 22.61	3.30

Data Plot and Equation

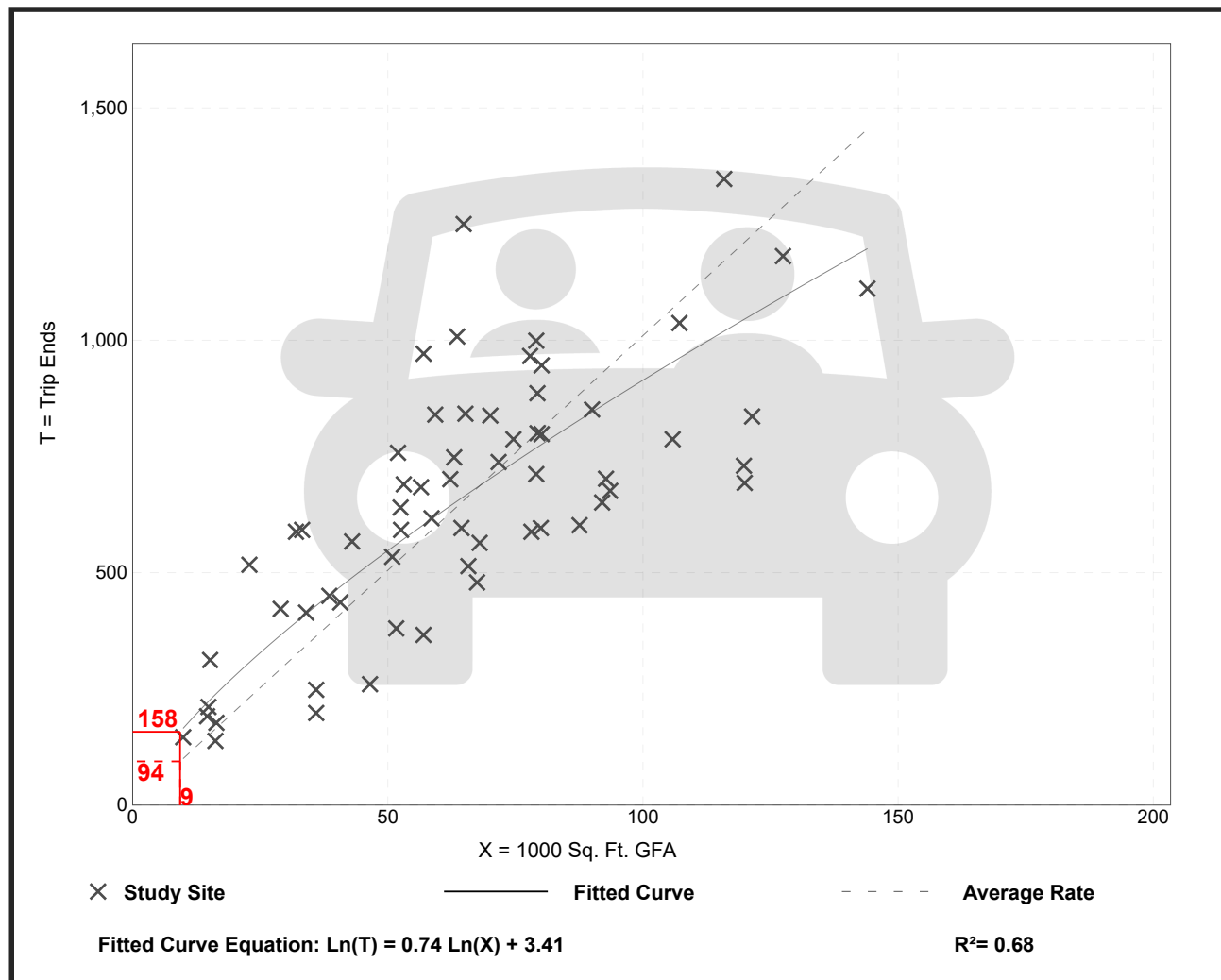

Land Use: 934

Fast-Food Restaurant with Drive-Through Window

Description

This land use includes any fast-food restaurant with a drive-through window. This type of restaurant is characterized by a large drive-through and large carry-out clientele, long hours of service (some are open for breakfast, all are open for lunch and dinner, some are open late at night or 24 hours a day) and high turnover rates for eat-in customers. The restaurant does not provide table service. A patron generally orders from a menu board and pays before receiving the meal. A typical duration of stay for an eat-in patron is less than 30 minutes. Fast casual restaurant (Land Use 930), high-turnover (sit-down) restaurant (Land Use 932), fast-food restaurant without drive-through window (Land Use 933), and fast-food restaurant with drive-through window and no indoor seating (Land Use 935) are related uses.

Additional Data

Users should exercise caution when applying statistics during the AM peak periods, as the sites contained in the database for this land use may or may not be open for breakfast. In cases where it was confirmed that the sites were not open for breakfast, data for the AM peak hour of the adjacent street traffic were removed from the database.

If the restaurant has outdoor seating, its area is not included in the overall gross floor area. For a restaurant that has significant outdoor seating, the number of seats may be more reliable than GFA as an independent variable on which to establish a trip generation rate.

The technical appendices provide supporting information on time-of-day distributions for this land use. The appendices can be accessed through either the ITETripGen web app or the trip generation resource page on the ITE website (<https://www.ite.org/technical-resources/topics/trip-and-parking-generation/>).

The sites were surveyed in the 1980s, the 1990s, the 2000s, and the 2010s in Alaska, Alberta (CAN), California, Colorado, Florida, Indiana, Kentucky, Maryland, Massachusetts, Minnesota, Montana, New Hampshire, New Jersey, New York, North Carolina, Ohio, Pennsylvania, South Dakota, Texas, Vermont, Virginia, Washington, and Wisconsin.

Source Numbers

163, 164, 168, 180, 181, 241, 245, 278, 294, 300, 301, 319, 338, 340, 342, 358, 389, 438, 502, 552, 577, 583, 584, 617, 640, 641, 704, 715, 728, 810, 866, 867, 869, 885, 886, 927, 935, 962, 977, 1050, 1053, 1054

Fast-Food Restaurant with Drive-Through Window (934)

Vehicle Trip Ends vs: 1000 Sq. Ft. GFA
On a: Weekday

Setting/Location: General Urban/Suburban
Number of Studies: 71
Avg. 1000 Sq. Ft. GFA: 3
Directional Distribution: 50% entering, 50% exiting

Vehicle Trip Generation per 1000 Sq. Ft. GFA

Average Rate	Range of Rates	Standard Deviation
467.48	98.89 - 1137.66	238.62

Data Plot and Equation

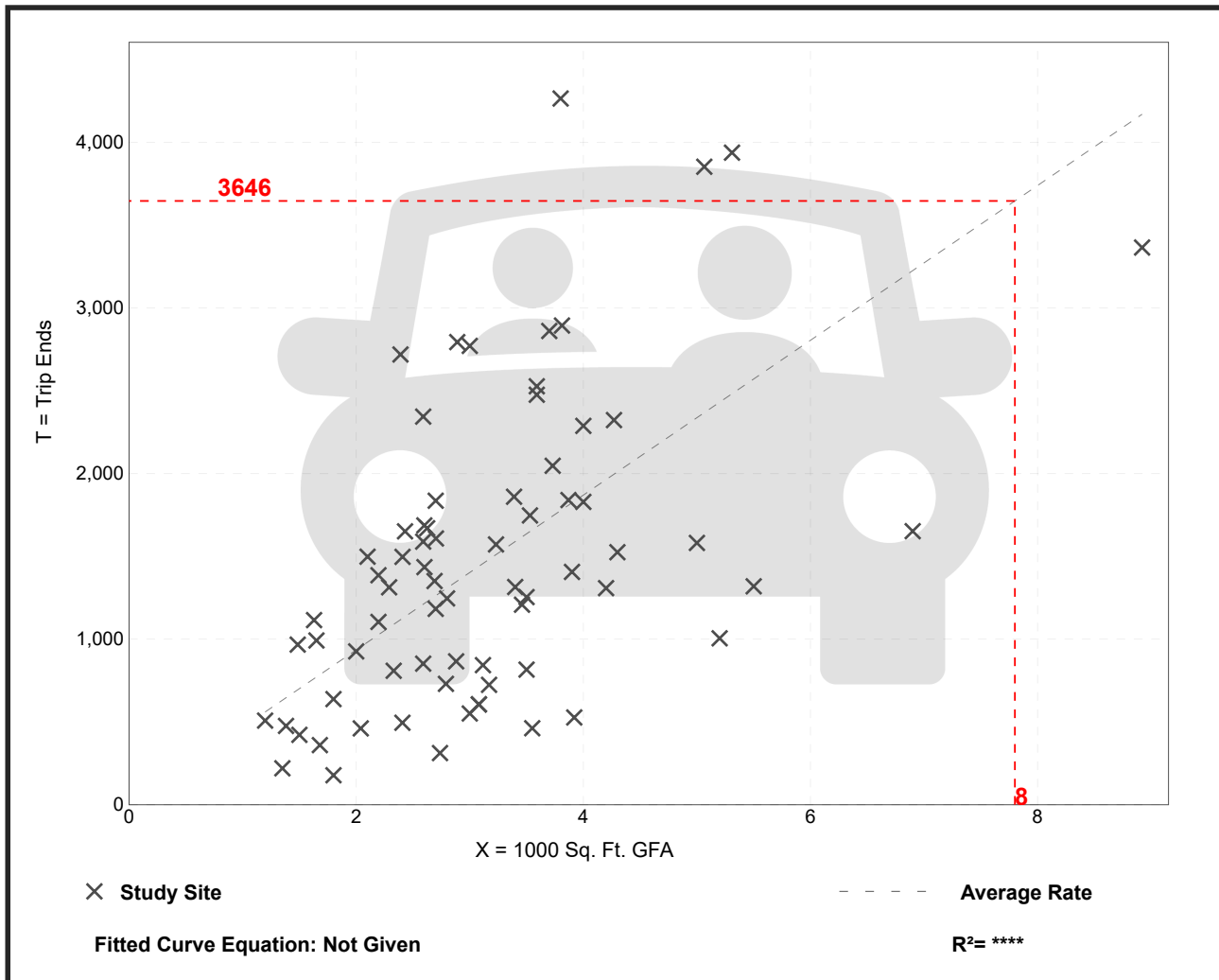

Fast-Food Restaurant with Drive-Through Window (934)

Vehicle Trip Ends vs: 1000 Sq. Ft. GFA
 On a: Weekday,
 Peak Hour of Adjacent Street Traffic,
 One Hour Between 7 and 9 a.m.
 Setting/Location: General Urban/Suburban
 Number of Studies: 96
 Avg. 1000 Sq. Ft. GFA: 4
 Directional Distribution: 51% entering, 49% exiting

Vehicle Trip Generation per 1000 Sq. Ft. GFA

Average Rate	Range of Rates	Standard Deviation
44.61	1.05 - 164.25	27.14

Data Plot and Equation

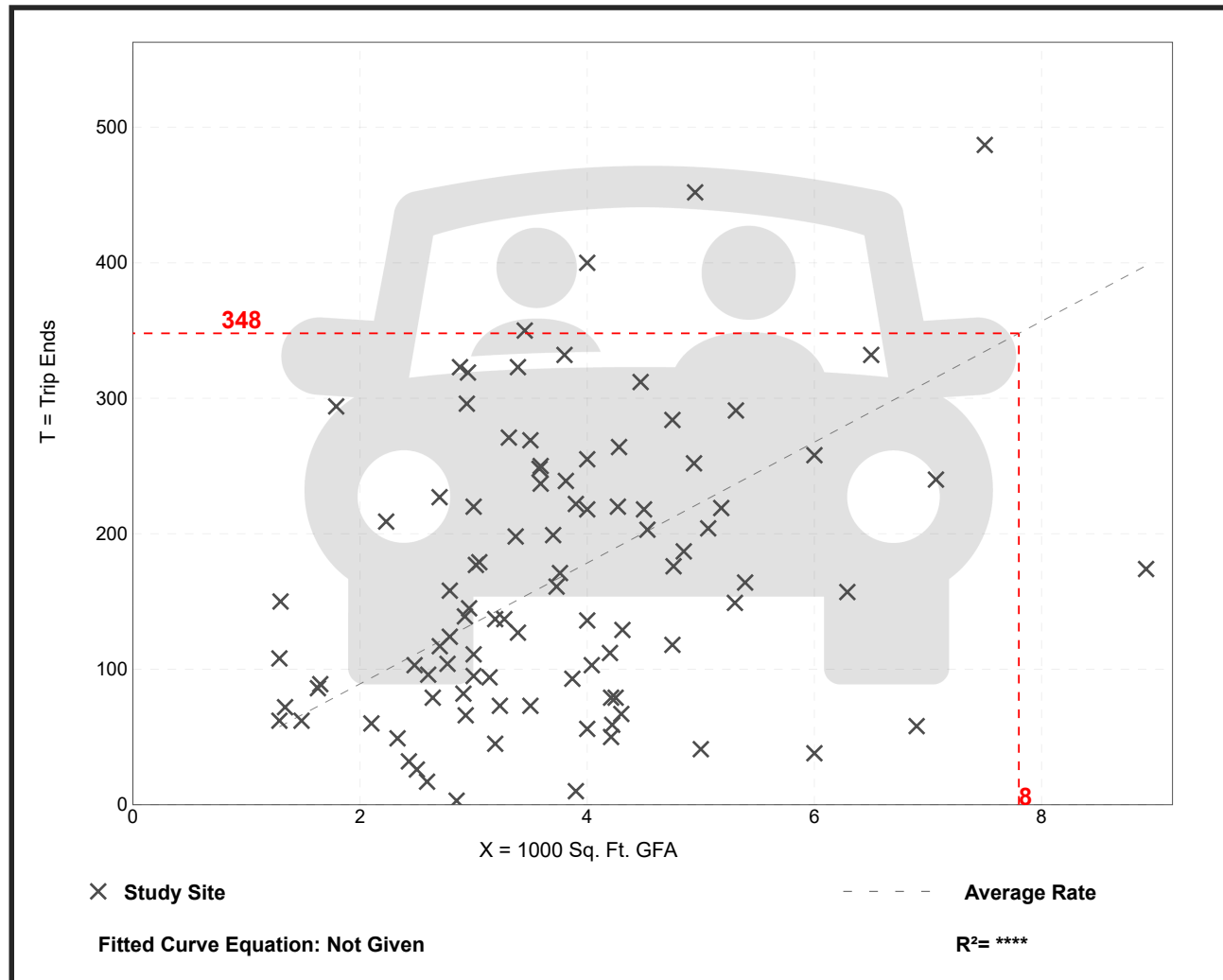

Fast-Food Restaurant with Drive-Through Window (934)

Vehicle Trip Ends vs: 1000 Sq. Ft. GFA
 On a: Weekday,
 Peak Hour of Adjacent Street Traffic,
 One Hour Between 4 and 6 p.m.
 Setting/Location: General Urban/Suburban
 Number of Studies: 190
 Avg. 1000 Sq. Ft. GFA: 3
 Directional Distribution: 52% entering, 48% exiting

Vehicle Trip Generation per 1000 Sq. Ft. GFA

Average Rate	Range of Rates	Standard Deviation
33.03	8.77 - 117.22	17.59

Data Plot and Equation

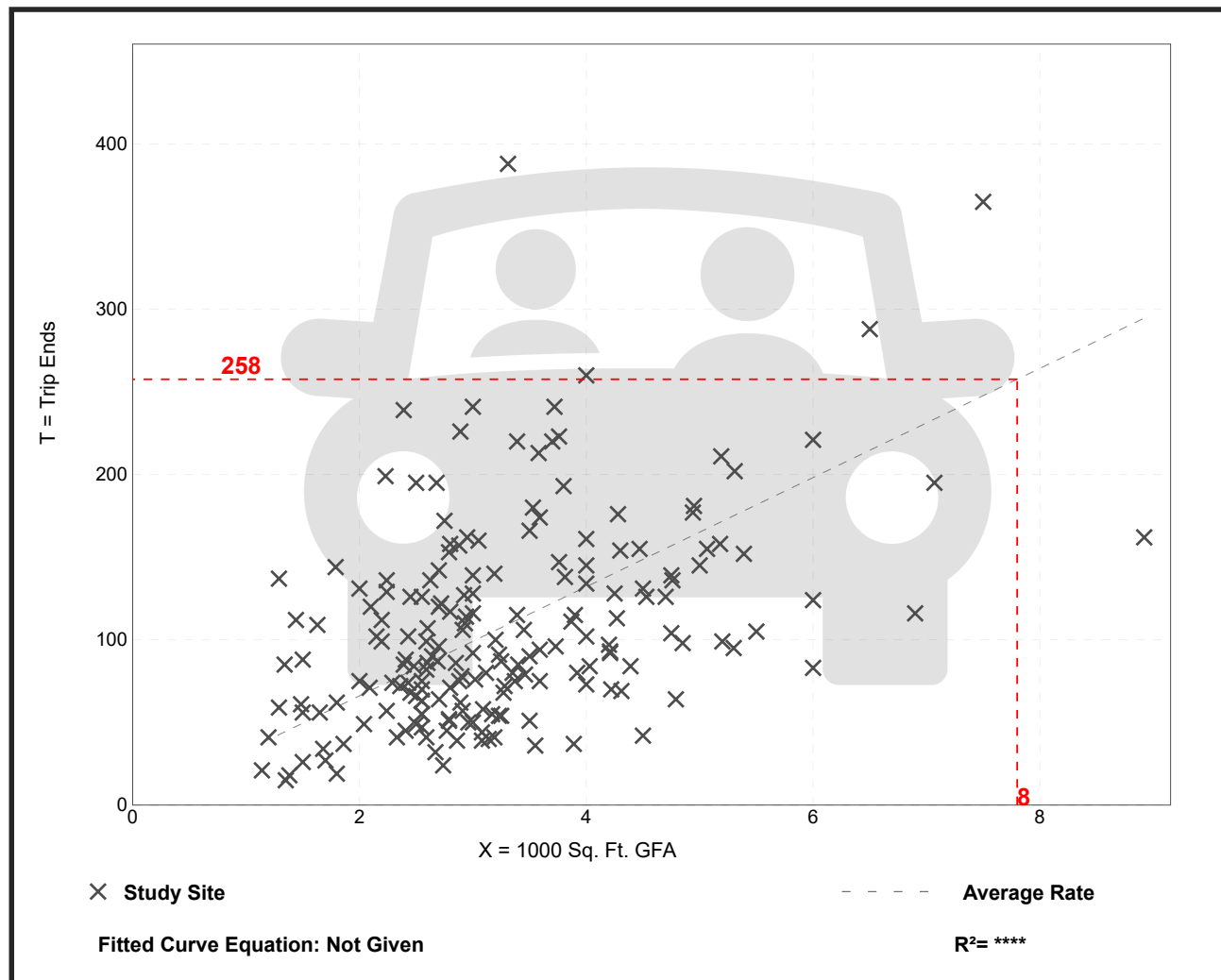

Fast-Food Restaurant with Drive-Through Window (934)

Vehicle Trip Ends vs: 1000 Sq. Ft. GFA
On a: Saturday, Peak Hour of Generator

Setting/Location: General Urban/Suburban
Number of Studies: 53
Avg. 1000 Sq. Ft. GFA: 4
Directional Distribution: 51% entering, 49% exiting

Vehicle Trip Generation per 1000 Sq. Ft. GFA

Average Rate	Range of Rates	Standard Deviation
55.25	11.25 - 122.92	24.62

Data Plot and Equation

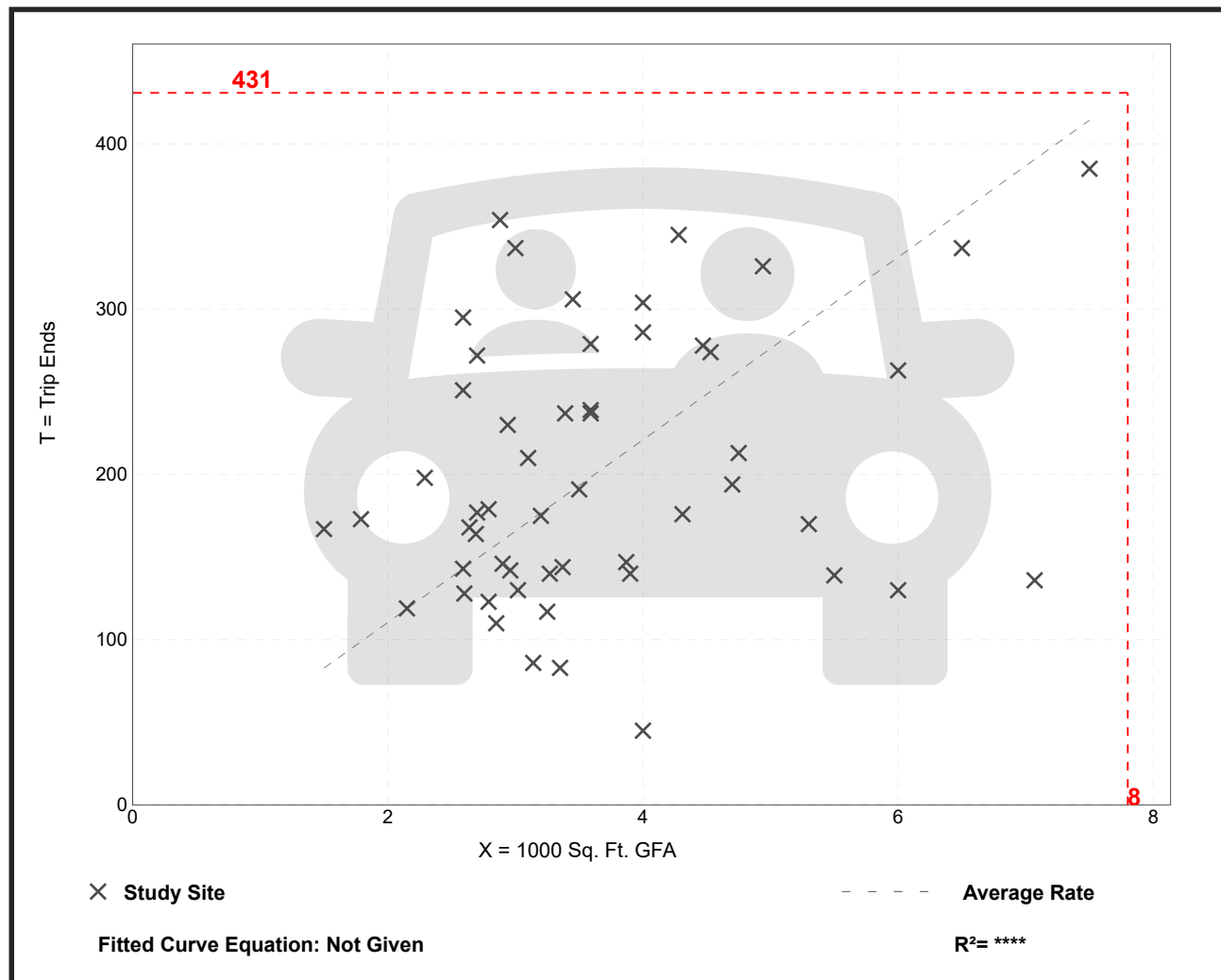

Land Use: 937

Coffee/Donut Shop with Drive-Through Window

Description

This land use includes any coffee and donut restaurant that has a drive-through window as well as a walk-in entrance area at which a patron can purchase and consume items. The restaurant sells freshly brewed coffee (along with coffee-related accessories) and a variety of food/drink products such as donuts, bagels, breads, muffins, cakes, sandwiches, wraps, salads, and other hot and cold beverages. The restaurant marketing and sales may emphasize coffee beverages over food (or vice versa).

A coffee/donut shop typically holds long store hours (more than 15 hours) with an early morning opening. Limited indoor seating is generally provided for patrons, but table service is not provided.

Coffee/donut shop without drive-through window (Land Use 936) and coffee/donut shop with drive-through window and no indoor seating (Land Use 938) are related uses.

Additional Data

The sites were surveyed in the 1990s, the 2000s, and the 2010s in California, Colorado, Connecticut, Illinois, Massachusetts, Minnesota, Nevada, New Hampshire, New Jersey, New York, Ontario (CAN), Pennsylvania, Quebec (CAN), Tennessee, Vermont, Washington, and Wisconsin.

Specialized Land Use Data

One study was conducted during the pandemic in 2020. Twelve sites were counted in Illinois and Missouri during the AM and PM adjacent street peak hours. The data have not been incorporated within the overall ITE trip generation database and are not reflected in the data plots for this land use. Consideration for their inclusion will be given for the 12th Edition of *Trip Generation Manual* after additional post-pandemic data are collected. Overall, the pandemic counts yielded an AM adjacent street peak weighted average rate of 84 vehicle trips per 1,000 square feet GFA, roughly equivalent to the pre-pandemic average. The PM adjacent street peak rate was 56 (roughly 40 percent higher than the pre-pandemic value). The higher PM peak rate for these coffee/donut shops conforms with anecdotal observations that with the temporary or permanent closures of many restaurants during the pandemic, the drive-through restaurants that were open did a brisk business even during their off-peak periods.

Source Numbers

594, 599, 615, 617, 618, 621, 622, 635, 639, 712, 714, 725, 726, 728, 853, 854, 892, 903, 928, 959, 979, 982, 1004, 1042, 1044

Coffee/Donut Shop with Drive-Through Window (937)

Vehicle Trip Ends vs: 1000 Sq. Ft. GFA
On a: Weekday

Setting/Location: General Urban/Suburban
Number of Studies: 6
Avg. 1000 Sq. Ft. GFA: 2
Directional Distribution: 50% entering, 50% exiting

Vehicle Trip Generation per 1000 Sq. Ft. GFA

Average Rate	Range of Rates	Standard Deviation
533.57	309.41 - 869.00	243.65

Data Plot and Equation

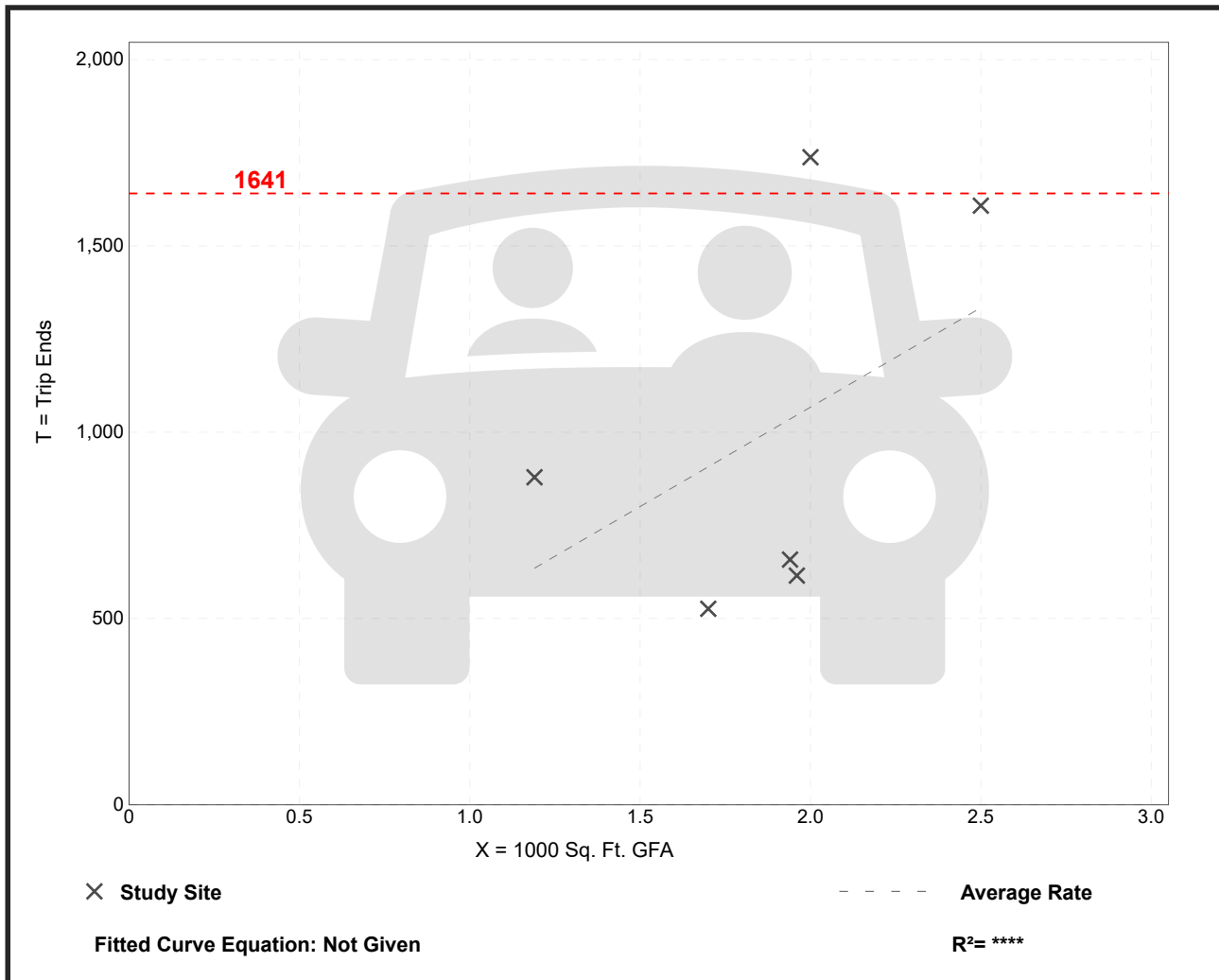

Coffee/Donut Shop with Drive-Through Window (937)

Vehicle Trip Ends vs: 1000 Sq. Ft. GFA
 On a: Weekday,
 Peak Hour of Adjacent Street Traffic,
 One Hour Between 7 and 9 a.m.
 Setting/Location: General Urban/Suburban
 Number of Studies: 78
 Avg. 1000 Sq. Ft. GFA: 2
 Directional Distribution: 51% entering, 49% exiting

Vehicle Trip Generation per 1000 Sq. Ft. GFA

Average Rate	Range of Rates	Standard Deviation
85.88	18.51 - 282.05	44.92

Data Plot and Equation

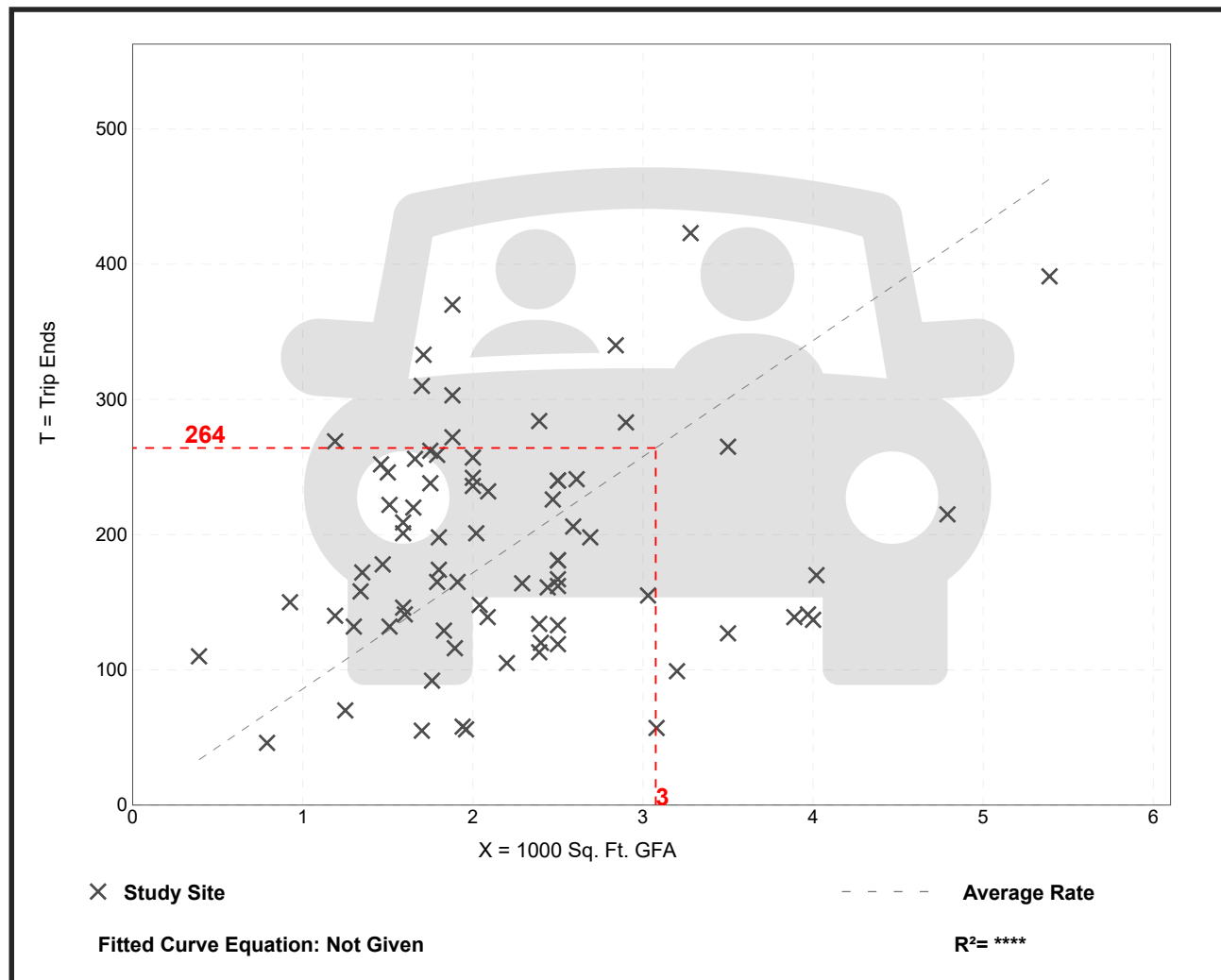

Coffee/Donut Shop with Drive-Through Window (937)

Vehicle Trip Ends vs: 1000 Sq. Ft. GFA
 On a: Weekday,
 Peak Hour of Adjacent Street Traffic,
 One Hour Between 4 and 6 p.m.
 Setting/Location: General Urban/Suburban
 Number of Studies: 36
 Avg. 1000 Sq. Ft. GFA: 2
 Directional Distribution: 50% entering, 50% exiting

Vehicle Trip Generation per 1000 Sq. Ft. GFA

Average Rate	Range of Rates	Standard Deviation
38.99	13.78 - 92.31	17.79

Data Plot and Equation

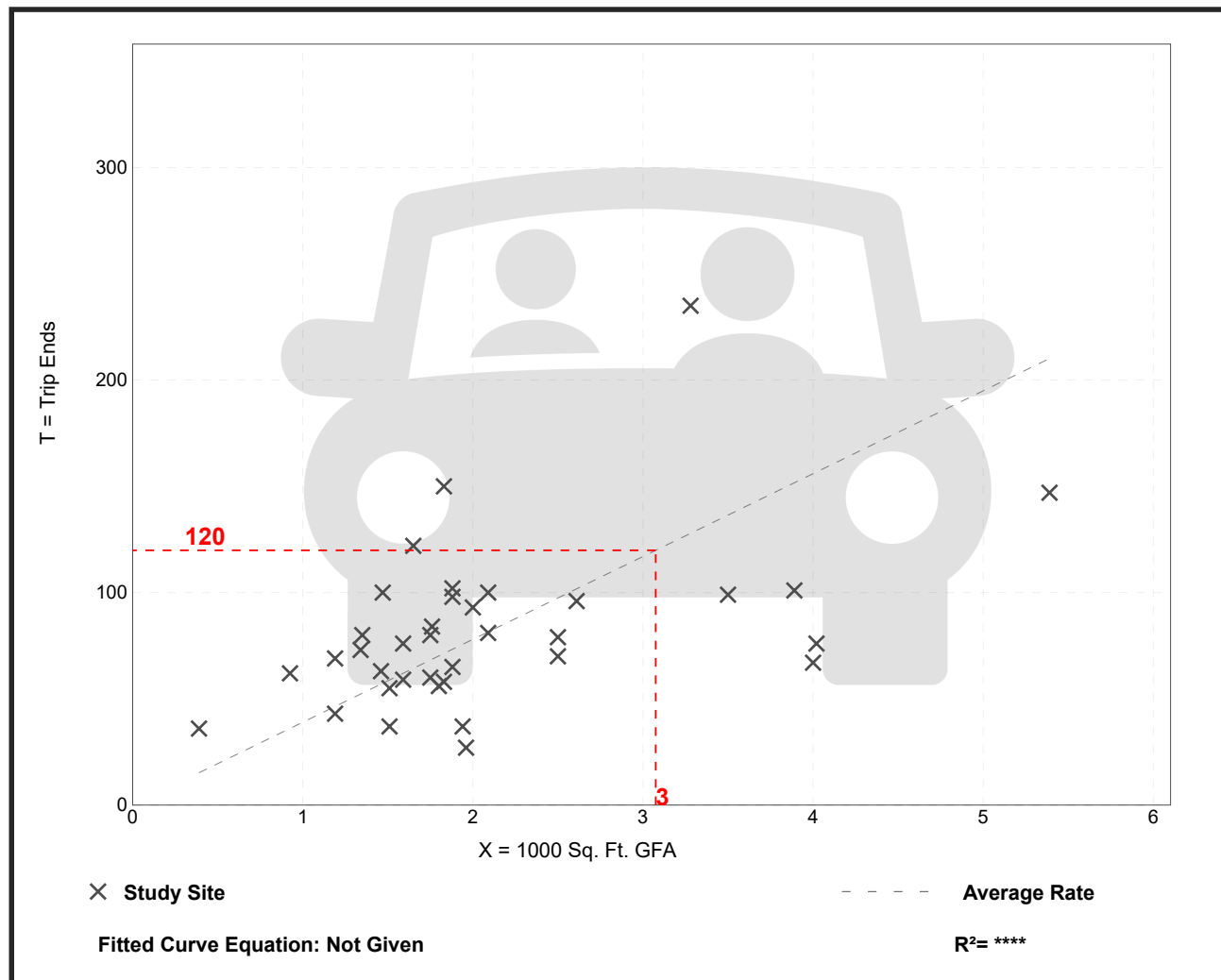

Coffee/Donut Shop with Drive-Through Window (937)

Vehicle Trip Ends vs: 1000 Sq. Ft. GFA
On a: Saturday, Peak Hour of Generator

Setting/Location: General Urban/Suburban
Number of Studies: 9
Avg. 1000 Sq. Ft. GFA: 2
Directional Distribution: 50% entering, 50% exiting

Vehicle Trip Generation per 1000 Sq. Ft. GFA

Average Rate	Range of Rates	Standard Deviation
87.91	48.42 - 138.28	34.34

Data Plot and Equation

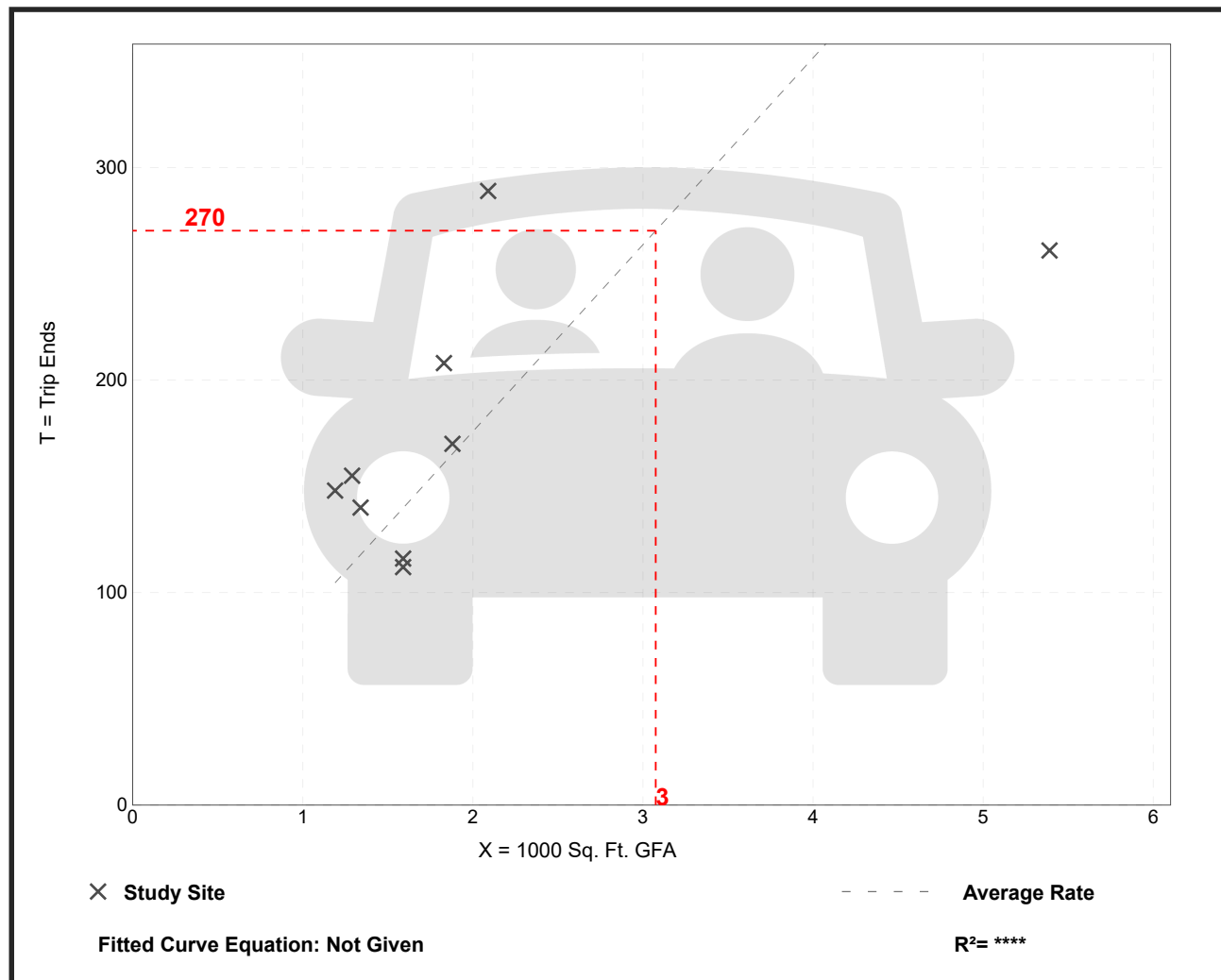

Land Use: 945

Convenience Store/Gas Station

Description

A convenience store/gas station is a facility with a co-located convenience store and gas station. The convenience store sells grocery and other everyday items that a person may need or want as a matter of convenience. The gas station sells automotive fuels such as gasoline and diesel.

A convenience store/gas station is typically located along a major thoroughfare to optimize motorist convenience. Extended hours of operation (with many open 24 hours, 7 days a week) are common at these facilities.

The convenience store product mix typically includes pre-packaged grocery items, beverages, dairy products, snack foods, confectionary, tobacco products, over-the-counter drugs, and toiletries. A convenience store may sell alcohol, often limited to beer and wine. Coffee and pre-made sandwiches are also commonly sold at a convenience store. Made-to-order food orders are sometimes offered. Some stores offer limited seating.

The sites in this land use include both self-pump and attendant-pumped fueling positions and both pre-pay and post-pay operations.

Convenience store (Land Use 851), gasoline/service station (Land Use 944), and truck stop (Land Use 950) are related uses.

Land Use Subcategory

Multiple subcategories were added to this land use to allow for multi-variable evaluation of sites with single-variable data plots. All study sites are assigned to one of three subcategories, based on the number of vehicle fueling positions (VFP) at the site: between 2 and 8 VFP, between 9 and 15 VFP, and between 16 and 24 VFP. For each VFP range subcategory, data plots are presented with GFA as the independent variable for all time periods and trip types for which data are available. The use of both GFA and VFP (as the independent variable and land use subcategory, respectively) provides a significant improvement in the reliability of a trip generation estimate when compared to the single-variable data plots in prior editions of *Trip Generation Manual*.

Further, the study sites were also assigned to one of three other subcategories, based on the gross floor area (GFA) of the convenience store at the site: between 2,000 and 4,000 square feet, between 4,000 and 5,500 square feet, and between 5,500 and 10,000 square feet. For each GFA subcategory range, data plots are presented with VFP as the independent variable for all time periods and trip types for which data are available. The use of both VFP and GFA (as the independent variable and land use subcategory, respectively) provides a significant improvement in the reliability of a trip generation estimate when compared to the single-variable data plots in prior editions of *Trip Generation Manual*.

When analyzing the convenience store/gas station land use with each combination of GFA and VFP values as described above, the two sets of data plots will produce two estimates of site-generated trips. Both values can be considered when determining a site trip generation estimate.

Data plots are also provided for three additional independent variables: AM peak hour traffic on adjacent street, PM peak hour traffic on adjacent street, and employees. These independent variables are intended to be analyzed as single independent variables and do not have sub-categories associated with them. Within the data plots and within the ITETripGen web app, these plots are found under the land use subcategory “none.”

Additional Data

ITE recognizes there are existing convenience store/gas station sites throughout North America that are larger than the sites presented in the data plots. However, the ITE database does not include any site with more than 24 VFP or any site with gross floor area greater than 10,000 square feet. Submission of trip generation data for larger sites is encouraged.

The technical appendices provide supporting information on time-of-day distributions for this land use. The appendices can be accessed through either the ITETripGen web app or the trip generation resource page on the ITE website (<https://www.ite.org/technical-resources/topics/trip-and-parking-generation/>).

The sites were surveyed in the 1980s, the 1990s, the 2000s, and the 2010s in Alberta (CAN), Arkansas, California, Connecticut, Delaware, Florida, Indiana, Iowa, Kentucky, Maryland, Massachusetts, Minnesota, Nevada, New Hampshire, New Jersey, Pennsylvania, Rhode Island, South Dakota, Texas, Utah, Vermont, Washington, and Wisconsin.

Source Numbers

221, 245, 274, 288, 300, 340, 350, 351, 352, 355, 359, 385, 440, 617, 718, 810, 813, 844, 850, 853, 864, 865, 867, 869, 882, 883, 888, 904, 926, 927, 936, 938, 954, 960, 962, 977, 1004, 1024, 1025, 1027, 1052

Convenience Store/Gas Station - GFA (4-5.5k) (945)

Vehicle Trip Ends vs: Vehicle Fueling Positions
On a: Weekday

Setting/Location: General Urban/Suburban
Number of Studies: 5
Avg. Num. of Vehicle Fueling Positions: 14
Directional Distribution: 50% entering, 50% exiting

Vehicle Trip Generation per Vehicle Fueling Position

Average Rate	Range of Rates	Standard Deviation
257.13	193.00 - 324.17	57.53

Data Plot and Equation

Caution – Small Sample Size

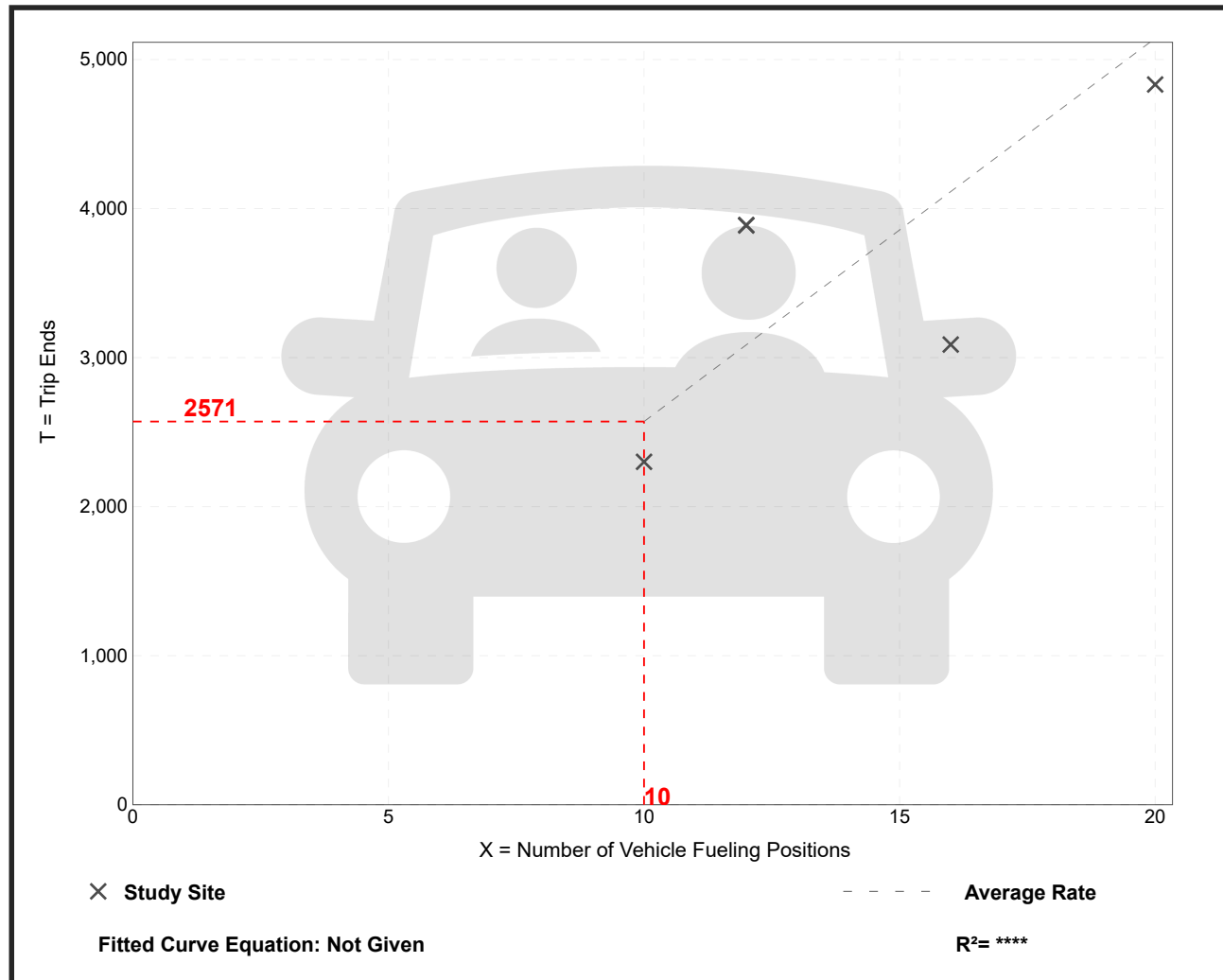

Convenience Store/Gas Station - GFA (4-5.5k) (945)

Vehicle Trip Ends vs: Vehicle Fueling Positions

**On a: Weekday,
Peak Hour of Adjacent Street Traffic,
One Hour Between 7 and 9 a.m.**

Setting/Location: General Urban/Suburban

Number of Studies: 18

Avg. Num. of Vehicle Fueling Positions: 13

Directional Distribution: 50% entering, 50% exiting

Vehicle Trip Generation per Vehicle Fueling Position

Average Rate	Range of Rates	Standard Deviation
27.04	7.78 - 44.38	9.88

Data Plot and Equation

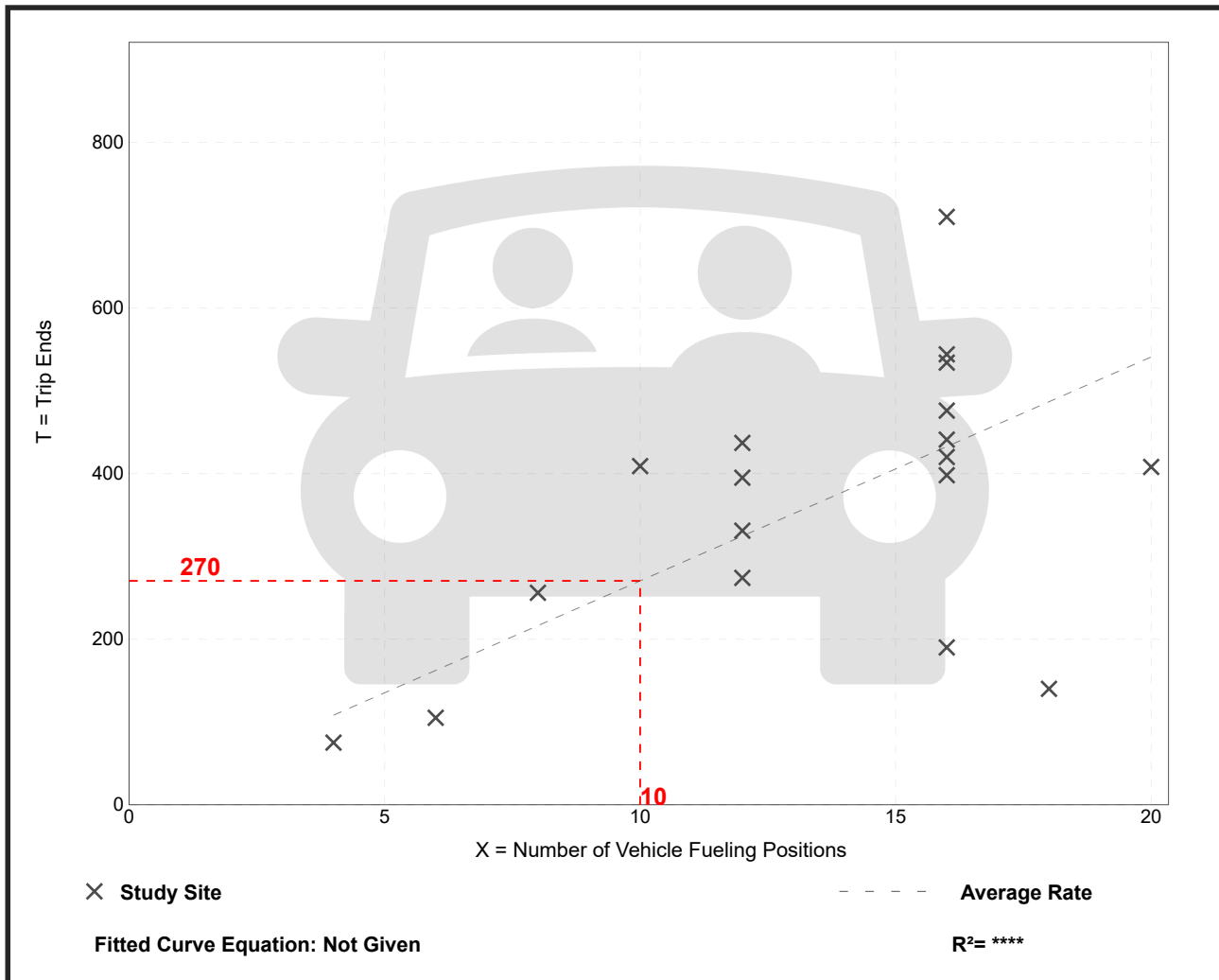

Convenience Store/Gas Station - GFA (4-5.5k) (945)

Vehicle Trip Ends vs: Vehicle Fueling Positions

**On a: Weekday,
Peak Hour of Adjacent Street Traffic,
One Hour Between 4 and 6 p.m.**

Setting/Location: General Urban/Suburban

Number of Studies: 23

Avg. Num. of Vehicle Fueling Positions: 14

Directional Distribution: 50% entering, 50% exiting

Vehicle Trip Generation per Vehicle Fueling Position

Average Rate	Range of Rates	Standard Deviation
22.76	9.78 - 37.50	8.49

Data Plot and Equation

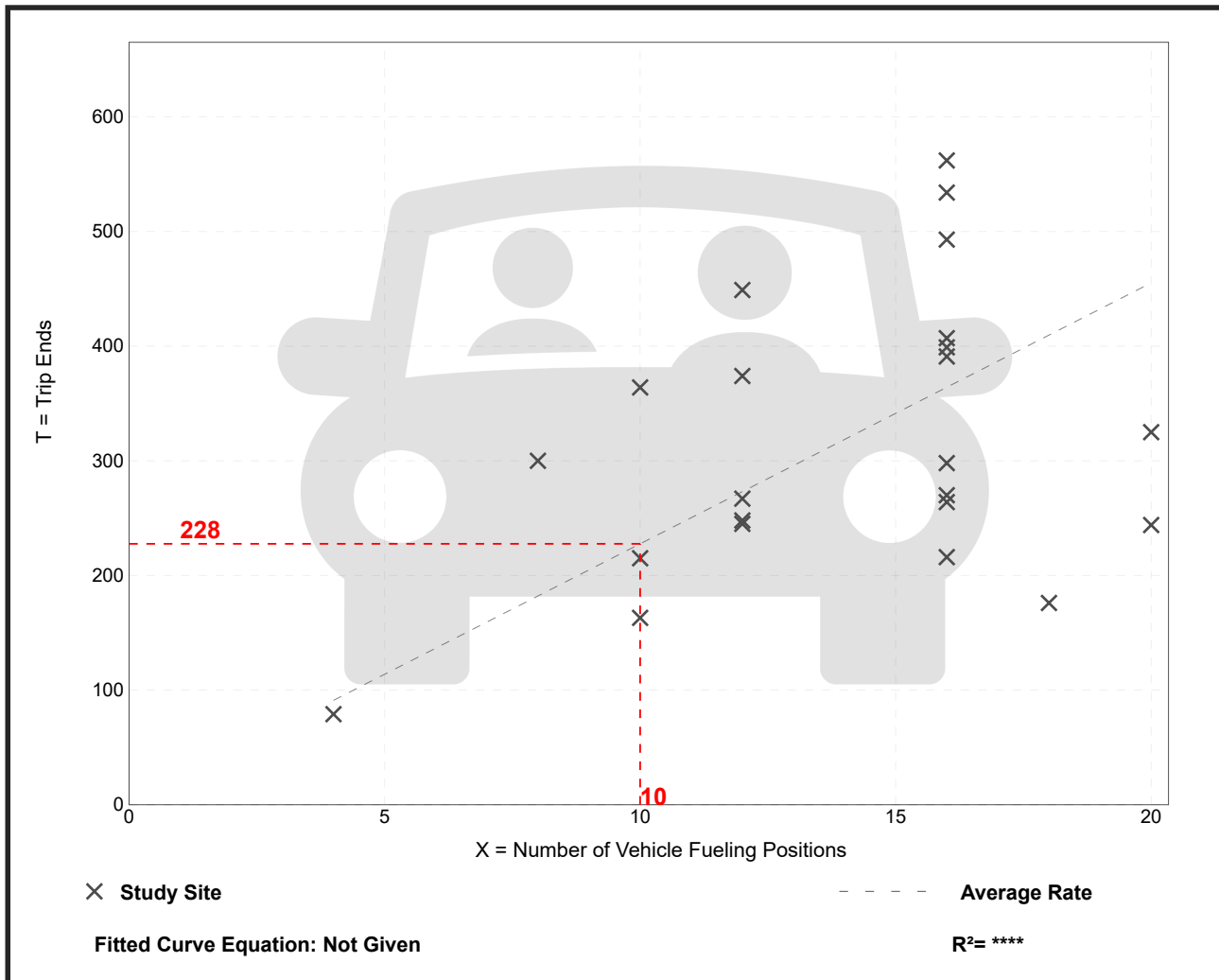

Convenience Store/Gas Station - GFA (4-5.5k) (945)

Vehicle Trip Ends vs: Vehicle Fueling Positions
On a: Saturday, Peak Hour of Generator

Setting/Location: General Urban/Suburban
Number of Studies: 7
Avg. Num. of Vehicle Fueling Positions: 14
Directional Distribution: 51% entering, 49% exiting

Vehicle Trip Generation per Vehicle Fueling Position

Average Rate	Range of Rates	Standard Deviation
20.44	10.94 - 33.17	8.08

Data Plot and Equation

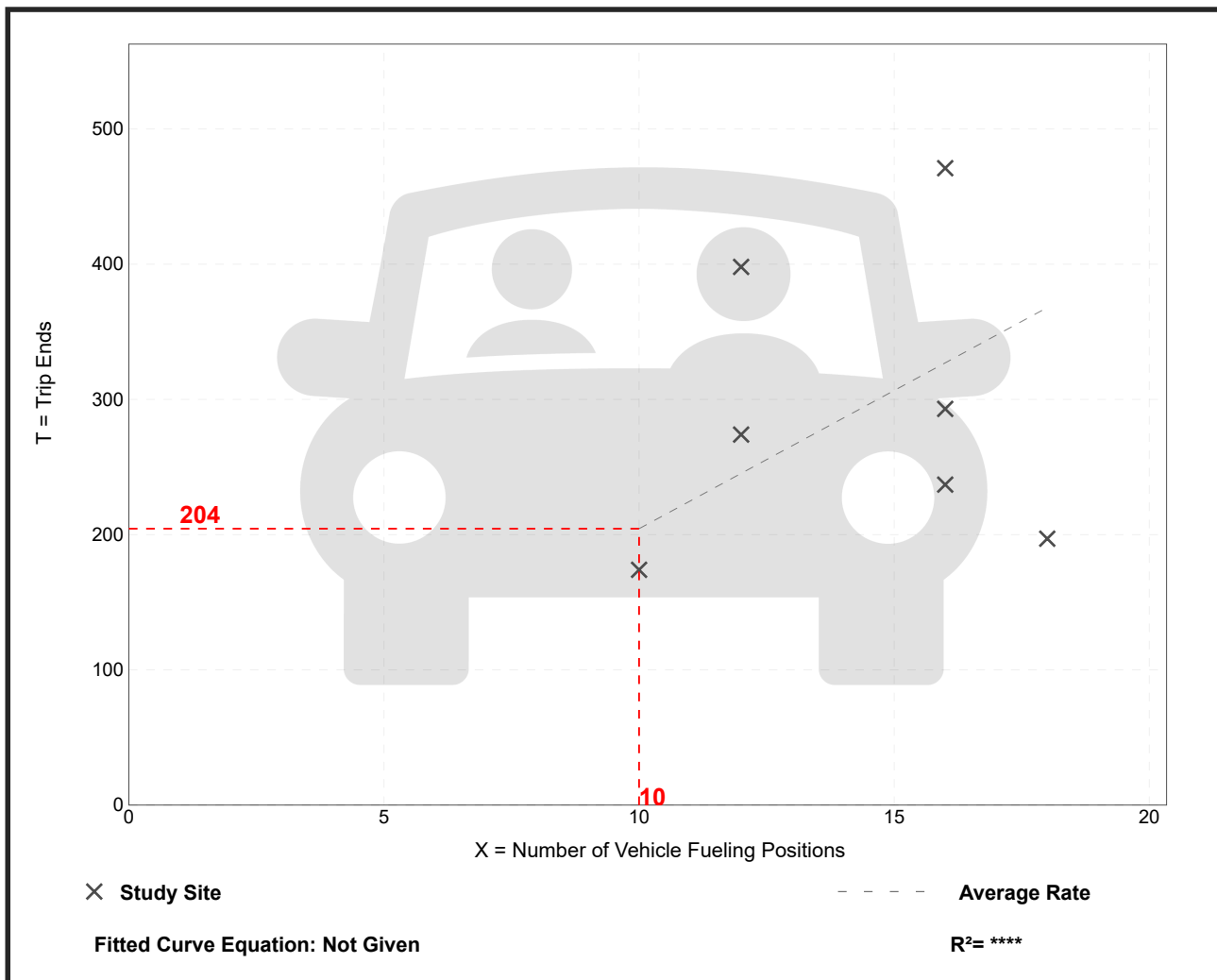

Appendix E: Synchro Reports

Queues
1: Ward Road & Oldham Parkway

Existing Conditions Traffic Volumes
AM Peak Hour



Lane Group	EBL	EBT	WBT	NBL	NBT	SBL	SBT	SBR
Lane Group Flow (vph)	38	31	194	15	612	131	256	63
v/c Ratio	0.40	0.14	0.60	0.10	0.33	0.52	0.10	0.05
Control Delay (s/veh)	45.0	22.4	18.1	35.5	12.7	38.7	5.3	0.4
Queue Delay	0.0	0.0	0.0	0.0	0.0	0.0	0.0	0.0
Total Delay (s/veh)	45.0	22.4	18.1	35.5	12.7	38.7	5.3	0.4
Queue Length 50th (ft)	18	8	21	7	84	61	14	0
Queue Length 95th (ft)	45	30	77	25	152	108	53	4
Internal Link Dist (ft)		116	246		459		353	
Turn Bay Length (ft)				110		105		
Base Capacity (vph)	137	314	403	316	1901	260	2485	1147
Starvation Cap Reductn	0	0	0	0	0	0	0	0
Spillback Cap Reductn	0	0	0	0	0	0	0	0
Storage Cap Reductn	0	0	0	0	0	0	0	0
Reduced v/c Ratio	0.28	0.10	0.48	0.05	0.32	0.50	0.10	0.05
Intersection Summary								

HCM 7th Signalized Intersection Summary
1: Ward Road & Oldham Parkway

Existing Conditions Traffic Volumes
AM Peak Hour

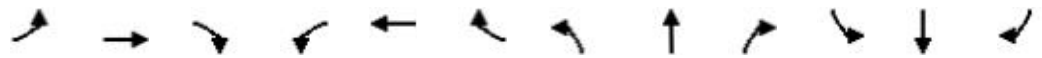











Movement	EBL	EBT	EBR	WBL	WBT	WBR	NBL	NBT	NBR	SBL	SBT	SBR
Lane Configurations	↖	↗			↕		↖	↕		↖	↕	↗
Traffic Volume (veh/h)	35	17	12	14	28	139	14	556	13	122	238	59
Future Volume (veh/h)	35	17	12	14	28	139	14	556	13	122	238	59
Initial Q (Qb), veh	0	0	0	0	0	0	0	0	0	0	0	0
Lane Width Adj.	1.00	1.00	1.00	1.00	1.00	1.00	1.00	1.00	1.00	1.00	1.00	1.00
Ped-Bike Adj(A_pbT)	1.00		1.00	1.00		1.00	1.00		1.00	1.00		1.00
Parking Bus, Adj	1.00	1.00	1.00	1.00	1.00	1.00	1.00	1.00	1.00	1.00	1.00	1.00
Work Zone On Approach		No			No			No			No	
Adj Sat Flow, veh/h/ln	1870	1870	1870	1870	1870	1870	1870	1870	1870	1870	1870	1870
Adj Flow Rate, veh/h	38	18	13	15	30	149	15	598	14	131	256	63
Peak Hour Factor	0.93	0.93	0.93	0.93	0.93	0.93	0.93	0.93	0.93	0.93	0.93	0.93
Percent Heavy Veh, %	2	2	2	2	2	2	2	2	2	2	2	2
Cap, veh/h	213	145	105	58	45	179	32	1936	45	164	2203	983
Arrive On Green	0.14	0.14	0.14	0.14	0.14	0.14	0.02	0.55	0.55	0.09	0.62	0.62
Sat Flow, veh/h	1205	1010	729	65	311	1246	1781	3549	83	1781	3554	1585
Grp Volume(v), veh/h	38	0	31	194	0	0	15	299	313	131	256	63
Grp Sat Flow(s),veh/h/ln	1205	0	1739	1623	0	0	1781	1777	1855	1781	1777	1585
Q Serve(g_s), s	0.0	0.0	1.2	3.8	0.0	0.0	0.7	7.4	7.4	5.8	2.4	1.3
Cycle Q Clear(g_c), s	3.5	0.0	1.2	9.3	0.0	0.0	0.7	7.4	7.4	5.8	2.4	1.3
Prop In Lane	1.00		0.42	0.08		0.77	1.00		0.04	1.00		1.00
Lane Grp Cap(c), veh/h	213	0	250	281	0	0	32	969	1012	164	2203	983
V/C Ratio(X)	0.18	0.00	0.12	0.69	0.00	0.00	0.48	0.31	0.31	0.80	0.12	0.06
Avail Cap(c_a), veh/h	249	0	302	330	0	0	318	969	1012	207	2203	983
HCM Platoon Ratio	1.00	1.00	1.00	1.00	1.00	1.00	1.00	1.00	1.00	1.00	1.00	1.00
Upstream Filter(I)	1.00	0.00	1.00	1.00	0.00	0.00	1.00	1.00	1.00	1.00	1.00	1.00
Uniform Delay (d), s/veh	30.9	0.0	29.9	33.3	0.0	0.0	38.9	9.9	9.9	35.6	6.2	6.0
Incr Delay (d2), s/veh	0.4	0.0	0.2	4.9	0.0	0.0	10.7	0.8	0.8	15.6	0.1	0.1
Initial Q Delay(d3), s/veh	0.0	0.0	0.0	0.0	0.0	0.0	0.0	0.0	0.0	0.0	0.0	0.0
%ile BackOfQ(95%),veh/ln	1.2	0.0	1.0	7.0	0.0	0.0	0.7	4.9	5.1	5.6	1.4	0.7
Unsig. Movement Delay, s/veh												
LnGrp Delay(d), s/veh	31.3	0.0	30.1	38.1	0.0	0.0	49.6	10.8	10.7	51.1	6.3	6.1
LnGrp LOS	C		C	D			D	B	B	D	A	A
Approach Vol, veh/h		69			194			627			450	
Approach Delay, s/veh		30.7			38.1			11.7			19.3	
Approach LOS		C			D			B			B	
Timer - Assigned Phs	1	2		4	5	6		8				
Phs Duration (G+Y+Rc), s	7.1	55.3		17.6	13.1	49.3		17.6				
Change Period (Y+Rc), s	5.7	5.7		6.1	5.7	5.7		6.1				
Max Green Setting (Gmax), s	14.3	34.3		13.9	9.3	34.3		13.9				
Max Q Clear Time (g_c+I1), s	2.7	4.4		11.3	7.8	9.4		5.5				
Green Ext Time (p_c), s	0.0	2.7		0.2	0.0	5.4		0.1				

Intersection Summary												
HCM 7th Control Delay, s/veh				19.1								
HCM 7th LOS				B								

Notes
User approved pedestrian interval to be less than phase max green.

HCM Unsignalized Intersection Capacity Analysis
 2: Jefferson Street & Oldham Parkway

Existing Conditions Traffic Volumes
 AM Peak Hour

						
Movement	WBL	WBR	NBT	NBR	SBL	SBT
Lane Configurations						
Traffic Volume (veh/h)	181	107	37	47	38	38
Future Volume (Veh/h)	181	107	37	47	38	38
Sign Control	Free		Stop		Stop	
Grade	0%		0%		0%	
Peak Hour Factor	0.93	0.93	0.93	0.93	0.93	0.93
Hourly flow rate (vph)	195	115	40	51	41	41
Pedestrians						
Lane Width (ft)						
Walking Speed (ft/s)						
Percent Blockage						
Right turn flare (veh)						
Median type	None					
Median storage (veh)						
Upstream signal (ft)	368					
pX, platoon unblocked						
vC, conflicting volume	0		505	0	461	390
vC1, stage 1 conf vol						
vC2, stage 2 conf vol						
vCu, unblocked vol	0		505	0	461	390
tC, single (s)	4.1		6.5	6.2	7.1	6.5
tC, 2 stage (s)						
tF (s)	2.2		4.0	3.3	3.5	4.0
p0 queue free %	88		90	95	90	91
cM capacity (veh/h)	1623		413	1085	410	480
Direction, Lane #	WB 1	WB 2	NB 1	SB 1		
Volume Total	195	115	91	82		
Volume Left	195	0	0	41		
Volume Right	0	115	51	0		
cSH	1623	1700	633	442		
Volume to Capacity	0.12	0.07	0.14	0.19		
Queue Length 95th (ft)	10	0	13	17		
Control Delay (s/veh)	7.5	0.0	11.6	15.0		
Lane LOS	A		B	B		
Approach Delay (s/veh)	4.7		11.6	15.0		
Approach LOS			B	B		
Intersection Summary						
Average Delay			7.8			
Intersection Capacity Utilization			27.5%	ICU Level of Service	A	
Analysis Period (min)			15			

Queues
3: M-291 & Oldham Parkway

Existing Conditions Traffic Volumes
AM Peak Hour



























Lane Group	EBL	EBR	NBL	NBT	SBT	SBR
Lane Group Flow (vph)	70	19	33	1635	1326	276
v/c Ratio	0.31	0.05	0.17	0.37	0.33	0.21
Control Delay (s/veh)	56.6	0.3	76.1	0.8	5.9	1.2
Queue Delay	0.0	0.0	0.0	0.0	0.0	0.0
Total Delay (s/veh)	56.6	0.3	76.1	0.8	5.9	1.2
Queue Length 50th (ft)	27	0	14	1	134	1
Queue Length 95th (ft)	51	0	m19	1	175	27
Internal Link Dist (ft)				1398	624	
Turn Bay Length (ft)			250			180
Base Capacity (vph)	509	449	224	4337	3967	1294
Starvation Cap Reductn	0	0	0	0	0	0
Spillback Cap Reductn	0	0	0	0	0	0
Storage Cap Reductn	0	0	0	0	0	0
Reduced v/c Ratio	0.14	0.04	0.15	0.38	0.33	0.21

Intersection Summary

m Volume for 95th percentile queue is metered by upstream signal.

HCM 7th Signalized Intersection Summary
3: M-291 & Oldham Parkway

Existing Conditions Traffic Volumes
AM Peak Hour

														
Movement	EBL	EBT	EBR	WBL	WBT	WBR	NBL	NBT	NBR	SBL	SBT	SBR		
Lane Configurations														
Traffic Volume (veh/h)	65	0	18	0	0	0	31	1521	0	0	1233	257		
Future Volume (veh/h)	65	0	18	0	0	0	31	1521	0	0	1233	257		
Initial Q (Qb), veh	0	0	0	0	0	0	0	0	0	0	0	0		
Lane Width Adj.	1.00	1.00	1.00	1.00	1.00	1.00	1.00	1.00	1.00	1.00	1.00	1.00		
Ped-Bike Adj(A_pbT)	1.00		1.00	1.00		1.00	1.00		1.00	1.00		1.00		
Parking Bus, Adj	1.00	1.00	1.00	1.00	1.00	1.00	1.00	1.00	1.00	1.00	1.00	1.00		
Work Zone On Approach		No			No			No			No			
Adj Sat Flow, veh/h/ln	1870	1870	1870	1856	1870	1870	1870	1870	1870	1870	1870	1870		
Adj Flow Rate, veh/h	70	0	0	0	0	0	33	1635	0	0	1326	0		
Peak Hour Factor	0.93	0.93	0.93	0.93	0.93	0.93	0.93	0.93	0.93	0.93	0.93	0.93		
Percent Heavy Veh, %	2	2	2	3	2	2	2	2	2	2	2	2		
Cap, veh/h	130	73		3	2	1	96	4327		3	3878			
Arrive On Green	0.04	0.00	0.00	0.00	0.00	0.00	0.03	0.85	0.00	0.00	0.76	0.00		
Sat Flow, veh/h	3456	1870	1585	3428	1870	1585	3456	5106	1585	3456	5106	1585		
Grp Volume(v), veh/h	70	0	0	0	0	0	33	1635	0	0	1326	0		
Grp Sat Flow(s),veh/h/ln	1728	1870	1585	1714	1870	1585	1728	1702	1585	1728	1702	1585		
Q Serve(g_s), s	2.4	0.0	0.0	0.0	0.0	0.0	1.1	8.6	0.0	0.0	10.1	0.0		
Cycle Q Clear(g_c), s	2.4	0.0	0.0	0.0	0.0	0.0	1.1	8.6	0.0	0.0	10.1	0.0		
Prop In Lane	1.00		1.00	1.00		1.00	1.00		1.00	1.00		1.00		
Lane Grp Cap(c), veh/h	130	73		3	2	1	96	4327		3	3878			
V/C Ratio(X)	0.54	0.00		0.00	0.00	0.00	0.34	0.38		0.00	0.34			
Avail Cap(c_a), veh/h	513	281		220	128	108	225	4327		239	3878			
HCM Platoon Ratio	1.00	1.00	1.00	1.00	1.00	1.00	1.00	1.00	1.00	1.00	1.00	1.00		
Upstream Filter(I)	1.00	0.00	0.00	0.00	0.00	0.00	0.81	0.81	0.00	0.00	1.00	0.00		
Uniform Delay (d), s/veh	56.7	0.0	0.0	0.0	0.0	0.0	57.3	2.1	0.0	0.0	4.7	0.0		
Incr Delay (d2), s/veh	3.4	0.0	0.0	0.0	0.0	0.0	1.7	0.2	0.0	0.0	0.2	0.0		
Initial Q Delay(d3), s/veh	0.0	0.0	0.0	0.0	0.0	0.0	0.0	0.0	0.0	0.0	0.0	0.0		
%ile BackOfQ(95%),veh/ln	2.0	0.0	0.0	0.0	0.0	0.0	0.9	2.4	0.0	0.0	4.9	0.0		
Unsig. Movement Delay, s/veh														
LnGrp Delay(d), s/veh	60.2	0.0	0.0	0.0	0.0	0.0	59.0	2.3	0.0	0.0	4.9	0.0		
LnGrp LOS	E							E		A		A		
Approach Vol, veh/h					0				1668				1326	
Approach Delay, s/veh					0.0				3.4				4.9	
Approach LOS	E								A				A	
Timer - Assigned Phs	1	2	3	4	5	6	7	8						
Phs Duration (G+Y+Rc), s	0.0	108.3	0.0	11.7	10.5	97.7	11.7	0.0						
Change Period (Y+Rc), s	6.7	* 6.6	7.3	7.0	7.2	6.6	7.2	* 7						
Max Green Setting (Gmax), s	8.3	* 59	7.7	18.0	7.8	58.4	17.8	* 8.2						
Max Q Clear Time (g_c+I1), s	0.0	10.6	0.0	0.0	3.1	12.1	4.4	0.0						
Green Ext Time (p_c), s	0.0	24.2	0.0	0.0	0.0	17.6	0.1	0.0						
Intersection Summary														
HCM 7th Control Delay, s/veh			5.3											
HCM 7th LOS			A											
Notes														
* HCM 7th computational engine requires equal clearance times for the phases crossing the barrier.														
Unsignalized Delay for [NBR, EBR, SBR] is excluded from calculations of the approach delay and intersection delay.														

Queues
4: Jefferson Street & Persels Road

Existing Conditions Traffic Volumes
AM Peak Hour



Lane Group	EBL	EBT	WBL	WBT	NBL	NBT	SBL	SBT
Lane Group Flow (vph)	4	234	290	211	16	232	14	208
v/c Ratio	0.00	0.13	0.35	0.17	0.06	0.59	0.06	0.65
Control Delay (s/veh)	11.0	17.9	5.3	5.9	30.9	26.5	28.3	52.1
Queue Delay	0.0	0.0	0.0	0.0	0.0	0.0	0.0	0.0
Total Delay (s/veh)	11.0	17.9	5.3	5.9	30.9	26.5	28.3	52.1
Queue Length 50th (ft)	1	40	65	45	11	74	8	153
Queue Length 95th (ft)	6	93	121	126	24	150	20	206
Internal Link Dist (ft)		356		523		340		1357
Turn Bay Length (ft)	110		175		110		150	
Base Capacity (vph)	881	1786	847	1222	343	507	335	462
Starvation Cap Reductn	0	0	0	0	0	0	0	0
Spillback Cap Reductn	0	0	0	0	0	0	0	0
Storage Cap Reductn	0	0	0	0	0	0	0	0
Reduced v/c Ratio	0.00	0.13	0.34	0.17	0.05	0.46	0.04	0.45
Intersection Summary								

HCM 7th Signalized Intersection Summary
4: Jefferson Street & Persels Road

Existing Conditions Traffic Volumes
AM Peak Hour



Movement	EBL	EBT	EBR	WBL	WBT	WBR	NBL	NBT	NBR	SBL	SBT	SBR
Lane Configurations	↶	↷		↶	↷		↶	↷		↶	↷	
Traffic Volume (veh/h)	4	185	33	270	178	19	15	52	164	13	179	15
Future Volume (veh/h)	4	185	33	270	178	19	15	52	164	13	179	15
Initial Q (Qb), veh	0	0	0	0	0	0	0	0	0	0	0	0
Lane Width Adj.	1.00	1.00	1.00	1.00	1.00	1.00	1.00	1.00	1.00	1.00	1.00	1.00
Ped-Bike Adj(A_pbT)	1.00		1.00	1.00		1.00	1.00		1.00	1.00		1.00
Parking Bus, Adj	1.00	1.00	1.00	1.00	1.00	1.00	1.00	1.00	1.00	1.00	1.00	1.00
Work Zone On Approach		No			No			No			No	
Adj Sat Flow, veh/h/ln	1870	1870	1870	1870	1870	1752	1870	1870	1870	1870	1870	1870
Adj Flow Rate, veh/h	4	199	35	290	191	20	16	56	176	14	192	16
Peak Hour Factor	0.93	0.93	0.93	0.93	0.93	0.93	0.93	0.93	0.93	0.93	0.93	0.93
Percent Heavy Veh, %	2	2	2	2	2	10	2	2	2	2	2	2
Cap, veh/h	708	1629	282	811	1039	109	189	67	209	151	280	23
Arrive On Green	0.01	0.54	0.54	0.16	1.00	1.00	0.03	0.17	0.17	0.03	0.16	0.16
Sat Flow, veh/h	1781	3029	524	1781	1665	174	1781	397	1248	1781	1703	142
Grp Volume(v), veh/h	4	115	119	290	0	211	16	0	232	14	0	208
Grp Sat Flow(s),veh/h/ln	1781	1777	1776	1781	0	1839	1781	0	1646	1781	0	1845
Q Serve(g_s), s	0.1	3.8	4.0	8.7	0.0	0.0	0.9	0.0	16.4	0.8	0.0	12.7
Cycle Q Clear(g_c), s	0.1	3.8	4.0	8.7	0.0	0.0	0.9	0.0	16.4	0.8	0.0	12.7
Prop In Lane	1.00		0.29	1.00		0.09	1.00		0.76	1.00		0.08
Lane Grp Cap(c), veh/h	708	956	955	811	0	1148	189	0	276	151	0	303
V/C Ratio(X)	0.01	0.12	0.12	0.36	0.00	0.18	0.08	0.00	0.84	0.09	0.00	0.69
Avail Cap(c_a), veh/h	987	956	955	936	0	1148	425	0	411	392	0	461
HCM Platoon Ratio	1.00	1.00	1.00	1.67	1.67	1.67	1.00	1.00	1.00	1.00	1.00	1.00
Upstream Filter(I)	1.00	1.00	1.00	0.90	0.00	0.90	1.00	0.00	1.00	1.00	0.00	1.00
Uniform Delay (d), s/veh	12.3	13.7	13.7	8.4	0.0	0.0	39.6	0.0	48.4	40.2	0.0	47.2
Incr Delay (d2), s/veh	0.0	0.3	0.3	0.3	0.0	0.3	0.3	0.0	15.1	0.4	0.0	5.8
Initial Q Delay(d3), s/veh	0.0	0.0	0.0	0.0	0.0	0.0	0.0	0.0	0.0	0.0	0.0	0.0
%ile BackOfQ(95%),veh/ln	0.1	2.9	2.9	5.0	0.0	0.2	0.7	0.0	12.4	0.6	0.0	10.4
Unsig. Movement Delay, s/veh												
LnGrp Delay(d), s/veh	12.3	14.0	14.0	8.7	0.0	0.3	39.8	0.0	63.5	40.6	0.0	53.0
LnGrp LOS	B	B	B	A		A	D		E	D		D
Approach Vol, veh/h		238			501			248			222	
Approach Delay, s/veh		13.9			5.2			62.0			52.2	
Approach LOS		B			A			E			D	
Timer - Assigned Phs	1	2	3	4	5	6	7	8				
Phs Duration (G+Y+Rc), s	16.6	69.5	8.7	25.1	6.2	79.9	9.1	24.7				
Change Period (Y+Rc), s	5.0	5.0	5.0	5.0	5.0	5.0	5.0	5.0				
Max Green Setting (Gmax), s	20.0	30.0	20.0	30.0	20.0	30.0	20.0	30.0				
Max Q Clear Time (g_c+I1), s	10.7	6.0	2.8	18.4	2.1	2.0	2.9	14.7				
Green Ext Time (p_c), s	0.9	2.4	0.0	1.7	0.0	2.3	0.0	1.7				
Intersection Summary												
HCM 7th Control Delay, s/veh				27.2								
HCM 7th LOS				C								

Queues
5: M-291 & Persels Road/Bailey Road

Existing Conditions Traffic Volumes
AM Peak Hour

























Lane Group	EBL	EBT	WBL	WBT	WBR	NBL	NBT	NBR	SBL	SBT	SBR
Lane Group Flow (vph)	265	124	187	134	43	45	1444	288	30	958	394
v/c Ratio	0.74	0.53	0.55	0.61	0.13	0.34	0.53	0.29	0.25	0.53	0.39
Control Delay (s/veh)	63.6	51.3	57.5	61.5	0.9	59.8	21.1	3.2	50.8	33.4	13.4
Queue Delay	0.0	0.0	0.0	0.0	0.0	0.0	0.0	0.0	0.0	0.0	0.0
Total Delay (s/veh)	63.6	51.3	57.5	61.5	0.9	59.8	21.1	3.2	50.8	33.4	13.4
Queue Length 50th (ft)	85	93	72	100	0	34	281	0	23	294	22
Queue Length 95th (ft)	#154	114	107	157	0	72	380	52	54	485	239
Internal Link Dist (ft)		523		687			649			1398	
Turn Bay Length (ft)	200		280		290	310		350	330		
Base Capacity (vph)	371	277	512	355	420	162	2710	978	135	1781	998
Starvation Cap Reductn	0	0	0	0	0	0	0	0	0	0	0
Spillback Cap Reductn	0	0	0	0	0	0	0	0	0	0	0
Storage Cap Reductn	0	0	0	0	0	0	0	0	0	0	0
Reduced v/c Ratio	0.71	0.45	0.37	0.38	0.10	0.28	0.53	0.29	0.22	0.54	0.39

Intersection Summary

95th percentile volume exceeds capacity, queue may be longer.
Queue shown is maximum after two cycles.

HCM 7th Signalized Intersection Summary
5: M-291 & Persels Road/Bailey Road

Existing Conditions Traffic Volumes
AM Peak Hour

												
Movement	EBL	EBT	EBR	WBL	WBT	WBR	NBL	NBT	NBR	SBL	SBT	SBR
Lane Configurations												
Traffic Volume (veh/h)	246	91	24	174	125	40	42	1343	268	28	891	366
Future Volume (veh/h)	246	91	24	174	125	40	42	1343	268	28	891	366
Initial Q (Qb), veh	0	0	0	0	0	0	0	0	0	0	0	0
Lane Width Adj.	1.00	1.00	1.00	1.00	1.00	1.00	1.00	1.00	1.00	1.00	1.00	1.00
Ped-Bike Adj(A_pbT)	1.00		1.00	1.00		1.00	1.00		1.00	1.00		1.00
Parking Bus, Adj	1.00	1.00	1.00	1.00	1.00	1.00	1.00	1.00	1.00	1.00	1.00	1.00
Work Zone On Approach		No			No			No			No	
Adj Sat Flow, veh/h/ln	1870	1870	1841	1870	1870	1856	1870	1870	1870	1870	1856	1870
Adj Flow Rate, veh/h	265	98	26	187	134	43	45	1444	0	30	958	0
Peak Hour Factor	0.93	0.93	0.93	0.93	0.93	0.93	0.93	0.93	0.93	0.93	0.93	0.93
Percent Heavy Veh, %	2	2	4	2	2	3	2	2	2	2	3	2
Cap, veh/h	326	160	42	252	171	144	81	2836		66	1926	
Arrive On Green	0.03	0.04	0.04	0.07	0.09	0.09	0.05	0.56	0.00	0.01	0.18	0.00
Sat Flow, veh/h	3456	1424	378	3456	1870	1572	1781	5106	1585	1781	3526	1585
Grp Volume(v), veh/h	265	0	124	187	134	43	45	1444	0	30	958	0
Grp Sat Flow(s),veh/h/ln	1728	0	1802	1728	1870	1572	1781	1702	1585	1781	1763	1585
Q Serve(g_s), s	9.1	0.0	8.1	6.4	8.4	3.1	3.0	21.0	0.0	2.0	29.4	0.0
Cycle Q Clear(g_c), s	9.1	0.0	8.1	6.4	8.4	3.1	3.0	21.0	0.0	2.0	29.4	0.0
Prop In Lane	1.00		0.21	1.00		1.00	1.00		1.00	1.00		1.00
Lane Grp Cap(c), veh/h	326	0	202	252	171	144	81	2836		66	1926	
V/C Ratio(X)	0.81	0.00	0.61	0.74	0.78	0.30	0.56	0.51		0.46	0.50	
Avail Cap(c_a), veh/h	374	0	270	515	357	300	162	2836		134	1926	
HCM Platoon Ratio	0.33	0.33	0.33	1.00	1.00	1.00	1.00	1.00	1.00	0.33	0.33	0.33
Upstream Filter(I)	1.00	0.00	1.00	1.00	1.00	1.00	1.00	1.00	0.00	0.95	0.95	0.00
Uniform Delay (d), s/veh	57.1	0.0	55.2	54.5	53.3	50.9	56.1	16.5	0.0	58.1	34.4	0.0
Incr Delay (d2), s/veh	11.5	0.0	3.0	4.3	7.5	1.1	5.9	0.7	0.0	4.6	0.9	0.0
Initial Q Delay(d3), s/veh	0.0	0.0	0.0	0.0	0.0	0.0	0.0	0.0	0.0	0.0	0.0	0.0
%ile BackOfQ(95%),veh/ln	8.3	0.0	7.2	5.2	7.7	2.2	2.6	12.3	0.0	1.8	20.0	0.0
Unsig. Movement Delay, s/veh												
LnGrp Delay(d), s/veh	68.5	0.0	58.2	58.9	60.9	52.0	62.0	17.2	0.0	62.7	35.2	0.0
LnGrp LOS	E		E	E	E	D	E	B		E	D	
Approach Vol, veh/h		389			364			1489			988	
Approach Delay, s/veh		65.2			58.8			18.5			36.1	
Approach LOS		E			E			B			D	
Timer - Assigned Phs	1	2	3	4	5	6	7	8				
Phs Duration (G+Y+Rc), s	10.4	73.2	15.8	20.6	11.5	72.0	18.3	18.1				
Change Period (Y+Rc), s	6.0	6.5	7.1	* 7.1	6.1	* 6.5	7.0	7.1				
Max Green Setting (Gmax), s	9.0	48.5	17.9	* 18	10.9	* 47	13.0	22.9				
Max Q Clear Time (g_c+I1), s	4.0	23.0	8.4	10.1	5.0	31.4	11.1	10.4				
Green Ext Time (p_c), s	0.0	20.1	0.4	0.3	0.0	10.3	0.2	0.6				
Intersection Summary												
HCM 7th Control Delay, s/veh			34.1									
HCM 7th LOS			C									
Notes												
* HCM 7th computational engine requires equal clearance times for the phases crossing the barrier.												
Unsignalized Delay for [NBR, SBR] is excluded from calculations of the approach delay and intersection delay.												

Queues
1: Ward Road & Oldham Parkway

Existing Conditions Traffic Volumes
PM Peak Hour



Lane Group	EBL	EBT	WBT	NBL	NBT	SBL	SBT	SBR
Lane Group Flow (vph)	136	70	179	30	554	122	569	186
v/c Ratio	0.61	0.18	0.40	0.19	0.32	0.56	0.27	0.18
Control Delay (s/veh)	40.5	13.9	11.7	36.4	15.2	44.0	11.2	2.9
Queue Delay	0.0	0.0	0.0	0.0	0.0	0.0	0.0	0.0
Total Delay (s/veh)	40.5	13.9	11.7	36.4	15.2	44.0	11.2	2.9
Queue Length 50th (ft)	61	12	21	14	94	58	57	0
Queue Length 95th (ft)	114	42	69	38	140	#124	142	36
Internal Link Dist (ft)		116	246		459		353	
Turn Bay Length (ft)				110		105		
Base Capacity (vph)	231	397	453	316	1901	227	2057	998
Starvation Cap Reductn	0	0	0	0	0	0	0	0
Spillback Cap Reductn	0	0	0	0	0	0	0	0
Storage Cap Reductn	0	0	0	0	0	0	0	0
Reduced v/c Ratio	0.59	0.18	0.40	0.09	0.29	0.54	0.28	0.19

Intersection Summary

95th percentile volume exceeds capacity, queue may be longer.
Queue shown is maximum after two cycles.

HCM 7th Signalized Intersection Summary
1: Ward Road & Oldham Parkway

Existing Conditions Traffic Volumes
PM Peak Hour













Movement	EBL	EBT	EBR	WBL	WBT	WBR	NBL	NBT	NBR	SBL	SBT	SBR
Lane Configurations												
Traffic Volume (veh/h)	133	29	39	13	38	124	29	529	14	120	558	182
Future Volume (veh/h)	133	29	39	13	38	124	29	529	14	120	558	182
Initial Q (Qb), veh	0	0	0	0	0	0	0	0	0	0	0	0
Lane Width Adj.	1.00	1.00	1.00	1.00	1.00	1.00	1.00	1.00	1.00	1.00	1.00	1.00
Ped-Bike Adj(A_pbT)	1.00		1.00	1.00		1.00	1.00		1.00	1.00		1.00
Parking Bus, Adj	1.00	1.00	1.00	1.00	1.00	1.00	1.00	1.00	1.00	1.00	1.00	1.00
Work Zone On Approach		No			No			No			No	
Adj Sat Flow, veh/h/ln	1870	1870	1870	1870	1870	1870	1870	1870	1870	1870	1870	1870
Adj Flow Rate, veh/h	136	30	40	13	39	127	30	540	14	122	569	186
Peak Hour Factor	0.98	0.98	0.98	0.98	0.98	0.98	0.98	0.98	0.98	0.98	0.98	0.98
Percent Heavy Veh, %	2	2	2	2	2	2	2	2	2	2	2	2
Cap, veh/h	254	119	159	57	69	190	54	1879	49	154	2086	930
Arrive On Green	0.16	0.16	0.16	0.16	0.16	0.16	0.03	0.53	0.53	0.09	0.59	0.59
Sat Flow, veh/h	1220	727	969	56	420	1162	1781	3539	92	1781	3554	1585
Grp Volume(v), veh/h	136	0	70	179	0	0	30	271	283	122	569	186
Grp Sat Flow(s),veh/h/ln	1220	0	1696	1638	0	0	1781	1777	1854	1781	1777	1585
Q Serve(g_s), s	2.9	0.0	2.9	1.3	0.0	0.0	1.3	6.8	6.8	5.4	6.3	4.4
Cycle Q Clear(g_c), s	11.0	0.0	2.9	8.1	0.0	0.0	1.3	6.8	6.8	5.4	6.3	4.4
Prop In Lane	1.00		0.57	0.07		0.71	1.00		0.05	1.00		1.00
Lane Grp Cap(c), veh/h	254	0	278	317	0	0	54	943	984	154	2086	930
V/C Ratio(X)	0.54	0.00	0.25	0.57	0.00	0.00	0.55	0.29	0.29	0.79	0.27	0.20
Avail Cap(c_a), veh/h	266	0	295	333	0	0	318	943	984	207	2086	930
HCM Platoon Ratio	1.00	1.00	1.00	1.00	1.00	1.00	1.00	1.00	1.00	1.00	1.00	1.00
Upstream Filter(I)	1.00	0.00	1.00	1.00	0.00	0.00	1.00	1.00	1.00	1.00	1.00	1.00
Uniform Delay (d), s/veh	33.0	0.0	29.2	31.4	0.0	0.0	38.2	10.4	10.4	35.8	8.1	7.7
Incr Delay (d2), s/veh	1.9	0.0	0.5	2.0	0.0	0.0	8.5	0.8	0.7	13.7	0.3	0.5
Initial Q Delay(d3), s/veh	0.0	0.0	0.0	0.0	0.0	0.0	0.0	0.0	0.0	0.0	0.0	0.0
%ile BackOfQ(95%),veh/ln	4.8	0.0	2.2	5.9	0.0	0.0	1.2	4.6	4.8	5.1	3.9	2.5
Unsig. Movement Delay, s/veh												
LnGrp Delay(d), s/veh	34.9	0.0	29.6	33.4	0.0	0.0	46.8	11.2	11.1	49.5	8.4	8.2
LnGrp LOS	C		C	C			D	B	B	D	A	A
Approach Vol, veh/h		206			179			584			877	
Approach Delay, s/veh		33.1			33.4			13.0			14.1	
Approach LOS		C			C			B			B	
Timer - Assigned Phs	1	2		4	5	6		8				
Phs Duration (G+Y+Rc), s	8.1	52.7		19.2	12.6	48.2		19.2				
Change Period (Y+Rc), s	5.7	5.7		6.1	5.7	5.7		6.1				
Max Green Setting (Gmax), s	14.3	34.3		13.9	9.3	34.3		13.9				
Max Q Clear Time (g_c+I1), s	3.3	8.3		10.1	7.4	8.8		13.0				
Green Ext Time (p_c), s	0.0	6.6		0.3	0.0	4.8		0.1				

Intersection Summary												
HCM 7th Control Delay, s/veh				17.7								
HCM 7th LOS				B								

Notes
User approved pedestrian interval to be less than phase max green.

HCM Unsignalized Intersection Capacity Analysis
 2: Jefferson Street & Oldham Parkway

Existing Conditions Traffic Volumes
 PM Peak Hour

						
Movement	WBL	WBR	NBT	NBR	SBL	SBT
Lane Configurations						
Traffic Volume (veh/h)	64	69	31	37	89	20
Future Volume (Veh/h)	64	69	31	37	89	20
Sign Control	Free		Stop		Stop	
Grade	0%		0%		0%	
Peak Hour Factor	0.98	0.98	0.98	0.98	0.98	0.98
Hourly flow rate (vph)	65	70	32	38	91	20
Pedestrians						
Lane Width (ft)						
Walking Speed (ft/s)						
Percent Blockage						
Right turn flare (veh)						
Median type	None					
Median storage (veh)						
Upstream signal (ft)	368					
pX, platoon unblocked						
vC, conflicting volume	0		200	0	184	130
vC1, stage 1 conf vol						
vC2, stage 2 conf vol						
vCu, unblocked vol	0		200	0	184	130
tC, single (s)	4.1		6.5	6.2	7.1	6.5
tC, 2 stage (s)						
tF (s)	2.2		4.0	3.3	3.5	4.0
p0 queue free %	96		95	96	87	97
cM capacity (veh/h)	1623		668	1085	700	730
Direction, Lane #	WB 1	WB 2	NB 1	SB 1		
Volume Total	65	70	70	111		
Volume Left	65	0	0	91		
Volume Right	0	70	38	0		
cSH	1623	1700	844	706		
Volume to Capacity	0.04	0.04	0.08	0.16		
Queue Length 95th (ft)	3	0	7	14		
Control Delay (s/veh)	7.3	0.0	9.6	11.1		
Lane LOS	A		A	B		
Approach Delay (s/veh)	3.5		9.6	11.1		
Approach LOS			A	B		
Intersection Summary						
Average Delay			7.5			
Intersection Capacity Utilization			22.9%	ICU Level of Service	A	
Analysis Period (min)			15			

Queues
3: M-291 & Oldham Parkway

Existing Conditions Traffic Volumes
PM Peak Hour



























Lane Group	EBL	EBR	NBL	NBT	SBT	SBR
Lane Group Flow (vph)	92	30	20	1531	1874	112
v/c Ratio	0.37	0.09	0.05	0.37	0.47	0.08
Control Delay (s/veh)	56.8	0.5	0.7	2.3	6.3	0.1
Queue Delay	0.0	0.0	0.0	0.0	0.0	0.0
Total Delay (s/veh)	56.8	0.5	0.7	2.3	6.3	0.1
Queue Length 50th (ft)	35	0	0	3	124	0
Queue Length 95th (ft)	61	0	m0	140	274	0
Internal Link Dist (ft)				1398	624	
Turn Bay Length (ft)			250			180
Base Capacity (vph)	509	435	450	4135	3912	1271
Starvation Cap Reductn	0	0	0	0	0	0
Spillback Cap Reductn	0	0	0	0	0	0
Storage Cap Reductn	0	0	0	0	0	0
Reduced v/c Ratio	0.18	0.07	0.04	0.37	0.48	0.09

Intersection Summary

m Volume for 95th percentile queue is metered by upstream signal.

HCM 7th Signalized Intersection Summary
3: M-291 & Oldham Parkway

Existing Conditions Traffic Volumes
PM Peak Hour

														
Movement	EBL	EBT	EBR	WBL	WBT	WBR	NBL	NBT	NBR	SBL	SBT	SBR		
Lane Configurations														
Traffic Volume (veh/h)	90	0	29	0	0	0	20	1500	0	0	1837	110		
Future Volume (veh/h)	90	0	29	0	0	0	20	1500	0	0	1837	110		
Initial Q (Qb), veh	0	0	0	0	0	0	0	0	0	0	0	0		
Lane Width Adj.	1.00	1.00	1.00	1.00	1.00	1.00	1.00	1.00	1.00	1.00	1.00	1.00		
Ped-Bike Adj(A_pbT)	1.00		1.00	1.00		1.00	1.00		1.00	1.00		1.00		
Parking Bus, Adj	1.00	1.00	1.00	1.00	1.00	1.00	1.00	1.00	1.00	1.00	1.00	1.00		
Work Zone On Approach		No			No			No			No			
Adj Sat Flow, veh/h/ln	1870	1870	1870	1870	1870	1870	1870	1870	1870	1870	1870	1870		
Adj Flow Rate, veh/h	92	0	0	0	0	0	20	1531	0	0	1874	0		
Peak Hour Factor	0.98	0.98	0.98	0.98	0.98	0.98	0.98	0.98	0.98	0.98	0.98	0.98		
Percent Heavy Veh, %	2	2	2	2	2	2	2	2	2	2	2	2		
Cap, veh/h	266	82		123	2	1	485	4303		570	3893			
Arrive On Green	0.04	0.00	0.00	0.00	0.00	0.00	0.01	0.56	0.00	0.00	0.76	0.00		
Sat Flow, veh/h	3456	1870	1585	3456	1870	1585	3456	5106	1585	3456	5106	1585		
Grp Volume(v), veh/h	92	0	0	0	0	0	20	1531	0	0	1874	0		
Grp Sat Flow(s),veh/h/ln	1728	1870	1585	1728	1870	1585	1728	1702	1585	1728	1702	1585		
Q Serve(g_s), s	3.1	0.0	0.0	0.0	0.0	0.0	0.1	19.6	0.0	0.0	16.5	0.0		
Cycle Q Clear(g_c), s	3.1	0.0	0.0	0.0	0.0	0.0	0.1	19.6	0.0	0.0	16.5	0.0		
Prop In Lane	1.00		1.00	1.00		1.00	1.00		1.00	1.00		1.00		
Lane Grp Cap(c), veh/h	266	82		123	2	1	485	4303		570	3893			
V/C Ratio(X)	0.35	0.00		0.00	0.00	0.00	0.04	0.36		0.00	0.48			
Avail Cap(c_a), veh/h	633	281		342	128	108	640	4303		807	3893			
HCM Platoon Ratio	1.00	1.00	1.00	1.00	1.00	1.00	0.67	0.67	0.67	1.00	1.00	1.00		
Upstream Filter(I)	1.00	0.00	0.00	0.00	0.00	0.00	0.85	0.85	0.00	0.00	1.00	0.00		
Uniform Delay (d), s/veh	56.4	0.0	0.0	0.0	0.0	0.0	4.0	8.4	0.0	0.0	5.3	0.0		
Incr Delay (d2), s/veh	0.8	0.0	0.0	0.0	0.0	0.0	0.0	0.2	0.0	0.0	0.4	0.0		
Initial Q Delay(d3), s/veh	0.0	0.0	0.0	0.0	0.0	0.0	0.0	0.0	0.0	0.0	0.0	0.0		
%ile BackOfQ(95%),veh/ln	2.5	0.0	0.0	0.0	0.0	0.0	0.1	12.1	0.0	0.0	7.9	0.0		
Unsig. Movement Delay, s/veh														
LnGrp Delay(d), s/veh	57.2	0.0	0.0	0.0	0.0	0.0	4.0	8.6	0.0	0.0	5.8	0.0		
LnGrp LOS	E							A		A		A		
Approach Vol, veh/h					92			0			1551		1874	
Approach Delay, s/veh					57.2			0.0			8.5		5.8	
Approach LOS					E						A		A	
Timer - Assigned Phs	1	2	3	4	5	6	7	8						
Phs Duration (G+Y+Rc), s	0.0	107.7	0.0	12.3	9.6	98.1	12.3	0.0						
Change Period (Y+Rc), s	6.7	* 6.6	7.3	7.0	7.2	6.6	7.2	* 7						
Max Green Setting (Gmax), s	8.3	* 59	7.7	18.0	7.8	58.4	17.8	* 8.2						
Max Q Clear Time (g_c+I1), s	0.0	21.6	0.0	0.0	2.1	18.5	5.1	0.0						
Green Ext Time (p_c), s	0.0	19.4	0.0	0.0	0.0	26.1	0.2	0.0						
Intersection Summary														
HCM 7th Control Delay, s/veh			8.3											
HCM 7th LOS			A											
Notes														
User approved pedestrian interval to be less than phase max green.														
* HCM 7th computational engine requires equal clearance times for the phases crossing the barrier.														

Unsignalized Delay for [NBR, EBR, SBR] is excluded from calculations of the approach delay and intersection delay.

Queues
4: Jefferson Street & Persels Road





















Existing Conditions Traffic Volumes
PM Peak Hour



Lane Group	EBL	EBT	WBL	WBT	NBL	NBT	SBL	SBT
Lane Group Flow (vph)	6	233	154	265	18	201	14	71
v/c Ratio	0.00	0.11	0.18	0.20	0.07	0.56	0.07	0.28
Control Delay (s/veh)	7.0	11.6	7.4	8.4	36.7	18.5	39.5	40.9
Queue Delay	0.0	0.0	0.0	0.0	0.0	0.0	0.0	0.0
Total Delay (s/veh)	7.0	11.6	7.4	8.4	36.7	18.5	39.5	40.9
Queue Length 50th (ft)	1	30	9	16	13	27	10	39
Queue Length 95th (ft)	7	73	64	102	29	100	26	83
Internal Link Dist (ft)		356		523		340		1357
Turn Bay Length (ft)	110		175		110		150	
Base Capacity (vph)	817	2116	857	1313	254	592	193	532
Starvation Cap Reductn	0	0	0	0	0	0	0	0
Spillback Cap Reductn	0	0	0	0	0	0	0	0
Storage Cap Reductn	0	0	0	0	0	0	0	0
Reduced v/c Ratio	0.01	0.11	0.18	0.20	0.07	0.34	0.07	0.13
Intersection Summary								

HCM 7th Signalized Intersection Summary
4: Jefferson Street & Persels Road

Existing Conditions Traffic Volumes
PM Peak Hour

												
Movement	EBL	EBT	EBR	WBL	WBT	WBR	NBL	NBT	NBR	SBL	SBT	SBR
Lane Configurations												
Traffic Volume (veh/h)	6	213	16	151	244	16	18	37	160	14	49	21
Future Volume (veh/h)	6	213	16	151	244	16	18	37	160	14	49	21
Initial Q (Qb), veh	0	0	0	0	0	0	0	0	0	0	0	0
Lane Width Adj.	1.00	1.00	1.00	1.00	1.00	1.00	1.00	1.00	1.00	1.00	1.00	1.00
Ped-Bike Adj(A_pbT)	1.00		1.00	1.00		1.00	1.00		1.00	1.00		1.00
Parking Bus, Adj	1.00	1.00	1.00	1.00	1.00	1.00	1.00	1.00	1.00	1.00	1.00	1.00
Work Zone On Approach		No			No			No			No	
Adj Sat Flow, veh/h/ln	1870	1870	1870	1870	1870	1870	1870	1870	1870	1870	1870	1870
Adj Flow Rate, veh/h	6	217	16	154	249	16	18	38	163	14	50	21
Peak Hour Factor	0.98	0.98	0.98	0.98	0.98	0.98	0.98	0.98	0.98	0.98	0.98	0.98
Percent Heavy Veh, %	2	2	2	2	2	2	2	2	2	2	2	2
Cap, veh/h	662	1906	139	824	1105	71	273	47	201	154	182	76
Arrive On Green	0.02	0.57	0.57	0.03	0.21	0.21	0.04	0.15	0.15	0.03	0.15	0.15
Sat Flow, veh/h	1781	3357	246	1781	1739	112	1781	309	1324	1781	1251	525
Grp Volume(v), veh/h	6	114	119	154	0	265	18	0	201	14	0	71
Grp Sat Flow(s),veh/h/ln	1781	1777	1826	1781	0	1850	1781	0	1632	1781	0	1776
Q Serve(g_s), s	0.2	3.6	3.6	3.8	0.0	14.3	1.0	0.0	14.3	0.8	0.0	4.3
Cycle Q Clear(g_c), s	0.2	3.6	3.6	3.8	0.0	14.3	1.0	0.0	14.3	0.8	0.0	4.3
Prop In Lane	1.00		0.13	1.00		0.06	1.00		0.81	1.00		0.30
Lane Grp Cap(c), veh/h	662	1009	1036	824	0	1176	273	0	248	154	0	258
V/C Ratio(X)	0.01	0.11	0.11	0.19	0.00	0.23	0.07	0.00	0.81	0.09	0.00	0.28
Avail Cap(c_a), veh/h	784	1009	1036	885	0	1176	354	0	476	247	0	518
HCM Platoon Ratio	1.00	1.00	1.00	0.33	0.33	0.33	1.00	1.00	1.00	1.00	1.00	1.00
Upstream Filter(I)	1.00	1.00	1.00	0.91	0.00	0.91	1.00	0.00	1.00	1.00	0.00	1.00
Uniform Delay (d), s/veh	10.6	12.0	12.0	7.9	0.0	22.9	40.5	0.0	49.2	41.8	0.0	45.7
Incr Delay (d2), s/veh	0.0	0.2	0.2	0.1	0.0	0.4	0.1	0.0	12.6	0.4	0.0	1.2
Initial Q Delay(d3), s/veh	0.0	0.0	0.0	0.0	0.0	0.0	0.0	0.0	0.0	0.0	0.0	0.0
%ile BackOfQ(95%),veh/ln	0.1	2.6	2.7	2.6	0.0	11.4	0.8	0.0	10.9	0.6	0.0	3.5
Unsig. Movement Delay, s/veh												
LnGrp Delay(d), s/veh	10.6	12.2	12.2	8.0	0.0	23.3	40.7	0.0	61.8	42.2	0.0	46.9
LnGrp LOS	B	B	B	A		C	D		E	D		D
Approach Vol, veh/h		239			419			219				85
Approach Delay, s/veh		12.2			17.7			60.1				46.1
Approach LOS		B			B			E				D
Timer - Assigned Phs	1	2	3	4	5	6	7	8				
Phs Duration (G+Y+Rc), s	14.9	73.1	8.7	23.2	6.8	81.2	9.5	22.4				
Change Period (Y+Rc), s	5.0	5.0	5.0	5.0	5.0	5.0	5.0	5.0				
Max Green Setting (Gmax), s	14.0	41.0	10.0	35.0	10.0	45.0	10.0	35.0				
Max Q Clear Time (g_c+I1), s	5.8	5.6	2.8	16.3	2.2	16.3	3.0	6.3				
Green Ext Time (p_c), s	0.4	2.6	0.0	1.9	0.0	3.0	0.0	0.6				
Intersection Summary												
HCM 7th Control Delay, s/veh				28.5								
HCM 7th LOS				C								

Queues
5: M-291 & Persels Road/Bailey Road

Existing Conditions Traffic Volumes
PM Peak Hour



Lane Group	EBL	EBT	WBL	WBT	WBR	NBL	NBT	NBR	SBL	SBT	SBR
Lane Group Flow (vph)	317	170	335	142	78	45	1185	273	32	1594	307
v/c Ratio	0.85	0.76	0.90	0.63	0.24	0.35	0.44	0.28	0.27	0.89	0.33
Control Delay (s/veh)	75.5	67.7	81.7	63.6	1.7	60.2	19.3	2.9	52.0	43.2	15.0
Queue Delay	0.0	0.0	0.0	0.0	0.0	0.0	0.0	0.0	0.0	0.0	0.0
Total Delay (s/veh)	75.5	67.7	81.7	63.6	1.7	60.2	19.3	2.9	52.0	43.2	15.0
Queue Length 50th (ft)	108	121	134	105	0	34	224	0	23	508	37
Queue Length 95th (ft)	#207	#187	#220	174	0	72	272	47	m51	#843	228
Internal Link Dist (ft)		523		687			649			1398	
Turn Bay Length (ft)	200		280		290	310		350	330		
Base Capacity (vph)	371	247	369	246	340	160	2689	965	132	1783	906
Starvation Cap Reductn	0	0	0	0	0	0	0	0	0	0	0
Spillback Cap Reductn	0	0	0	0	0	0	0	0	0	0	0
Storage Cap Reductn	0	0	0	0	0	0	0	0	0	0	0
Reduced v/c Ratio	0.85	0.69	0.91	0.58	0.23	0.28	0.44	0.28	0.24	0.89	0.34

Intersection Summary























95th percentile volume exceeds capacity, queue may be longer.

Queue shown is maximum after two cycles.

m Volume for 95th percentile queue is metered by upstream signal.

HCM 7th Signalized Intersection Summary
5: M-291 & Persels Road/Bailey Road

Existing Conditions Traffic Volumes
PM Peak Hour

												
Movement	EBL	EBT	EBR	WBL	WBT	WBR	NBL	NBT	NBR	SBL	SBT	SBR
Lane Configurations												
Traffic Volume (veh/h)	311	131	35	328	139	76	44	1161	268	31	1562	301
Future Volume (veh/h)	311	131	35	328	139	76	44	1161	268	31	1562	301
Initial Q (Qb), veh	0	0	0	0	0	0	0	0	0	0	0	0
Lane Width Adj.	1.00	1.00	1.00	1.00	1.00	1.00	1.00	1.00	1.00	1.00	1.00	1.00
Ped-Bike Adj(A_pbT)	1.00		1.00	1.00		1.00	1.00		1.00	1.00		1.00
Parking Bus, Adj	1.00	1.00	1.00	1.00	1.00	1.00	1.00	1.00	1.00	1.00	1.00	1.00
Work Zone On Approach		No			No			No			No	
Adj Sat Flow, veh/h/ln	1870	1870	1856	1870	1870	1870	1870	1870	1870	1870	1870	1870
Adj Flow Rate, veh/h	317	134	36	335	142	78	45	1185	0	32	1594	0
Peak Hour Factor	0.98	0.98	0.98	0.98	0.98	0.98	0.98	0.98	0.98	0.98	0.98	0.98
Percent Heavy Veh, %	2	2	3	2	2	2	2	2	2	2	2	2
Cap, veh/h	373	159	43	371	210	178	81	2653		68	1819	
Arrive On Green	0.04	0.04	0.04	0.11	0.11	0.11	0.05	0.52	0.00	0.01	0.17	0.00
Sat Flow, veh/h	3456	1420	382	3456	1870	1585	1781	5106	1585	1781	3554	1585
Grp Volume(v), veh/h	317	0	170	335	142	78	45	1185	0	32	1594	0
Grp Sat Flow(s),veh/h/ln	1728	0	1802	1728	1870	1585	1781	1702	1585	1781	1777	1585
Q Serve(g_s), s	10.9	0.0	11.3	11.5	8.8	5.5	3.0	17.4	0.0	2.1	52.5	0.0
Cycle Q Clear(g_c), s	10.9	0.0	11.3	11.5	8.8	5.5	3.0	17.4	0.0	2.1	52.5	0.0
Prop In Lane	1.00		0.21	1.00		1.00	1.00		1.00	1.00		1.00
Lane Grp Cap(c), veh/h	373	0	202	371	210	178	81	2653		68	1819	
V/C Ratio(X)	0.85	0.00	0.84	0.90	0.67	0.44	0.56	0.45		0.47	0.88	
Avail Cap(c_a), veh/h	374	0	240	371	248	210	162	2653		134	1819	
HCM Platoon Ratio	0.33	0.33	0.33	1.00	1.00	1.00	1.00	1.00	1.00	0.33	0.33	0.33
Upstream Filter(I)	1.00	0.00	1.00	1.00	1.00	1.00	1.00	1.00	0.00	0.88	0.88	0.00
Uniform Delay (d), s/veh	56.9	0.0	56.7	52.9	51.1	49.7	56.1	18.0	0.0	58.0	46.2	0.0
Incr Delay (d2), s/veh	16.6	0.0	20.0	24.3	5.7	1.7	5.9	0.5	0.0	4.4	5.6	0.0
Initial Q Delay(d3), s/veh	0.0	0.0	0.0	0.0	0.0	0.0	0.0	0.0	0.0	0.0	0.0	0.0
%ile BackOfQ(95%),veh/ln	9.9	0.0	10.8	10.3	7.8	4.1	2.6	10.7	0.0	1.9	34.1	0.0
Unsig. Movement Delay, s/veh												
LnGrp Delay(d), s/veh	73.5	0.0	76.8	77.2	56.8	51.4	62.0	18.6	0.0	62.4	51.8	0.0
LnGrp LOS	E		E	E	E	D	E	B		E	D	
Approach Vol, veh/h		487			555			1230			1626	
Approach Delay, s/veh		74.7			68.4			20.2			52.0	
Approach LOS		E			E			C			D	
Timer - Assigned Phs	1	2	3	4	5	6	7	8				
Phs Duration (G+Y+Rc), s	10.6	68.9	20.0	20.6	11.5	67.9	20.0	20.6				
Change Period (Y+Rc), s	6.0	6.5	7.1	* 7.1	6.1	* 6.5	7.0	7.1				
Max Green Setting (Gmax), s	9.0	55.5	12.9	* 16	10.9	* 54	13.0	15.9				
Max Q Clear Time (g_c+I1), s	4.1	19.4	13.5	13.3	5.0	54.5	12.9	10.8				
Green Ext Time (p_c), s	0.0	22.0	0.0	0.2	0.0	0.0	0.0	0.4				
Intersection Summary												
HCM 7th Control Delay, s/veh			47.1									
HCM 7th LOS			D									
Notes												
User approved pedestrian interval to be less than phase max green.												
* HCM 7th computational engine requires equal clearance times for the phases crossing the barrier.												

Unsignalized Delay for [NBR, SBR] is excluded from calculations of the approach delay and intersection delay.

Queues
1: Ward Road & Oldham Parkway

Existing Conditions Traffic Volumes
SAT Peak Hour



Lane Group	EBL	EBT	WBT	NBL	NBT	SBL	SBT	SBR
Lane Group Flow (vph)	164	46	150	32	588	116	397	197
v/c Ratio	0.62	0.11	0.33	0.20	0.35	0.51	0.19	0.20
Control Delay (s/veh)	38.0	12.8	9.3	36.5	16.8	40.5	11.3	3.1
Queue Delay	0.0	0.0	0.0	0.0	0.0	0.0	0.0	0.0
Total Delay (s/veh)	38.0	12.8	9.3	36.5	16.8	40.5	11.3	3.1
Queue Length 50th (ft)	74	7	12	15	102	55	38	0
Queue Length 95th (ft)	127	30	53	40	167	103	104	39
Internal Link Dist (ft)		116	246		459		353	
Turn Bay Length (ft)				110		105		
Base Capacity (vph)	273	402	459	316	1895	238	2027	991
Starvation Cap Reductn	0	0	0	0	0	0	0	0
Spillback Cap Reductn	0	0	0	0	0	0	0	0
Storage Cap Reductn	0	0	0	0	0	0	0	0
Reduced v/c Ratio	0.60	0.11	0.33	0.10	0.31	0.49	0.20	0.20
Intersection Summary								

HCM 7th Signalized Intersection Summary
1: Ward Road & Oldham Parkway

Existing Conditions Traffic Volumes
SAT Peak Hour



Movement	EBL	EBT	EBR	WBL	WBT	WBR	NBL	NBT	NBR	SBL	SBT	SBR
Lane Configurations												
Traffic Volume (veh/h)	154	16	27	11	17	113	30	544	8	109	373	185
Future Volume (veh/h)	154	16	27	11	17	113	30	544	8	109	373	185
Initial Q (Qb), veh	0	0	0	0	0	0	0	0	0	0	0	0
Lane Width Adj.	1.00	1.00	1.00	1.00	1.00	1.00	1.00	1.00	1.00	1.00	1.00	1.00
Ped-Bike Adj(A_pbT)	1.00		1.00	1.00		1.00	1.00		1.00	1.00		1.00
Parking Bus, Adj	1.00	1.00	1.00	1.00	1.00	1.00	1.00	1.00	1.00	1.00	1.00	1.00
Work Zone On Approach		No			No			No			No	
Adj Sat Flow, veh/h/ln	1870	1870	1870	1870	1870	1870	1870	1870	1870	1870	1870	1870
Adj Flow Rate, veh/h	164	17	29	12	18	120	32	579	9	116	397	197
Peak Hour Factor	0.94	0.94	0.94	0.94	0.94	0.94	0.94	0.94	0.94	0.94	0.94	0.94
Percent Heavy Veh, %	2	2	2	2	2	2	2	2	2	2	2	2
Cap, veh/h	282	104	177	58	44	217	57	1879	29	159	2068	922
Arrive On Green	0.17	0.17	0.17	0.17	0.17	0.17	0.03	0.52	0.52	0.09	0.58	0.58
Sat Flow, veh/h	1251	621	1059	59	264	1293	1781	3582	56	1781	3554	1585
Grp Volume(v), veh/h	164	0	46	150	0	0	32	287	301	116	397	197
Grp Sat Flow(s),veh/h/ln	1251	0	1680	1616	0	0	1781	1777	1860	1781	1777	1585
Q Serve(g_s), s	4.6	0.0	1.9	0.0	0.0	0.0	1.4	7.3	7.3	5.1	4.2	4.7
Cycle Q Clear(g_c), s	11.4	0.0	1.9	6.7	0.0	0.0	1.4	7.3	7.3	5.1	4.2	4.7
Prop In Lane	1.00		0.63	0.08		0.80	1.00		0.03	1.00		1.00
Lane Grp Cap(c), veh/h	282	0	282	319	0	0	57	932	976	159	2068	922
V/C Ratio(X)	0.58	0.00	0.16	0.47	0.00	0.00	0.56	0.31	0.31	0.73	0.19	0.21
Avail Cap(c_a), veh/h	289	0	292	329	0	0	318	932	976	207	2068	922
HCM Platoon Ratio	1.00	1.00	1.00	1.00	1.00	1.00	1.00	1.00	1.00	1.00	1.00	1.00
Upstream Filter(I)	1.00	0.00	1.00	1.00	0.00	0.00	1.00	1.00	1.00	1.00	1.00	1.00
Uniform Delay (d), s/veh	32.7	0.0	28.5	30.5	0.0	0.0	38.2	10.8	10.8	35.5	7.9	8.0
Incr Delay (d2), s/veh	2.8	0.0	0.3	1.1	0.0	0.0	8.5	0.9	0.8	8.9	0.2	0.5
Initial Q Delay(d3), s/veh	0.0	0.0	0.0	0.0	0.0	0.0	0.0	0.0	0.0	0.0	0.0	0.0
%ile BackOfQ(95%),veh/ln	5.9	0.0	1.4	4.7	0.0	0.0	1.3	5.0	5.2	4.5	2.6	2.7
Unsig. Movement Delay, s/veh												
LnGrp Delay(d), s/veh	35.5	0.0	28.8	31.6	0.0	0.0	46.7	11.6	11.6	44.4	8.1	8.5
LnGrp LOS	D		C	C			D	B	B	D	A	A
Approach Vol, veh/h		210			150			620			710	
Approach Delay, s/veh		34.0			31.6			13.4			14.1	
Approach LOS		C			C			B			B	
Timer - Assigned Phs	1	2		4	5	6		8				
Phs Duration (G+Y+Rc), s	8.2	52.2		19.5	12.8	47.7		19.5				
Change Period (Y+Rc), s	5.7	5.7		6.1	5.7	5.7		6.1				
Max Green Setting (Gmax), s	14.3	34.3		13.9	9.3	34.3		13.9				
Max Q Clear Time (g_c+I1), s	3.4	6.7		8.7	7.1	9.3		13.4				
Green Ext Time (p_c), s	0.0	4.9		0.3	0.1	5.1		0.0				

Intersection Summary												
HCM 7th Control Delay, s/veh				17.9								
HCM 7th LOS				B								

Notes
User approved pedestrian interval to be less than phase max green.

HCM Unsignalized Intersection Capacity Analysis

2: Jefferson Street & Oldham Parkway

Existing Conditions Traffic Volumes
SAT Peak Hour



Movement	WBL	WBR	NBT	NBR	SBL	SBT
Lane Configurations						
Traffic Volume (veh/h)	21	46	15	8	48	12
Future Volume (Veh/h)	21	46	15	8	48	12
Sign Control	Free		Stop		Stop	
Grade	0%		0%		0%	
Peak Hour Factor	0.94	0.94	0.94	0.94	0.94	0.94
Hourly flow rate (vph)	22	49	16	9	51	13
Pedestrians						
Lane Width (ft)						
Walking Speed (ft/s)						
Percent Blockage						
Right turn flare (veh)						
Median type	None					
Median storage (veh)						
Upstream signal (ft)	368					
pX, platoon unblocked						
vC, conflicting volume	0		93	0	61	44
vC1, stage 1 conf vol						
vC2, stage 2 conf vol						
vCu, unblocked vol	0		93	0	61	44
tC, single (s)	4.1		6.5	6.2	7.1	6.5
tC, 2 stage (s)						
tF (s)	2.2		4.0	3.3	3.5	4.0
p0 queue free %	99		98	99	94	98
cM capacity (veh/h)	1623		786	1085	903	836
Direction, Lane #	WB 1	WB 2	NB 1	SB 1		
Volume Total	22	49	25	64		
Volume Left	22	0	0	51		
Volume Right	0	49	9	0		
cSH	1623	1700	873	888		
Volume to Capacity	0.01	0.03	0.03	0.07		
Queue Length 95th (ft)	1	0	2	6		
Control Delay (s/veh)	7.2	0.0	9.2	9.4		
Lane LOS	A		A	A		
Approach Delay (s/veh)	2.2		9.2	9.4		
Approach LOS			A	A		
Intersection Summary						
Average Delay			6.2			
Intersection Capacity Utilization			20.0%	ICU Level of Service	A	
Analysis Period (min)			15			

Queues
3: M-291 & Oldham Parkway

























Existing Conditions Traffic Volumes
SAT Peak Hour



Lane Group	EBL	EBR	NBL	NBT	SBT	SBR
Lane Group Flow (vph)	45	17	13	1141	1086	56
v/c Ratio	0.20	0.03	0.06	0.25	0.25	0.04
Control Delay (s/veh)	48.1	0.1	47.4	2.0	3.2	0.0
Queue Delay	0.0	0.0	0.0	0.0	0.0	0.0
Total Delay (s/veh)	48.1	0.1	47.4	2.0	3.2	0.0
Queue Length 50th (ft)	14	0	4	54	51	0
Queue Length 95th (ft)	32	0	14	72	127	0
Internal Link Dist (ft)				1398	624	
Turn Bay Length (ft)			250			180
Base Capacity (vph)	418	587	418	4469	4332	1377
Starvation Cap Reductn	0	0	0	0	0	0
Spillback Cap Reductn	0	0	0	0	0	0
Storage Cap Reductn	0	0	0	0	0	0
Reduced v/c Ratio	0.11	0.03	0.03	0.26	0.25	0.04
Intersection Summary						

HCM 7th Signalized Intersection Summary
3: M-291 & Oldham Parkway

Existing Conditions Traffic Volumes
SAT Peak Hour

												
Movement	EBL	EBT	EBR	WBL	WBT	WBR	NBL	NBT	NBR	SBL	SBT	SBR
Lane Configurations												
Traffic Volume (veh/h)	42	0	16	0	0	0	12	1073	0	0	1021	53
Future Volume (veh/h)	42	0	16	0	0	0	12	1073	0	0	1021	53
Initial Q (Qb), veh	0	0	0	0	0	0	0	0	0	0	0	0
Lane Width Adj.	1.00	1.00	1.00	1.00	1.00	1.00	1.00	1.00	1.00	1.00	1.00	1.00
Ped-Bike Adj(A_pbT)	1.00		1.00	1.00		1.00	1.00		1.00	1.00		1.00
Parking Bus, Adj	1.00	1.00	1.00	1.00	1.00	1.00	1.00	1.00	1.00	1.00	1.00	1.00
Work Zone On Approach		No			No			No			No	
Adj Sat Flow, veh/h/ln	1870	1870	1870	1856	1870	1870	1870	1870	1870	1870	1870	1870
Adj Flow Rate, veh/h	45	0	0	0	0	0	13	1141	0	0	1086	0
Peak Hour Factor	0.94	0.94	0.94	0.94	0.94	0.94	0.94	0.94	0.94	0.94	0.94	0.94
Percent Heavy Veh, %	2	2	2	3	2	2	2	2	2	2	2	2
Cap, veh/h	120	69		3	2	2	52	4257		3	3830	
Arrive On Green	0.03	0.00	0.00	0.00	0.00	0.00	0.02	0.83	0.00	0.00	0.75	0.00
Sat Flow, veh/h	3456	1870	1585	3428	1870	1585	3456	5106	1585	3456	5106	1585
Grp Volume(v), veh/h	45	0	0	0	0	0	13	1141	0	0	1086	0
Grp Sat Flow(s),veh/h/ln	1728	1870	1585	1714	1870	1585	1728	1702	1585	1728	1702	1585
Q Serve(g_s), s	1.3	0.0	0.0	0.0	0.0	0.0	0.4	5.0	0.0	0.0	7.1	0.0
Cycle Q Clear(g_c), s	1.3	0.0	0.0	0.0	0.0	0.0	0.4	5.0	0.0	0.0	7.1	0.0
Prop In Lane	1.00		1.00	1.00		1.00	1.00		1.00	1.00		1.00
Lane Grp Cap(c), veh/h	120	69		3	2	2	52	4257		3	3830	
V/C Ratio(X)	0.37	0.00		0.00	0.00	0.00	0.25	0.27		0.00	0.28	
Avail Cap(c_a), veh/h	421	232		415	146	124	421	4257		438	3830	
HCM Platoon Ratio	1.00	1.00	1.00	1.00	1.00	1.00	1.00	1.00	1.00	1.00	1.00	1.00
Upstream Filter(I)	1.00	0.00	0.00	0.00	0.00	0.00	0.92	0.92	0.00	0.00	1.00	0.00
Uniform Delay (d), s/veh	49.6	0.0	0.0	0.0	0.0	0.0	51.1	1.9	0.0	0.0	4.2	0.0
Incr Delay (d2), s/veh	1.9	0.0	0.0	0.0	0.0	0.0	2.3	0.1	0.0	0.0	0.2	0.0
Initial Q Delay(d3), s/veh	0.0	0.0	0.0	0.0	0.0	0.0	0.0	0.0	0.0	0.0	0.0	0.0
%ile BackOfQ(95%),veh/ln	1.1	0.0	0.0	0.0	0.0	0.0	0.3	1.2	0.0	0.0	3.2	0.0
Unsig. Movement Delay, s/veh												
LnGrp Delay(d), s/veh	51.5	0.0	0.0	0.0	0.0	0.0	53.4	2.0	0.0	0.0	4.3	0.0
LnGrp LOS	D						D	A			A	
Approach Vol, veh/h		45			0			1154			1086	
Approach Delay, s/veh		51.5			0.0			2.6			4.3	
Approach LOS		D						A			A	
Timer - Assigned Phs	1	2	3	4	5	6	7	8				
Phs Duration (G+Y+Rc), s	0.0	94.1	0.0	10.9	8.8	85.4	10.9	0.0				
Change Period (Y+Rc), s	6.7	* 6.6	7.3	7.0	7.2	6.6	7.2	* 7				
Max Green Setting (Gmax), s	13.3	* 39	12.7	13.0	12.8	38.4	12.8	* 8.2				
Max Q Clear Time (g_c+I1), s	0.0	7.0	0.0	0.0	2.4	9.1	3.3	0.0				
Green Ext Time (p_c), s	0.0	12.4	0.0	0.0	0.0	11.4	0.1	0.0				
Intersection Summary												
HCM 7th Control Delay, s/veh			4.4									
HCM 7th LOS			A									
Notes												
User approved pedestrian interval to be less than phase max green.												
* HCM 7th computational engine requires equal clearance times for the phases crossing the barrier.												

Unsignalized Delay for [NBR, EBR, SBR] is excluded from calculations of the approach delay and intersection delay.

Queues
4: Jefferson Street & Persels Road





















Existing Conditions Traffic Volumes
SAT Peak Hour



Lane Group	EBL	EBT	WBL	WBT	NBL	NBT	SBL	SBT
Lane Group Flow (vph)	2	135	50	156	10	65	4	28
v/c Ratio	0.00	0.05	0.05	0.10	0.04	0.26	0.01	0.12
Control Delay (s/veh)	5.0	8.4	4.5	6.3	40.6	20.8	39.5	35.5
Queue Delay	0.0	0.0	0.0	0.0	0.0	0.0	0.0	0.0
Total Delay (s/veh)	5.0	8.4	4.5	6.3	40.6	20.8	39.5	35.5
Queue Length 50th (ft)	0	17	7	22	7	10	3	13
Queue Length 95th (ft)	3	41	26	94	20	53	12	41
Internal Link Dist (ft)		356		523		340		1357
Turn Bay Length (ft)	110		175		110		150	
Base Capacity (vph)	1071	2500	1033	1446	318	449	317	448
Starvation Cap Reductn	0	0	0	0	0	0	0	0
Spillback Cap Reductn	0	0	0	0	0	0	0	0
Storage Cap Reductn	0	0	0	0	0	0	0	0
Reduced v/c Ratio	0.00	0.05	0.05	0.11	0.03	0.14	0.01	0.06
Intersection Summary								

HCM 7th Signalized Intersection Summary
4: Jefferson Street & Persels Road

Existing Conditions Traffic Volumes
SAT Peak Hour

												
Movement	EBL	EBT	EBR	WBL	WBT	WBR	NBL	NBT	NBR	SBL	SBT	SBR
Lane Configurations												
Traffic Volume (veh/h)	2	124	3	47	138	8	9	14	47	4	17	9
Future Volume (veh/h)	2	124	3	47	138	8	9	14	47	4	17	9
Initial Q (Qb), veh	0	0	0	0	0	0	0	0	0	0	0	0
Lane Width Adj.	1.00	1.00	1.00	1.00	1.00	1.00	1.00	1.00	1.00	1.00	1.00	1.00
Ped-Bike Adj(A_pbT)	1.00		1.00	1.00		1.00	1.00		1.00	1.00		1.00
Parking Bus, Adj	1.00	1.00	1.00	1.00	1.00	1.00	1.00	1.00	1.00	1.00	1.00	1.00
Work Zone On Approach		No			No			No			No	
Adj Sat Flow, veh/h/ln	1870	1870	1870	1870	1870	1870	1870	1870	1870	1870	1870	1870
Adj Flow Rate, veh/h	2	132	3	50	147	9	10	15	50	4	18	10
Peak Hour Factor	0.94	0.94	0.94	0.94	0.94	0.94	0.94	0.94	0.94	0.94	0.94	0.94
Percent Heavy Veh, %	2	2	2	2	2	2	2	2	2	2	2	2
Cap, veh/h	835	2210	50	942	1194	73	248	51	168	209	136	75
Arrive On Green	0.01	0.62	0.62	0.07	0.68	0.68	0.02	0.13	0.13	0.01	0.12	0.12
Sat Flow, veh/h	1781	3552	81	1781	1744	107	1781	379	1264	1781	1130	628
Grp Volume(v), veh/h	2	66	69	50	0	156	10	0	65	4	0	28
Grp Sat Flow(s),veh/h/ln	1781	1777	1856	1781	0	1851	1781	0	1643	1781	0	1757
Q Serve(g_s), s	0.1	1.7	1.8	1.0	0.0	3.5	0.6	0.0	4.3	0.2	0.0	1.7
Cycle Q Clear(g_c), s	0.1	1.7	1.8	1.0	0.0	3.5	0.6	0.0	4.3	0.2	0.0	1.7
Prop In Lane	1.00		0.04	1.00		0.06	1.00		0.77	1.00		0.36
Lane Grp Cap(c), veh/h	835	1105	1154	942	0	1267	248	0	219	209	0	211
V/C Ratio(X)	0.00	0.06	0.06	0.05	0.00	0.12	0.04	0.00	0.30	0.02	0.00	0.13
Avail Cap(c_a), veh/h	1122	1105	1154	1119	0	1267	503	0	411	487	0	439
HCM Platoon Ratio	1.00	1.00	1.00	1.00	1.00	1.00	1.00	1.00	1.00	1.00	1.00	1.00
Upstream Filter(I)	1.00	1.00	1.00	0.98	0.00	0.98	1.00	0.00	1.00	1.00	0.00	1.00
Uniform Delay (d), s/veh	8.3	8.9	8.9	5.4	0.0	6.5	44.3	0.0	46.9	45.5	0.0	47.2
Incr Delay (d2), s/veh	0.0	0.1	0.1	0.0	0.0	0.2	0.1	0.0	1.6	0.1	0.0	0.6
Initial Q Delay(d3), s/veh	0.0	0.0	0.0	0.0	0.0	0.0	0.0	0.0	0.0	0.0	0.0	0.0
%ile BackOfQ(95%),veh/ln	0.0	1.2	1.3	0.6	0.0	2.4	0.5	0.0	3.3	0.2	0.0	1.4
Unsig. Movement Delay, s/veh												
LnGrp Delay(d), s/veh	8.3	9.0	9.0	5.4	0.0	6.7	44.3	0.0	48.5	45.5	0.0	47.8
LnGrp LOS	A	A	A	A		A	D		D	D		D
Approach Vol, veh/h		137			206			75				32
Approach Delay, s/veh		9.0			6.4			48.0				47.5
Approach LOS		A			A			D				D
Timer - Assigned Phs	1	2	3	4	5	6	7	8				
Phs Duration (G+Y+Rc), s	13.1	79.6	6.2	21.0	5.6	87.1	7.8	19.4				
Change Period (Y+Rc), s	5.0	5.0	5.0	5.0	5.0	5.0	5.0	5.0				
Max Green Setting (Gmax), s	20.0	30.0	20.0	30.0	20.0	30.0	20.0	30.0				
Max Q Clear Time (g_c+I1), s	3.0	3.8	2.2	6.3	2.1	5.5	2.6	3.7				
Green Ext Time (p_c), s	0.1	1.3	0.0	0.5	0.0	1.5	0.0	0.2				
Intersection Summary												
HCM 7th Control Delay, s/veh				17.0								
HCM 7th LOS				B								

Queues
5: M-291 & Persels Road/Bailey Road

Existing Conditions Traffic Volumes
SAT Peak Hour

























Lane Group	EBL	EBT	WBL	WBT	WBR	NBL	NBT	NBR	SBL	SBT	SBR
Lane Group Flow (vph)	127	138	119	70	40	26	1010	140	26	963	189
v/c Ratio	0.24	0.53	0.33	0.27	0.12	0.16	0.44	0.17	0.16	0.59	0.23
Control Delay (s/veh)	40.8	42.0	42.8	40.2	0.7	45.7	18.2	4.1	45.7	20.9	5.7
Queue Delay	0.0	0.0	0.0	0.0	0.0	0.0	0.0	0.0	0.0	0.0	0.0
Total Delay (s/veh)	40.8	42.0	42.8	40.2	0.7	45.7	18.2	4.1	45.7	20.9	5.7
Queue Length 50th (ft)	32	63	30	34	0	13	114	0	13	170	9
Queue Length 95th (ft)	73	142	69	85	0	45	229	38	45	354	59
Internal Link Dist (ft)		523		687			649			1398	
Turn Bay Length (ft)	200		280		290	310		350	330		
Base Capacity (vph)	955	505	1159	629	620	404	2679	900	407	1884	915
Starvation Cap Reductn	0	0	0	0	0	0	0	0	0	0	0
Spillback Cap Reductn	0	0	0	0	0	0	0	0	0	0	0
Storage Cap Reductn	0	0	0	0	0	0	0	0	0	0	0
Reduced v/c Ratio	0.13	0.27	0.10	0.11	0.06	0.06	0.38	0.16	0.06	0.51	0.21

Intersection Summary

HCM 7th Signalized Intersection Summary
5: M-291 & Persels Road/Bailey Road

Existing Conditions Traffic Volumes
SAT Peak Hour

												
Movement	EBL	EBT	EBR	WBL	WBT	WBR	NBL	NBT	NBR	SBL	SBT	SBR
Lane Configurations												
Traffic Volume (veh/h)	119	92	38	112	66	38	24	949	132	24	905	178
Future Volume (veh/h)	119	92	38	112	66	38	24	949	132	24	905	178
Initial Q (Qb), veh	0	0	0	0	0	0	0	0	0	0	0	0
Lane Width Adj.	1.00	1.00	1.00	1.00	1.00	1.00	1.00	1.00	1.00	1.00	1.00	1.00
Ped-Bike Adj(A_pbT)	1.00		1.00	1.00		1.00	1.00		1.00	1.00		1.00
Parking Bus, Adj	1.00	1.00	1.00	1.00	1.00	1.00	1.00	1.00	1.00	1.00	1.00	1.00
Work Zone On Approach		No			No			No			No	
Adj Sat Flow, veh/h/ln	1870	1870	1870	1870	1870	1870	1870	1870	1870	1870	1870	1870
Adj Flow Rate, veh/h	127	98	40	119	70	40	26	1010	0	26	963	0
Peak Hour Factor	0.94	0.94	0.94	0.94	0.94	0.94	0.94	0.94	0.94	0.94	0.94	0.94
Percent Heavy Veh, %	2	2	2	2	2	2	2	2	2	2	2	2
Cap, veh/h	290	136	56	287	202	171	69	2187		69	1518	
Arrive On Green	0.08	0.11	0.11	0.08	0.11	0.11	0.04	0.43	0.00	0.04	0.43	0.00
Sat Flow, veh/h	3456	1262	515	3456	1870	1585	1781	5106	1585	1781	3554	1585
Grp Volume(v), veh/h	127	0	138	119	70	40	26	1010	0	26	963	0
Grp Sat Flow(s),veh/h/ln	1728	0	1778	1728	1870	1585	1781	1702	1585	1781	1777	1585
Q Serve(g_s), s	2.7	0.0	5.9	2.6	2.7	1.8	1.1	11.0	0.0	1.1	16.6	0.0
Cycle Q Clear(g_c), s	2.7	0.0	5.9	2.6	2.7	1.8	1.1	11.0	0.0	1.1	16.6	0.0
Prop In Lane	1.00		0.29	1.00		1.00	1.00		1.00	1.00		1.00
Lane Grp Cap(c), veh/h	290	0	192	287	202	171	69	2187		69	1518	
V/C Ratio(X)	0.44	0.00	0.72	0.42	0.35	0.23	0.38	0.46		0.38	0.63	
Avail Cap(c_a), veh/h	1019	0	524	1236	549	465	432	2847		434	2005	
HCM Platoon Ratio	1.00	1.00	1.00	1.00	1.00	1.00	1.00	1.00	1.00	1.00	1.00	1.00
Upstream Filter(I)	1.00	0.00	1.00	1.00	1.00	1.00	1.00	1.00	0.00	1.00	1.00	0.00
Uniform Delay (d), s/veh	34.0	0.0	33.7	34.0	32.2	31.8	36.6	15.9	0.0	36.6	17.6	0.0
Incr Delay (d2), s/veh	1.0	0.0	5.0	1.0	1.0	0.7	3.4	0.6	0.0	3.4	1.6	0.0
Initial Q Delay(d3), s/veh	0.0	0.0	0.0	0.0	0.0	0.0	0.0	0.0	0.0	0.0	0.0	0.0
%ile BackOfQ(95%),veh/ln	2.1	0.0	4.8	1.9	2.2	1.3	0.9	6.9	0.0	0.9	10.2	0.0
Unsig. Movement Delay, s/veh												
LnGrp Delay(d), s/veh	35.0	0.0	38.7	34.9	33.3	32.5	40.0	16.4	0.0	40.0	19.2	0.0
LnGrp LOS	D		D	C	C	C	D	B		D	B	
Approach Vol, veh/h		265			229			1036			989	
Approach Delay, s/veh		36.9			34.0			17.0			19.7	
Approach LOS		D			C			B			B	
Timer - Assigned Phs	1	2	3	4	5	6	7	8				
Phs Duration (G+Y+Rc), s	9.0	39.9	13.6	15.5	9.1	39.8	13.6	15.5				
Change Period (Y+Rc), s	6.0	6.5	7.1	* 7.1	6.1	* 6.5	7.0	7.1				
Max Green Setting (Gmax), s	19.0	43.5	27.9	* 23	18.9	* 44	23.0	22.9				
Max Q Clear Time (g_c+I1), s	3.1	13.0	4.6	7.9	3.1	18.6	4.7	4.7				
Green Ext Time (p_c), s	0.0	16.8	0.3	0.6	0.0	14.7	0.3	0.4				
Intersection Summary												
HCM 7th Control Delay, s/veh			21.7									
HCM 7th LOS			C									
Notes												
* HCM 7th computational engine requires equal clearance times for the phases crossing the barrier.												
Unsignalized Delay for [NBR, SBR] is excluded from calculations of the approach delay and intersection delay.												

Queues
1: Ward Road & Oldham Parkway

Existing + Phase 1 Development Traffic Volumes

AM Peak Hour



Lane Group	EBL	EBT	WBT	NBL	NBT	SBL	SBT	SBR
Lane Group Flow (vph)	38	31	240	15	640	159	256	63
v/c Ratio	0.21	0.08	0.61	0.08	0.56	0.47	0.12	0.06
Control Delay (s/veh)	27.2	17.7	22.0	32.9	20.2	30.2	7.7	2.2
Queue Delay	0.0	0.0	0.0	0.0	0.0	0.0	0.0	0.0
Total Delay (s/veh)	27.2	17.7	22.0	32.9	20.2	30.2	7.7	2.2
Queue Length 50th (ft)	12	5	43	5	97	51	17	0
Queue Length 95th (ft)	43	29	134	26	192	133	62	15
Internal Link Dist (ft)		116	246		459		353	
Turn Bay Length (ft)				110		105		
Base Capacity (vph)	500	971	918	246	2553	782	3256	1463
Starvation Cap Reductn	0	0	0	0	0	0	0	0
Spillback Cap Reductn	0	0	0	0	0	0	0	0
Storage Cap Reductn	0	0	0	0	0	0	0	0
Reduced v/c Ratio	0.08	0.03	0.26	0.06	0.25	0.20	0.08	0.04

Intersection Summary

HCM 7th Signalized Intersection Summary Existing + Phase 1 Development Traffic Volumes
 1: Ward Road & Oldham Parkway AM Peak Hour



Movement	EBL	EBT	EBR	WBL	WBT	WBR	NBL	NBT	NBR	SBL	SBT	SBR	
Lane Configurations													
Traffic Volume (veh/h)	35	17	12	35	28	160	14	556	39	148	238	59	
Future Volume (veh/h)	35	17	12	35	28	160	14	556	39	148	238	59	
Initial Q (Qb), veh	0	0	0	0	0	0	0	0	0	0	0	0	
Lane Width Adj.	1.00	1.00	1.00	1.00	1.00	1.00	1.00	1.00	1.00	1.00	1.00	1.00	
Ped-Bike Adj(A_pbT)	1.00		1.00	1.00		1.00	1.00		1.00	1.00		1.00	
Parking Bus, Adj	1.00	1.00	1.00	1.00	1.00	1.00	1.00	1.00	1.00	1.00	1.00	1.00	
Work Zone On Approach		No			No			No			No		
Adj Sat Flow, veh/h/ln	1870	1870	1870	1870	1870	1870	1870	1870	1870	1870	1870	1870	
Adj Flow Rate, veh/h	38	18	13	38	30	172	15	598	42	159	256	63	
Peak Hour Factor	0.93	0.93	0.93	0.93	0.93	0.93	0.93	0.93	0.93	0.93	0.93	0.93	
Percent Heavy Veh, %	2	2	2	2	2	2	2	2	2	2	2	2	
Cap, veh/h	376	207	150	118	61	237	34	1063	75	213	1479	660	
Arrive On Green	0.21	0.21	0.21	0.21	0.21	0.21	0.02	0.32	0.32	0.12	0.42	0.42	
Sat Flow, veh/h	1180	1010	729	158	297	1151	1781	3368	236	1781	3554	1585	
Grp Volume(v), veh/h	38	0	31	240	0	0	15	315	325	159	256	63	
Grp Sat Flow(s),veh/h/ln	1180	0	1739	1607	0	0	1781	1777	1828	1781	1777	1585	
Q Serve(g_s), s	0.0	0.0	0.7	3.0	0.0	0.0	0.4	7.2	7.2	4.2	2.2	1.2	
Cycle Q Clear(g_c), s	1.4	0.0	0.7	6.7	0.0	0.0	0.4	7.2	7.2	4.2	2.2	1.2	
Prop In Lane	1.00		0.42	0.16		0.72	1.00		0.13	1.00		1.00	
Lane Grp Cap(c), veh/h	376	0	357	416	0	0	34	561	577	213	1479	660	
V/C Ratio(X)	0.10	0.00	0.09	0.58	0.00	0.00	0.45	0.56	0.56	0.75	0.17	0.10	
Avail Cap(c_a), veh/h	931	0	1175	1158	0	0	304	1580	1626	962	4474	1996	
HCM Platoon Ratio	1.00	1.00	1.00	1.00	1.00	1.00	1.00	1.00	1.00	1.00	1.00	1.00	
Upstream Filter(I)	1.00	0.00	1.00	1.00	0.00	0.00	1.00	1.00	1.00	1.00	1.00	1.00	
Uniform Delay (d), s/veh	15.9	0.0	15.6	18.0	0.0	0.0	23.6	13.9	13.9	20.7	8.9	8.6	
Incr Delay (d2), s/veh	0.1	0.0	0.1	1.3	0.0	0.0	9.0	1.3	1.2	5.2	0.1	0.1	
Initial Q Delay(d3), s/veh	0.0	0.0	0.0	0.0	0.0	0.0	0.0	0.0	0.0	0.0	0.0	0.0	
%ile BackOfQ(95%),veh/ln	0.6	0.0	0.5	4.1	0.0	0.0	0.4	4.6	4.7	3.3	1.2	0.6	
Unsig. Movement Delay, s/veh													
LnGrp Delay(d), s/veh	16.0	0.0	15.8	19.3	0.0	0.0	32.6	15.1	15.1	25.9	9.0	8.7	
LnGrp LOS	B		B	B			C	B	B	C	A	A	
Approach Vol, veh/h	69						240		655		478		
Approach Delay, s/veh	15.9						19.3		15.5		14.6		
Approach LOS	B						B		B		B		
Timer - Assigned Phs	1	2	4		5	6	8						
Phs Duration (G+Y+Rc), s	6.6	26.0	16.1		11.5	21.1	16.1						
Change Period (Y+Rc), s	5.7	5.7	6.1		5.7	5.7	6.1						
Max Green Setting (Gmax), s	8.3	61.3	32.9		26.3	43.3	32.9						
Max Q Clear Time (g_c+I1), s	2.4	4.2	8.7		6.2	9.2	3.4						
Green Ext Time (p_c), s	0.0	2.9	1.4		0.4	6.2	0.3						

Intersection Summary												
HCM 7th Control Delay, s/veh			15.9									
HCM 7th LOS			B									

Notes
 User approved pedestrian interval to be less than phase max green.

HCM 7th TWSC
2: Jefferson Street & Oldham Parkway

Existing + Phase 1 Development Traffic Volumes
AM Peak Hour

Intersection												
Int Delay, s/veh	1.7											
Movement	EBL	EBT	EBR	WBL	WBT	WBR	NBL	NBT	NBR	SBL	SBT	SBR
Lane Configurations	↗	↗↘		↗	↗↘				↗			↗
Traffic Vol, veh/h	3	523	38	181	403	323	0	0	84	0	0	2
Future Vol, veh/h	3	523	38	181	403	323	0	0	84	0	0	2
Conflicting Peds, #/hr	0	0	0	0	0	0	0	0	0	0	0	0
Sign Control	Free	Free	Free	Free	Free	Free	Stop	Stop	Stop	Stop	Stop	Stop
RT Channelized	-	-	None	-	-	None	-	-	None	-	-	None
Storage Length	150	-	-	200	-	-	-	-	0	-	-	0
Veh in Median Storage, #	-	0	-	-	0	-	-	0	-	-	0	-
Grade, %	-	0	-	-	0	-	-	0	-	-	0	-
Peak Hour Factor	93	93	93	93	93	93	93	93	93	93	93	93
Heavy Vehicles, %	2	2	2	2	4	2	2	2	2	2	2	2
Mvmt Flow	3	562	41	195	433	347	0	0	90	0	0	2

Major/Minor	Major1			Major2			Minor1			Minor2		
Conflicting Flow All	781	0	0	603	0	0	-	-	302	-	-	390
Stage 1	-	-	-	-	-	-	-	-	-	-	-	-
Stage 2	-	-	-	-	-	-	-	-	-	-	-	-
Critical Hdwy	4.14	-	-	4.14	-	-	-	-	6.94	-	-	6.94
Critical Hdwy Stg 1	-	-	-	-	-	-	-	-	-	-	-	-
Critical Hdwy Stg 2	-	-	-	-	-	-	-	-	-	-	-	-
Follow-up Hdwy	2.22	-	-	2.22	-	-	-	-	3.32	-	-	3.32
Pot Cap-1 Maneuver	833	-	-	970	-	-	0	0	694	0	0	608
Stage 1	-	-	-	-	-	-	0	0	-	0	0	-
Stage 2	-	-	-	-	-	-	0	0	-	0	0	-
Platoon blocked, %		-	-		-	-				-	-	
Mov Cap-1 Maneuver	833	-	-	970	-	-	-	-	694	-	-	608
Mov Cap-2 Maneuver	-	-	-	-	-	-	-	-	-	-	-	-
Stage 1	-	-	-	-	-	-	-	-	-	-	-	-
Stage 2	-	-	-	-	-	-	-	-	-	-	-	-

Approach	EB			WB			NB			SB		
HCM Control Delay, s/v	0.05			1.92			10.96			10.94		
HCM LOS							B			B		

Minor Lane/Major Mvmt	NBLn1	EBL	EBT	EBR	WBL	WBT	WBR	SBLn1
Capacity (veh/h)	694	833	-	-	970	-	-	608
HCM Lane V/C Ratio	0.13	0.004	-	-	0.201	-	-	0.004
HCM Control Delay (s/veh)	11	9.3	-	-	9.6	-	-	10.9
HCM Lane LOS	B	A	-	-	A	-	-	B
HCM 95th %tile Q(veh)	0.4	0	-	-	0.7	-	-	0

Queues
3: M-291 & Oldham Parkway

Existing + Phase 1 Development Traffic Volumes
AM Peak Hour



Lane Group	EBL	EBR	NBL	NBT	SBT	SBR
Lane Group Flow (vph)	394	257	317	1578	1269	618
v/c Ratio	0.75	0.52	0.68	0.42	0.46	0.56
Control Delay (s/veh)	57.9	6.6	45.3	8.9	18.6	5.2
Queue Delay	0.0	0.0	0.0	0.0	0.0	0.0
Total Delay (s/veh)	57.9	6.6	45.3	8.9	18.6	5.2
Queue Length 50th (ft)	151	0	118	164	215	32
Queue Length 95th (ft)	202	44	169	288	286	128
Internal Link Dist (ft)				613	988	
Turn Bay Length (ft)	345		250			180
Base Capacity (vph)	597	537	531	3726	2727	1095
Starvation Cap Reductn	0	0	0	0	0	0
Spillback Cap Reductn	0	0	0	0	0	0
Storage Cap Reductn	0	0	0	0	0	0
Reduced v/c Ratio	0.66	0.48	0.60	0.42	0.47	0.56
Intersection Summary						

HCM 7th Signalized Intersection Summary Existing + Phase 1 Development Traffic Volumes
 3: M-291 & Oldham Parkway AM Peak Hour

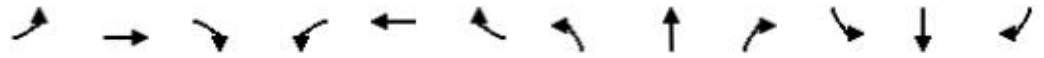

Movement	EBL	EBT	EBR	WBL	WBT	WBR	NBL	NBT	NBR	SBL	SBT	SBR
Lane Configurations	↔↔	↑	↗	↔↔	↑	↗	↔↔	↑↑↑	↗	↔↔	↑↑↑	↗
Traffic Volume (veh/h)	366	0	239	0	0	0	295	1468	0	0	1180	575
Future Volume (veh/h)	366	0	239	0	0	0	295	1468	0	0	1180	575
Initial Q (Qb), veh	0	0	0	0	0	0	0	0	0	0	0	0
Lane Width Adj.	1.00	1.00	1.00	1.00	1.00	1.00	1.00	1.00	1.00	1.00	1.00	1.00
Ped-Bike Adj(A_pbT)	1.00		1.00	1.00		1.00	1.00		1.00	1.00		1.00
Parking Bus, Adj	1.00	1.00	1.00	1.00	1.00	1.00	1.00	1.00	1.00	1.00	1.00	1.00
Work Zone On Approach		No			No			No			No	
Adj Sat Flow, veh/h/ln	1870	1870	1870	1856	1870	1870	1870	1870	1870	1870	1870	1870
Adj Flow Rate, veh/h	394	0	0	0	0	0	317	1578	0	0	1269	0
Peak Hour Factor	0.93	0.93	0.93	0.93	0.93	0.93	0.93	0.93	0.93	0.93	0.93	0.93
Percent Heavy Veh, %	2	2	2	3	2	2	2	2	2	2	2	2
Cap, veh/h	464	254		3	2	1	376	3833		3	2971	
Arrive On Green	0.13	0.00	0.00	0.00	0.00	0.00	0.22	1.00	0.00	0.00	0.58	0.00
Sat Flow, veh/h	3456	1870	1585	3428	1870	1585	3456	5106	1585	3456	5106	1585
Grp Volume(v), veh/h	394	0	0	0	0	0	317	1578	0	0	1269	0
Grp Sat Flow(s),veh/h/ln	1728	1870	1585	1714	1870	1585	1728	1702	1585	1728	1702	1585
Q Serve(g_s), s	13.4	0.0	0.0	0.0	0.0	0.0	10.5	0.0	0.0	0.0	16.6	0.0
Cycle Q Clear(g_c), s	13.4	0.0	0.0	0.0	0.0	0.0	10.5	0.0	0.0	0.0	16.6	0.0
Prop In Lane	1.00		1.00	1.00		1.00	1.00		1.00	1.00		1.00
Lane Grp Cap(c), veh/h	464	254		3	2	1	376	3833		3	2971	
V/C Ratio(X)	0.85	0.00		0.00	0.00	0.00	0.84	0.41		0.00	0.43	
Avail Cap(c_a), veh/h	602	352		143	109	92	521	3833		144	2971	
HCM Platoon Ratio	1.00	1.00	1.00	1.00	1.00	1.00	2.00	2.00	2.00	1.00	1.00	1.00
Upstream Filter(I)	1.00	0.00	0.00	0.00	0.00	0.00	1.00	1.00	0.00	0.00	1.00	0.00
Uniform Delay (d), s/veh	50.8	0.0	0.0	0.0	0.0	0.0	45.9	0.0	0.0	0.0	14.0	0.0
Incr Delay (d2), s/veh	8.9	0.0	0.0	0.0	0.0	0.0	8.8	0.3	0.0	0.0	0.5	0.0
Initial Q Delay(d3), s/veh	0.0	0.0	0.0	0.0	0.0	0.0	0.0	0.0	0.0	0.0	0.0	0.0
%ile BackOfQ(95%),veh/ln	10.5	0.0	0.0	0.0	0.0	0.0	7.9	0.2	0.0	0.0	10.0	0.0
Unsig. Movement Delay, s/veh												
LnGrp Delay(d), s/veh	59.6	0.0	0.0	0.0	0.0	0.0	54.7	0.3	0.0	0.0	14.4	0.0
LnGrp LOS	E						D	A			B	
Approach Vol, veh/h		394			0			1895			1269	
Approach Delay, s/veh		59.6			0.0			9.4			14.4	
Approach LOS		E						A			B	
Timer - Assigned Phs	1	2	3	4	5	6	7	8				
Phs Duration (G+Y+Rc), s	0.0	96.7	0.0	23.3	20.3	76.4	23.3	0.0				
Change Period (Y+Rc), s	6.7	* 6.6	7.3	7.0	7.2	6.6	7.2	* 7				
Max Green Setting (Gmax), s	5.0	* 60	5.0	22.6	18.1	46.2	20.9	* 7				
Max Q Clear Time (g_c+I1), s	0.0	2.0	0.0	0.0	12.5	18.6	15.4	0.0				
Green Ext Time (p_c), s	0.0	24.9	0.0	0.0	0.5	13.3	0.7	0.0				

Intersection Summary												
HCM 7th Control Delay, s/veh											16.8	
HCM 7th LOS											B	

Notes
 * HCM 7th computational engine requires equal clearance times for the phases crossing the barrier.
 Unsignalized Delay for [NBR, EBR, SBR] is excluded from calculations of the approach delay and intersection delay.

Queues
4: Jefferson Street & Persels Road

Existing + Phase 1 Development Traffic Volumes

AM Peak Hour



Lane Group	EBL	EBT	WBL	WBT	NBL	NBT	SBL	SBT
Lane Group Flow (vph)	4	291	313	257	16	260	14	208
v/c Ratio	0.00	0.15	0.40	0.20	0.06	0.63	0.06	0.65
Control Delay (s/veh)	11.0	18.1	7.0	7.7	30.8	25.8	30.7	54.9
Queue Delay	0.0	0.0	0.0	0.0	0.0	0.0	0.0	0.0
Total Delay (s/veh)	11.0	18.1	7.0	7.7	30.8	25.8	30.7	54.9
Queue Length 50th (ft)	1	48	11	9	11	77	9	150
Queue Length 95th (ft)	6	119	167	170	24	158	22	218
Internal Link Dist (ft)		1243		101		881		315
Turn Bay Length (ft)	110		175		110		150	
Base Capacity (vph)	731	1822	830	1225	235	561	206	508
Starvation Cap Reductn	0	0	0	0	0	0	0	0
Spillback Cap Reductn	0	0	0	0	0	0	0	0
Storage Cap Reductn	0	0	0	0	0	0	0	0
Reduced v/c Ratio	0.01	0.16	0.38	0.21	0.07	0.46	0.07	0.41
Intersection Summary								

HCM 7th Signalized Intersection Summary
4: Jefferson Street & Persels Road

Existing + Phase 1 Development Traffic Volumes

AM Peak Hour



Movement	EBL	EBT	EBR	WBL	WBT	WBR	NBL	NBT	NBR	SBL	SBT	SBR
Lane Configurations	↗	↗↘		↗	↘		↗	↘		↗	↘	
Traffic Volume (veh/h)	4	238	33	291	220	19	15	52	190	13	179	15
Future Volume (veh/h)	4	238	33	291	220	19	15	52	190	13	179	15
Initial Q (Qb), veh	0	0	0	0	0	0	0	0	0	0	0	0
Lane Width Adj.	1.00	1.00	1.00	1.00	1.00	1.00	1.00	1.00	1.00	1.00	1.00	1.00
Ped-Bike Adj(A_pbT)	1.00		1.00	1.00		1.00	1.00		1.00	1.00		1.00
Parking Bus, Adj	1.00	1.00	1.00	1.00	1.00	1.00	1.00	1.00	1.00	1.00	1.00	1.00
Work Zone On Approach		No			No			No			No	
Adj Sat Flow, veh/h/ln	1870	1870	1870	1870	1870	1752	1870	1870	1870	1870	1870	1870
Adj Flow Rate, veh/h	4	256	35	313	237	20	16	56	204	14	192	16
Peak Hour Factor	0.93	0.93	0.93	0.93	0.93	0.93	0.93	0.93	0.93	0.93	0.93	0.93
Percent Heavy Veh, %	2	2	2	2	2	10	2	2	2	2	2	2
Cap, veh/h	651	1604	217	754	1028	87	216	66	241	154	313	26
Arrive On Green	0.01	0.51	0.51	0.10	0.60	0.60	0.03	0.19	0.19	0.03	0.18	0.18
Sat Flow, veh/h	1781	3146	425	1781	1701	144	1781	353	1286	1781	1703	142
Grp Volume(v), veh/h	4	143	148	313	0	257	16	0	260	14	0	208
Grp Sat Flow(s),veh/h/ln	1781	1777	1794	1781	0	1845	1781	0	1639	1781	0	1845
Q Serve(g_s), s	0.1	5.2	5.3	9.4	0.0	7.7	0.9	0.0	18.4	0.7	0.0	12.4
Cycle Q Clear(g_c), s	0.1	5.2	5.3	9.4	0.0	7.7	0.9	0.0	18.4	0.7	0.0	12.4
Prop In Lane	1.00		0.24	1.00		0.08	1.00		0.78	1.00		0.08
Lane Grp Cap(c), veh/h	651	906	915	754	0	1115	216	0	307	154	0	339
V/C Ratio(X)	0.01	0.16	0.16	0.42	0.00	0.23	0.07	0.00	0.85	0.09	0.00	0.61
Avail Cap(c_a), veh/h	781	906	915	909	0	1115	303	0	451	247	0	507
HCM Platoon Ratio	1.00	1.00	1.00	1.00	1.00	1.00	1.00	1.00	1.00	1.00	1.00	1.00
Upstream Filter(I)	1.00	1.00	1.00	1.00	0.00	1.00	1.00	0.00	1.00	1.00	0.00	1.00
Uniform Delay (d), s/veh	13.8	15.7	15.7	10.2	0.0	10.9	37.6	0.0	47.1	38.6	0.0	45.0
Incr Delay (d2), s/veh	0.0	0.4	0.4	0.5	0.0	0.5	0.2	0.0	14.6	0.4	0.0	3.8
Initial Q Delay(d3), s/veh	0.0	0.0	0.0	0.0	0.0	0.0	0.0	0.0	0.0	0.0	0.0	0.0
%ile BackOfQ(95%),veh/ln	0.1	3.9	4.0	6.4	0.0	5.7	0.7	0.0	13.5	0.6	0.0	10.0
Unsig. Movement Delay, s/veh												
LnGrp Delay(d), s/veh	13.8	16.0	16.1	10.7	0.0	11.4	37.8	0.0	61.7	39.0	0.0	48.8
LnGrp LOS	B	B	B	B		B	D		E	D		D
Approach Vol, veh/h		295			570			276			222	
Approach Delay, s/veh		16.0			11.0			60.3			48.2	
Approach LOS		B			B			E			D	
Timer - Assigned Phs	1	2	3	4	5	6	7	8				
Phs Duration (G+Y+Rc), s	17.6	66.2	8.7	27.5	6.2	77.5	9.1	27.1				
Change Period (Y+Rc), s	5.0	5.0	5.0	5.0	5.0	5.0	5.0	5.0				
Max Green Setting (Gmax), s	23.0	34.0	10.0	33.0	10.0	47.0	10.0	33.0				
Max Q Clear Time (g_c+I1), s	11.4	7.3	2.7	20.4	2.1	9.7	2.9	14.4				
Green Ext Time (p_c), s	1.2	3.2	0.0	2.1	0.0	3.1	0.0	1.9				
Intersection Summary												
HCM 7th Control Delay, s/veh			28.1									
HCM 7th LOS			C									

Queues
5: M-291 & Persels Road/Bailey Road

Existing + Phase 1 Development Traffic Volumes

AM Peak Hour



Lane Group	EBL	EBT	WBL	WBT	WBR	NBL	NBT	NBR	SBL	SBT	SBR
Lane Group Flow (vph)	349	124	187	134	71	45	1615	288	53	1105	461
v/c Ratio	0.74	0.42	0.60	0.65	0.23	0.38	0.65	0.31	0.45	0.64	0.45
Control Delay (s/veh)	64.2	43.3	61.2	65.8	1.7	63.2	26.3	3.3	76.0	16.1	2.2
Queue Delay	0.0	0.0	0.0	0.0	0.0	0.0	0.0	0.0	0.0	0.0	0.0
Total Delay (s/veh)	64.2	43.3	61.2	65.8	1.7	63.2	26.3	3.3	76.0	16.1	2.2
Queue Length 50th (ft)	134	84	72	100	0	34	366	0	43	153	1
Queue Length 95th (ft)	197	119	111	165	0	74	435	51	88	187	20
Internal Link Dist (ft)		341		1903			2201			705	
Turn Bay Length (ft)	200		280		290	310		350	330		
Base Capacity (vph)	514	342	331	246	338	126	2477	918	121	1718	1009
Starvation Cap Reductn	0	0	0	0	0	0	0	0	0	0	0
Spillback Cap Reductn	0	0	0	0	0	0	0	0	0	0	0
Storage Cap Reductn	0	0	0	0	0	0	0	0	0	0	0
Reduced v/c Ratio	0.68	0.36	0.56	0.54	0.21	0.36	0.65	0.31	0.44	0.64	0.46

Intersection Summary

HCM 7th Signalized Intersection Summary Existing + Phase 1 Development Traffic Volumes
 5: M-291 & Persels Road/Bailey Road AM Peak Hour

Movement	EBL	EBT	EBR	WBL	WBT	WBR	NBL	NBT	NBR	SBL	SBT	SBR
Lane Configurations												
Traffic Volume (veh/h)	325	91	24	174	125	66	42	1502	268	49	1028	429
Future Volume (veh/h)	325	91	24	174	125	66	42	1502	268	49	1028	429
Initial Q (Qb), veh	0	0	0	0	0	0	0	0	0	0	0	0
Lane Width Adj.	1.00	1.00	1.00	1.00	1.00	1.00	1.00	1.00	1.00	1.00	1.00	1.00
Ped-Bike Adj(A_pbT)	1.00		1.00	1.00		1.00	1.00		1.00	1.00		1.00
Parking Bus, Adj	1.00	1.00	1.00	1.00	1.00	1.00	1.00	1.00	1.00	1.00	1.00	1.00
Work Zone On Approach		No			No			No			No	
Adj Sat Flow, veh/h/ln	1870	1870	1841	1870	1870	1856	1870	1870	1870	1870	1856	1870
Adj Flow Rate, veh/h	349	98	26	187	134	71	45	1615	0	53	1105	0
Peak Hour Factor	0.93	0.93	0.93	0.93	0.93	0.93	0.93	0.93	0.93	0.93	0.93	0.93
Percent Heavy Veh, %	2	2	4	2	2	3	2	2	2	2	3	2
Cap, veh/h	414	196	52	246	169	142	81	2656		86	1842	
Arrive On Green	0.12	0.14	0.14	0.07	0.09	0.09	0.05	0.52	0.00	0.10	1.00	0.00
Sat Flow, veh/h	3456	1424	378	3456	1870	1572	1781	5106	1585	1781	3526	1585
Grp Volume(v), veh/h	349	0	124	187	134	71	45	1615	0	53	1105	0
Grp Sat Flow(s),veh/h/ln	1728	0	1802	1728	1870	1572	1781	1702	1585	1781	1763	1585
Q Serve(g_s), s	11.9	0.0	7.6	6.4	8.4	5.2	3.0	26.6	0.0	3.4	0.0	0.0
Cycle Q Clear(g_c), s	11.9	0.0	7.6	6.4	8.4	5.2	3.0	26.6	0.0	3.4	0.0	0.0
Prop In Lane	1.00		0.21	1.00		1.00	1.00		1.00	1.00		1.00
Lane Grp Cap(c), veh/h	414	0	248	246	169	142	81	2656		86	1842	
V/C Ratio(X)	0.84	0.00	0.50	0.76	0.80	0.50	0.56	0.61		0.62	0.60	
Avail Cap(c_a), veh/h	518	0	335	334	248	208	128	2656		119	1842	
HCM Platoon Ratio	1.00	1.00	1.00	1.00	1.00	1.00	1.00	1.00	1.00	2.00	2.00	2.00
Upstream Filter(I)	1.00	0.00	1.00	1.00	1.00	1.00	1.00	1.00	0.00	1.00	1.00	0.00
Uniform Delay (d), s/veh	51.7	0.0	47.9	54.7	53.5	52.0	56.1	20.2	0.0	53.1	0.0	0.0
Incr Delay (d2), s/veh	10.0	0.0	1.5	6.8	10.4	2.7	5.9	1.0	0.0	6.9	1.5	0.0
Initial Q Delay(d3), s/veh	0.0	0.0	0.0	0.0	0.0	0.0	0.0	0.0	0.0	0.0	0.0	0.0
%ile BackOfQ(95%),veh/ln	9.6	0.0	6.3	5.4	7.9	3.8	2.6	15.2	0.0	2.9	0.7	0.0
Unsig. Movement Delay, s/veh												
LnGrp Delay(d), s/veh	61.8	0.0	49.4	61.5	63.9	54.7	62.0	21.2	0.0	60.1	1.5	0.0
LnGrp LOS	E		D	E	E	D	E	C		E	A	
Approach Vol, veh/h		473			392			1660			1158	
Approach Delay, s/veh		58.5			61.1			22.4			4.1	
Approach LOS		E			E			C			A	
Timer - Assigned Phs	1	2	3	4	5	6	7	8				
Phs Duration (G+Y+Rc), s	11.8	68.9	15.6	23.6	11.5	69.2	21.4	17.9				
Change Period (Y+Rc), s	6.0	6.5	7.1	* 7.1	6.1	* 6.5	7.0	7.1				
Max Green Setting (Gmax), s	8.0	51.5	11.6	* 22	8.6	* 51	18.0	15.9				
Max Q Clear Time (g_c+I1), s	5.4	28.6	8.4	9.6	5.0	2.0	13.9	10.4				
Green Ext Time (p_c), s	0.0	19.6	0.2	0.4	0.0	25.3	0.5	0.4				

Intersection Summary												
HCM 7th Control Delay, s/veh			25.4									
HCM 7th LOS			C									

Notes
 * HCM 7th computational engine requires equal clearance times for the phases crossing the barrier.
 Unsignalized Delay for [NBR, SBR] is excluded from calculations of the approach delay and intersection delay.

Intersection						
Int Delay, s/veh	0.3					
Movement	EBL	EBR	NBL	NBT	SBT	SBR
Lane Configurations		↗		↕	↕	
Traffic Vol, veh/h	0	21	0	405	543	0
Future Vol, veh/h	0	21	0	405	543	0
Conflicting Peds, #/hr	12	0	0	0	0	0
Sign Control	Stop	Stop	Free	Free	Free	Free
RT Channelized	-	None	-	None	-	None
Storage Length	-	0	-	-	-	-
Veh in Median Storage, #	0	-	-	0	0	-
Grade, %	0	-	-	0	0	-
Peak Hour Factor	93	93	93	93	93	93
Heavy Vehicles, %	2	2	2	2	2	2
Mvmt Flow	0	23	0	435	584	0

Major/Minor	Minor2	Major1	Major2		
Conflicting Flow All	-	584	-	0	-
Stage 1	-	-	-	-	-
Stage 2	-	-	-	-	-
Critical Hdwy	-	6.23	-	-	-
Critical Hdwy Stg 1	-	-	-	-	-
Critical Hdwy Stg 2	-	-	-	-	-
Follow-up Hdwy	-	3.319	-	-	-
Pot Cap-1 Maneuver	0	511	0	-	-
Stage 1	0	-	0	-	-
Stage 2	0	-	0	-	-
Platoon blocked, %				-	-
Mov Cap-1 Maneuver	-	511	-	-	-
Mov Cap-2 Maneuver	-	-	-	-	-
Stage 1	-	-	-	-	-
Stage 2	-	-	-	-	-

Approach	EB	NB	SB
HCM Control Delay, s/v12.38		0	0
HCM LOS	B		

Minor Lane/Major Mvmt	NBT EBLn1	SBT
Capacity (veh/h)	- 511	-
HCM Lane V/C Ratio	- 0.044	-
HCM Control Delay (s/veh)	- 12.4	-
HCM Lane LOS	- B	-
HCM 95th %tile Q(veh)	- 0.1	-

HCM 7th TWSC
7: Oldham Parkway & Access 2

Existing + Full Development Traffic Volumes
AM Peak Hour

Intersection												
Int Delay, s/veh	46.1											
Movement	EBL	EBT	EBR	WBL	WBT	WBR	NBL	NBT	NBR	SBL	SBT	SBR
Lane Configurations	↖	↗		↖	↗		↖	↗	↖	↗	↖	↗
Traffic Vol, veh/h	17	20	84	301	20	4	132	241	32	5	177	21
Future Vol, veh/h	17	20	84	301	20	4	132	241	32	5	177	21
Conflicting Peds, #/hr	0	0	0	0	0	0	0	0	0	0	0	0
Sign Control	Stop	Stop	Stop	Stop	Stop	Stop	Free	Free	Free	Free	Free	Free
RT Channelized	-	-	None	-	-	None	-	-	None	-	-	None
Storage Length	0	-	-	0	-	-	150	-	0	100	-	-
Veh in Median Storage, #	-	0	-	-	0	-	-	0	-	-	0	-
Grade, %	-	0	-	-	0	-	-	0	-	-	0	-
Peak Hour Factor	98	98	98	98	98	98	98	98	98	98	98	98
Heavy Vehicles, %	2	2	2	2	2	2	2	2	2	2	2	2
Mvmt Flow	17	20	86	307	20	4	135	246	33	5	181	21

Major/Minor	Minor2		Minor1		Major1		Major2					
Conflicting Flow All	727	749	191	716	728	246	202	0	0	279	0	0
Stage 1	202	202	-	515	515	-	-	-	-	-	-	-
Stage 2	526	548	-	201	212	-	-	-	-	-	-	-
Critical Hdwy	7.12	6.52	6.22	7.12	6.52	6.22	4.12	-	-	4.12	-	-
Critical Hdwy Stg 1	6.12	5.52	-	6.12	5.52	-	-	-	-	-	-	-
Critical Hdwy Stg 2	6.12	5.52	-	6.12	5.52	-	-	-	-	-	-	-
Follow-up Hdwy	3.518	4.018	3.318	3.518	4.018	3.318	2.218	-	-	2.218	-	-
Pot Cap-1 Maneuver	339	340	850	345	350	793	1370	-	-	1284	-	-
Stage 1	800	735	-	542	535	-	-	-	-	-	-	-
Stage 2	536	517	-	801	727	-	-	-	-	-	-	-
Platoon blocked, %								-	-	-	-	-
Mov Cap-1 Maneuver	285	306	850	~ 262	315	793	1370	-	-	1284	-	-
Mov Cap-2 Maneuver	285	306	-	~ 262	315	-	-	-	-	-	-	-
Stage 1	797	732	-	489	482	-	-	-	-	-	-	-
Stage 2	460	466	-	697	724	-	-	-	-	-	-	-

Approach	EB	WB	NB	SB
HCM Control Delay, s/v12.75		141.36	2.58	0.19
HCM LOS	B	F		

Minor Lane/Major Mvmt	NBL	NBT	NBR	EBLn1	EBLn2	WBLn1	WBLn2	SBL	SBT	SBR
Capacity (veh/h)	1370	-	-	285	633	262	350	1284	-	-
HCM Lane V/C Ratio	0.098	-	-	0.061	0.168	1.173	0.07	0.004	-	-
HCM Control Delay (s/veh)	7.9	-	-	18.4	11.8	151.4	16.1	7.8	-	-
HCM Lane LOS	A	-	-	C	B	F	C	A	-	-
HCM 95th %tile Q(veh)	0.3	-	-	0.2	0.6	13.9	0.2	0	-	-

Notes
 -: Volume exceeds capacity \$: Delay exceeds 300s +: Computation Not Defined *: All major volume in platoon

HCM 7th TWSC
8: Oldham Parkway & Access 3

Existing + Phase 1 Development Traffic Volumes
AM Peak Hour

Intersection												
Int Delay, s/veh	2.7											
Movement	EBL	EBT	EBR	WBL	WBT	WBR	NBL	NBT	NBR	SBL	SBT	SBR
Lane Configurations		+			+		↑	↓			+	
Traffic Vol, veh/h	8	2	32	39	2	2	37	178	47	3	113	11
Future Vol, veh/h	8	2	32	39	2	2	37	178	47	3	113	11
Conflicting Peds, #/hr	0	0	0	0	0	0	0	0	0	0	0	0
Sign Control	Stop	Stop	Stop	Stop	Stop	Stop	Free	Free	Free	Free	Free	Free
RT Channelized	-	-	None	-	-	None	-	-	None	-	-	None
Storage Length	-	-	-	-	-	-	150	-	-	-	-	-
Veh in Median Storage, #	-	0	-	-	0	-	-	0	-	-	0	-
Grade, %	-	0	-	-	0	-	-	0	-	-	0	-
Peak Hour Factor	93	93	93	93	93	93	93	93	93	93	93	93
Heavy Vehicles, %	2	2	2	2	2	2	2	2	2	2	2	2
Mvmt Flow	9	2	34	42	2	2	40	191	51	3	122	12

Major/Minor	Minor2		Minor1		Major1			Major2				
Conflicting Flow All	406	455	127	425	436	217	133	0	0	242	0	0
Stage 1	134	134	-	296	296	-	-	-	-	-	-	-
Stage 2	272	322	-	129	140	-	-	-	-	-	-	-
Critical Hdwy	7.12	6.52	6.22	7.12	6.52	6.22	4.12	-	-	4.12	-	-
Critical Hdwy Stg 1	6.12	5.52	-	6.12	5.52	-	-	-	-	-	-	-
Critical Hdwy Stg 2	6.12	5.52	-	6.12	5.52	-	-	-	-	-	-	-
Follow-up Hdwy	3.518	4.018	3.318	3.518	4.018	3.318	2.218	-	-	2.218	-	-
Pot Cap-1 Maneuver	555	501	923	539	514	823	1451	-	-	1325	-	-
Stage 1	869	786	-	712	668	-	-	-	-	-	-	-
Stage 2	734	651	-	875	781	-	-	-	-	-	-	-
Platoon blocked, %								-	-	-	-	-
Mov Cap-1 Maneuver	535	486	923	501	498	823	1451	-	-	1325	-	-
Mov Cap-2 Maneuver	535	486	-	501	498	-	-	-	-	-	-	-
Stage 1	867	784	-	693	650	-	-	-	-	-	-	-
Stage 2	710	633	-	838	779	-	-	-	-	-	-	-

Approach	EB		WB		NB		SB	
HCM Control Delay, s/v	9.89		12.75		1.07		0.18	
HCM LOS	A		B					

Minor Lane/Major Mvmt	NBL	NBT	NBR	EBLn1	WBLn1	SBL	SBT	SBR
Capacity (veh/h)	1451	-	-	781	511	42	-	-
HCM Lane V/C Ratio	0.027	-	-	0.058	0.091	0.002	-	-
HCM Control Delay (s/veh)	7.6	-	-	9.9	12.8	7.7	0	-
HCM Lane LOS	A	-	-	A	B	A	A	-
HCM 95th %tile Q(veh)	0.1	-	-	0.2	0.3	0	-	-

Intersection						
Int Delay, s/veh	0.4					
Movement	EBT	EBR	WBL	WBT	NBL	NBR
Lane Configurations	T			T	T	
Traffic Vol, veh/h	122	5	5	183	4	5
Future Vol, veh/h	122	5	5	183	4	5
Conflicting Peds, #/hr	0	0	0	0	0	0
Sign Control	Free	Free	Free	Free	Stop	Stop
RT Channelized	-	None	-	None	-	None
Storage Length	-	-	-	-	0	-
Veh in Median Storage, #	0	-	-	0	0	-
Grade, %	0	-	-	0	0	-
Peak Hour Factor	93	93	93	93	93	93
Heavy Vehicles, %	2	2	2	2	2	2
Mvmt Flow	131	5	5	197	4	5

Major/Minor	Major1	Major2	Minor1	Minor2	Minor3
Conflicting Flow All	0	0	137	0	341
Stage 1	-	-	-	-	134
Stage 2	-	-	-	-	208
Critical Hdwy	-	-	4.12	-	6.42
Critical Hdwy Stg 1	-	-	-	-	5.42
Critical Hdwy Stg 2	-	-	-	-	5.42
Follow-up Hdwy	-	-	2.218	-	3.518
Pot Cap-1 Maneuver	-	-	1447	-	655
Stage 1	-	-	-	-	892
Stage 2	-	-	-	-	827
Platoon blocked, %	-	-	-	-	-
Mov Cap-1 Maneuver	-	-	1447	-	652
Mov Cap-2 Maneuver	-	-	-	-	652
Stage 1	-	-	-	-	892
Stage 2	-	-	-	-	824

Approach	EB	WB	NB
HCM Control Delay, s/v	0	0.2	9.7
HCM LOS			A

Minor Lane/Major Mvmt	NBLn1	EBT	EBR	WBL	WBT
Capacity (veh/h)	776	-	-	48	-
HCM Lane V/C Ratio	0.012	-	-	0.004	-
HCM Control Delay (s/veh)	9.7	-	-	7.5	0
HCM Lane LOS	A	-	-	A	A
HCM 95th %tile Q(veh)	0	-	-	0	-

Intersection						
Int Delay, s/veh	0.4					
Movement	EBT	EBR	WBL	WBT	NBL	NBR
Lane Configurations	1			4	4	
Traffic Vol, veh/h	123	5	5	182	4	4
Future Vol, veh/h	123	5	5	182	4	4
Conflicting Peds, #/hr	0	0	0	0	0	0
Sign Control	Free	Free	Free	Free	Stop	Stop
RT Channelized	-	None	-	None	-	None
Storage Length	-	-	-	-	0	-
Veh in Median Storage, #	0	-	-	0	0	-
Grade, %	0	-	-	0	0	-
Peak Hour Factor	93	93	93	93	93	93
Heavy Vehicles, %	2	2	2	2	2	2
Mvmt Flow	132	5	5	196	4	4

Major/Minor	Major1	Major2	Minor1		
Conflicting Flow All	0	0	138	0	341
Stage 1	-	-	-	-	135
Stage 2	-	-	-	-	206
Critical Hdwy	-	-	4.12	-	6.42
Critical Hdwy Stg 1	-	-	-	-	5.42
Critical Hdwy Stg 2	-	-	-	-	5.42
Follow-up Hdwy	-	-	2.218	-	3.518
Pot Cap-1 Maneuver	-	-	1446	-	655
Stage 1	-	-	-	-	891
Stage 2	-	-	-	-	828
Platoon blocked, %	-	-	-	-	-
Mov Cap-1 Maneuver	-	-	1446	-	652
Mov Cap-2 Maneuver	-	-	-	-	652
Stage 1	-	-	-	-	891
Stage 2	-	-	-	-	825

Approach	EB	WB	NB
HCM Control Delay, s/v	0	0.2	9.78
HCM LOS			A

Minor Lane/Major Mvmt	NBLn1	EBT	EBR	WBL	WBT
Capacity (veh/h)	761	-	-	48	-
HCM Lane V/C Ratio	0.011	-	-	0.004	-
HCM Control Delay (s/veh)	9.8	-	-	7.5	0
HCM Lane LOS	A	-	-	A	A
HCM 95th %tile Q(veh)	0	-	-	0	-

Queues
1: Ward Road & Oldham Parkway

Existing + Phase 1 Development Traffic Volumes

PM Peak Hour



Lane Group	EBL	EBT	WBT	NBL	NBT	SBL	SBT	SBR
Lane Group Flow (vph)	136	70	217	30	575	142	569	186
v/c Ratio	0.54	0.16	0.48	0.15	0.55	0.45	0.32	0.21
Control Delay (s/veh)	32.1	12.8	17.8	33.2	21.8	31.5	12.6	3.4
Queue Delay	0.0	0.0	0.0	0.0	0.0	0.0	0.0	0.0
Total Delay (s/veh)	32.1	12.8	17.8	33.2	21.8	31.5	12.6	3.4
Queue Length 50th (ft)	45	9	40	10	92	48	50	0
Queue Length 95th (ft)	118	43	118	42	184	125	156	38
Internal Link Dist (ft)		116	246		459		353	
Turn Bay Length (ft)				110		105		
Base Capacity (vph)	635	1032	987	479	2526	685	2860	1315
Starvation Cap Reductn	0	0	0	0	0	0	0	0
Spillback Cap Reductn	0	0	0	0	0	0	0	0
Storage Cap Reductn	0	0	0	0	0	0	0	0
Reduced v/c Ratio	0.21	0.07	0.22	0.06	0.23	0.21	0.20	0.14
Intersection Summary								

HCM 7th Signalized Intersection Summary Existing + Phase 1 Development Traffic Volumes
 1: Ward Road & Oldham Parkway PM Peak Hour



Movement	EBL	EBT	EBR	WBL	WBT	WBR	NBL	NBT	NBR	SBL	SBT	SBR
Lane Configurations												
Traffic Volume (veh/h)	133	29	39	31	38	143	29	529	34	139	558	182
Future Volume (veh/h)	133	29	39	31	38	143	29	529	34	139	558	182
Initial Q (Qb), veh	0	0	0	0	0	0	0	0	0	0	0	0
Lane Width Adj.	1.00	1.00	1.00	1.00	1.00	1.00	1.00	1.00	1.00	1.00	1.00	1.00
Ped-Bike Adj(A_pbT)	1.00		1.00	1.00		1.00	1.00		1.00	1.00		1.00
Parking Bus, Adj	1.00	1.00	1.00	1.00	1.00	1.00	1.00	1.00	1.00	1.00	1.00	1.00
Work Zone On Approach		No			No			No			No	
Adj Sat Flow, veh/h/ln	1870	1870	1870	1870	1870	1870	1870	1870	1870	1870	1870	1870
Adj Flow Rate, veh/h	136	30	40	32	39	146	30	540	35	142	569	186
Peak Hour Factor	0.98	0.98	0.98	0.98	0.98	0.98	0.98	0.98	0.98	0.98	0.98	0.98
Percent Heavy Veh, %	2	2	2	2	2	2	2	2	2	2	2	2
Cap, veh/h	376	139	186	113	74	209	61	1153	75	190	1467	654
Arrive On Green	0.19	0.19	0.19	0.19	0.19	0.19	0.03	0.34	0.34	0.11	0.41	0.41
Sat Flow, veh/h	1199	727	969	143	386	1088	1781	3389	219	1781	3554	1585
Grp Volume(v), veh/h	136	0	70	217	0	0	30	283	292	142	569	186
Grp Sat Flow(s),veh/h/ln	1199	0	1696	1617	0	0	1781	1777	1831	1781	1777	1585
Q Serve(g_s), s	0.0	0.0	1.7	2.4	0.0	0.0	0.8	6.0	6.1	3.7	5.4	3.8
Cycle Q Clear(g_c), s	5.1	0.0	1.7	6.0	0.0	0.0	0.8	6.0	6.1	3.7	5.4	3.8
Prop In Lane	1.00		0.57	0.15		0.67	1.00		0.12	1.00		1.00
Lane Grp Cap(c), veh/h	376	0	325	395	0	0	61	605	623	190	1467	654
V/C Ratio(X)	0.36	0.00	0.22	0.55	0.00	0.00	0.49	0.47	0.47	0.75	0.39	0.28
Avail Cap(c_a), veh/h	1035	0	1257	1265	0	0	599	1588	1636	857	3689	1646
HCM Platoon Ratio	1.00	1.00	1.00	1.00	1.00	1.00	1.00	1.00	1.00	1.00	1.00	1.00
Upstream Filter(I)	1.00	0.00	1.00	1.00	0.00	0.00	1.00	1.00	1.00	1.00	1.00	1.00
Uniform Delay (d), s/veh	17.9	0.0	16.5	18.2	0.0	0.0	23.0	12.5	12.5	21.0	9.9	9.5
Incr Delay (d2), s/veh	0.6	0.0	0.3	1.2	0.0	0.0	6.0	0.8	0.8	5.8	0.2	0.3
Initial Q Delay(d3), s/veh	0.0	0.0	0.0	0.0	0.0	0.0	0.0	0.0	0.0	0.0	0.0	0.0
%ile BackOfQ(95%),veh/ln	2.4	0.0	1.1	3.7	0.0	0.0	0.7	3.7	3.9	3.0	3.0	1.9
Unsig. Movement Delay, s/veh												
LnGrp Delay(d), s/veh	18.5	0.0	16.8	19.4	0.0	0.0	29.0	13.3	13.3	26.8	10.2	9.8
LnGrp LOS	B		B	B			C	B	B	C	B	A
Approach Vol, veh/h	206						217		605		897	
Approach Delay, s/veh	17.9						19.4		14.1		12.7	
Approach LOS	B						B		B		B	
Timer - Assigned Phs	1	2	4		5	6	8					
Phs Duration (G+Y+Rc), s	7.4	25.7	15.4		10.9	22.2	15.4					
Change Period (Y+Rc), s	5.7	5.7	6.1		5.7	5.7	6.1					
Max Green Setting (Gmax), s	16.3	50.3	35.9		23.3	43.3	35.9					
Max Q Clear Time (g_c+I1), s	2.8	7.4	8.0		5.7	8.1	7.1					
Green Ext Time (p_c), s	0.0	7.4	1.3		0.3	5.4	0.9					

Intersection Summary												
HCM 7th Control Delay, s/veh			14.5									
HCM 7th LOS			B									

Notes
 User approved pedestrian interval to be less than phase max green.

HCM 7th TWSC
2: Jefferson Street & Oldham Parkway

Existing + Phase 1 Development Traffic Volumes
PM Peak Hour

Intersection												
Int Delay, s/veh	1											
Movement	EBL	EBT	EBR	WBL	WBT	WBR	NBL	NBT	NBR	SBL	SBT	SBR
Lane Configurations	↗	↗↘		↗	↗↘				↗			↗
Traffic Vol, veh/h	2	542	20	64	302	278	0	0	68	0	0	2
Future Vol, veh/h	2	542	20	64	302	278	0	0	68	0	0	2
Conflicting Peds, #/hr	0	0	0	0	0	0	0	0	0	0	0	0
Sign Control	Free	Free	Free	Free	Free	Free	Stop	Stop	Stop	Stop	Stop	Stop
RT Channelized	-	-	None	-	-	None	-	-	None	-	-	None
Storage Length	150	-	-	200	-	-	-	-	0	-	-	0
Veh in Median Storage, #	-	0	-	-	0	-	-	0	-	-	0	-
Grade, %	-	0	-	-	0	-	-	0	-	-	0	-
Peak Hour Factor	98	98	98	98	98	98	98	98	98	98	98	98
Heavy Vehicles, %	2	2	2	2	2	2	2	2	2	2	2	2
Mvmt Flow	2	553	20	65	308	284	0	0	69	0	0	2

Major/Minor	Major1			Major2			Minor1			Minor2		
Conflicting Flow All	592	0	0	573	0	0	-	-	287	-	-	296
Stage 1	-	-	-	-	-	-	-	-	-	-	-	-
Stage 2	-	-	-	-	-	-	-	-	-	-	-	-
Critical Hdwy	4.14	-	-	4.14	-	-	-	-	6.94	-	-	6.94
Critical Hdwy Stg 1	-	-	-	-	-	-	-	-	-	-	-	-
Critical Hdwy Stg 2	-	-	-	-	-	-	-	-	-	-	-	-
Follow-up Hdwy	2.22	-	-	2.22	-	-	-	-	3.32	-	-	3.32
Pot Cap-1 Maneuver	980	-	-	996	-	-	0	0	710	0	0	700
Stage 1	-	-	-	-	-	-	0	0	-	0	0	-
Stage 2	-	-	-	-	-	-	0	0	-	0	0	-
Platoon blocked, %	-	-	-	-	-	-	-	-	-	-	-	-
Mov Cap-1 Maneuver	980	-	-	996	-	-	-	-	710	-	-	700
Mov Cap-2 Maneuver	-	-	-	-	-	-	-	-	-	-	-	-
Stage 1	-	-	-	-	-	-	-	-	-	-	-	-
Stage 2	-	-	-	-	-	-	-	-	-	-	-	-

Approach	EB			WB			NB			SB		
HCM Control Delay, s/v	0.03			0.88			10.62			10.16		
HCM LOS							B			B		

Minor Lane/Major Mvmt	NBLn1	EBL	EBT	EBR	WBL	WBT	WBR	SBLn1
Capacity (veh/h)	710	980	-	-	996	-	-	700
HCM Lane V/C Ratio	0.098	0.002	-	-	0.066	-	-	0.003
HCM Control Delay (s/veh)	10.6	8.7	-	-	8.9	-	-	10.2
HCM Lane LOS	B	A	-	-	A	-	-	B
HCM 95th %tile Q(veh)	0.3	0	-	-	0.2	-	-	0

Queues
3: M-291 & Oldham Parkway

Existing + Phase 1 Development Traffic Volumes
PM Peak Hour

































Lane Group	EBL	EBR	NBL	NBT	SBT	SBR
Lane Group Flow (vph)	372	243	245	1465	1809	378
v/c Ratio	0.76	0.47	0.65	0.38	0.62	0.37
Control Delay (s/veh)	60.0	3.6	46.5	1.0	18.6	6.0
Queue Delay	0.0	0.0	0.0	0.0	0.0	0.0
Total Delay (s/veh)	60.0	3.6	46.5	1.0	18.6	6.0
Queue Length 50th (ft)	143	0	96	8	335	47
Queue Length 95th (ft)	195	6	m130	m6	398	109
Internal Link Dist (ft)				613	887	
Turn Bay Length (ft)	345		250			180
Base Capacity (vph)	537	549	423	3778	2912	1011
Starvation Cap Reductn	0	0	0	0	0	0
Spillback Cap Reductn	0	0	0	0	0	0
Storage Cap Reductn	0	0	0	0	0	0
Reduced v/c Ratio	0.69	0.44	0.58	0.39	0.62	0.37

Intersection Summary

m Volume for 95th percentile queue is metered by upstream signal.

HCM 7th Signalized Intersection Summary Existing + Phase 1 Development Traffic Volumes
 3: M-291 & Oldham Parkway PM Peak Hour

												
Movement	EBL	EBT	EBR	WBL	WBT	WBR	NBL	NBT	NBR	SBL	SBT	SBR
Lane Configurations	 		 	 		 	 	  	 			
Traffic Volume (veh/h)	365	0	238	0	0	0	240	1436	0	0	1773	370
Future Volume (veh/h)	365	0	238	0	0	0	240	1436	0	0	1773	370
Initial Q (Qb), veh	0	0	0	0	0	0	0	0	0	0	0	0
Lane Width Adj.	1.00	1.00	1.00	1.00	1.00	1.00	1.00	1.00	1.00	1.00	1.00	1.00
Ped-Bike Adj(A_pbT)	1.00		1.00	1.00		1.00	1.00		1.00	1.00		1.00
Parking Bus, Adj	1.00	1.00	1.00	1.00	1.00	1.00	1.00	1.00	1.00	1.00	1.00	1.00
Work Zone On Approach		No			No			No			No	
Adj Sat Flow, veh/h/ln	1870	1870	1870	1870	1870	1870	1870	1870	1870	1870	1870	1870
Adj Flow Rate, veh/h	372	0	0	0	0	0	245	1465	0	0	1809	0
Peak Hour Factor	0.98	0.98	0.98	0.98	0.98	0.98	0.98	0.98	0.98	0.98	0.98	0.98
Percent Heavy Veh, %	2	2	2	2	2	2	2	2	2	2	2	2
Cap, veh/h	438	240		3	2	1	980	3847		3	2117	
Arrive On Green	0.13	0.00	0.00	0.00	0.00	0.00	0.57	1.00	0.00	0.00	0.41	0.00
Sat Flow, veh/h	3456	1870	1585	3456	1870	1585	3456	5106	1585	3456	5106	1585
Grp Volume(v), veh/h	372	0	0	0	0	0	245	1465	0	0	1809	0
Grp Sat Flow(s),veh/h/ln	1728	1870	1585	1728	1870	1585	1728	1702	1585	1728	1702	1585
Q Serve(g_s), s	12.6	0.0	0.0	0.0	0.0	0.0	4.3	0.0	0.0	0.0	38.5	0.0
Cycle Q Clear(g_c), s	12.6	0.0	0.0	0.0	0.0	0.0	4.3	0.0	0.0	0.0	38.5	0.0
Prop In Lane	1.00		1.00	1.00		1.00	1.00		1.00	1.00		1.00
Lane Grp Cap(c), veh/h	438	240		3	2	1	980	3847		3	2117	
V/C Ratio(X)	0.85	0.00		0.00	0.00	0.00	0.25	0.38		0.00	0.85	
Avail Cap(c_a), veh/h	541	320		144	109	92	980	3847		144	2196	
HCM Platoon Ratio	1.00	1.00	1.00	1.00	1.00	1.00	2.00	2.00	2.00	1.00	1.00	1.00
Upstream Filter(I)	1.00	0.00	0.00	0.00	0.00	0.00	1.00	1.00	0.00	0.00	1.00	0.00
Uniform Delay (d), s/veh	51.3	0.0	0.0	0.0	0.0	0.0	19.5	0.0	0.0	0.0	31.8	0.0
Incr Delay (d2), s/veh	10.3	0.0	0.0	0.0	0.0	0.0	0.1	0.3	0.0	0.0	4.7	0.0
Initial Q Delay(d3), s/veh	0.0	0.0	0.0	0.0	0.0	0.0	0.0	0.0	0.0	0.0	0.0	0.0
%ile BackOfQ(95%),veh/ln	10.2	0.0	0.0	0.0	0.0	0.0	2.9	0.2	0.0	0.0	22.3	0.0
Unsig. Movement Delay, s/veh												
LnGrp Delay(d), s/veh	61.6	0.0	0.0	0.0	0.0	0.0	19.7	0.3	0.0	0.0	36.5	0.0
LnGrp LOS	E						B	A			D	
Approach Vol, veh/h		372			0			1710			1809	
Approach Delay, s/veh		61.6			0.0			3.1			36.5	
Approach LOS		E						A			D	
Timer - Assigned Phs	1	2	3	4	5	6	7	8				
Phs Duration (G+Y+Rc), s	0.0	97.6	0.0	22.4	41.2	56.4	22.4	0.0				
Change Period (Y+Rc), s	6.7	* 7.2	7.3	7.0	7.2	6.6	7.2	* 7				
Max Green Setting (Gmax), s	5.0	* 62	5.0	20.5	14.8	51.6	18.8	* 7				
Max Q Clear Time (g_c+I1), s	0.0	2.0	0.0	0.0	6.3	40.5	14.6	0.0				
Green Ext Time (p_c), s	0.0	22.3	0.0	0.0	0.5	9.2	0.6	0.0				
Intersection Summary												
HCM 7th Control Delay, s/veh			24.2									
HCM 7th LOS			C									
Notes												
User approved pedestrian interval to be less than phase max green.												
* HCM 7th computational engine requires equal clearance times for the phases crossing the barrier.												

Unsignalized Delay for [NBR, EBR, SBR] is excluded from calculations of the approach delay and intersection delay.

Queues

Existing + Phase 1 Development Traffic Volumes

4: Jefferson Street & Persels Road

PM Peak Hour























Lane Group	EBL	EBT	WBL	WBT	NBL	NBT	SBL	SBT
Lane Group Flow (vph)	6	273	172	302	18	222	14	71
v/c Ratio	0.00	0.13	0.19	0.23	0.07	0.59	0.07	0.28
Control Delay (s/veh)	7.3	12.6	4.6	5.6	36.5	17.9	36.2	38.4
Queue Delay	0.0	0.0	0.0	0.0	0.0	0.0	0.0	0.0
Total Delay (s/veh)	7.3	12.6	4.6	5.6	36.5	17.9	36.2	38.4
Queue Length 50th (ft)	1	35	3	4	13	27	10	38
Queue Length 95th (ft)	7	94	m82	m183	29	102	24	80
Internal Link Dist (ft)		1272		101		1173		315
Turn Bay Length (ft)	110		175		110		150	
Base Capacity (vph)	752	2091	889	1312	255	618	186	546
Starvation Cap Reductn	0	0	0	0	0	0	0	0
Spillback Cap Reductn	0	0	0	0	0	0	0	0
Storage Cap Reductn	0	0	0	0	0	0	0	0
Reduced v/c Ratio	0.01	0.13	0.19	0.23	0.07	0.36	0.08	0.13

Intersection Summary

m Volume for 95th percentile queue is metered by upstream signal.

HCM 7th Signalized Intersection Summary Existing + Phase 1 Development Traffic Volumes
 4: Jefferson Street & Persels Road PM Peak Hour

												
Movement	EBL	EBT	EBR	WBL	WBT	WBR	NBL	NBT	NBR	SBL	SBT	SBR
Lane Configurations												
Traffic Volume (veh/h)	6	252	16	169	280	16	18	37	180	14	49	21
Future Volume (veh/h)	6	252	16	169	280	16	18	37	180	14	49	21
Initial Q (Qb), veh	0	0	0	0	0	0	0	0	0	0	0	0
Lane Width Adj.	1.00	1.00	1.00	1.00	1.00	1.00	1.00	1.00	1.00	1.00	1.00	1.00
Ped-Bike Adj(A_pbT)	1.00		1.00	1.00		1.00	1.00		1.00	1.00		1.00
Parking Bus, Adj	1.00	1.00	1.00	1.00	1.00	1.00	1.00	1.00	1.00	1.00	1.00	1.00
Work Zone On Approach		No			No			No			No	
Adj Sat Flow, veh/h/ln	1870	1870	1870	1870	1870	1870	1870	1870	1870	1870	1870	1870
Adj Flow Rate, veh/h	6	257	16	172	286	16	18	38	184	14	50	21
Peak Hour Factor	0.98	0.98	0.98	0.98	0.98	0.98	0.98	0.98	0.98	0.98	0.98	0.98
Percent Heavy Veh, %	2	2	2	2	2	2	2	2	2	2	2	2
Cap, veh/h	849	425	26	1010	338	19	293	46	224	155	200	84
Arrive On Green	0.44	0.13	0.13	1.00	0.39	0.39	0.04	0.17	0.17	0.03	0.16	0.16
Sat Flow, veh/h	1781	3399	210	1781	1755	98	1781	279	1349	1781	1251	525
Grp Volume(v), veh/h	6	134	139	172	0	302	18	0	222	14	0	71
Grp Sat Flow(s),veh/h/ln	1781	1777	1832	1781	0	1853	1781	0	1628	1781	0	1776
Q Serve(g_s), s	0.0	8.5	8.6	0.0	0.0	17.8	1.0	0.0	15.8	0.8	0.0	4.2
Cycle Q Clear(g_c), s	0.0	8.5	8.6	0.0	0.0	17.8	1.0	0.0	15.8	0.8	0.0	4.2
Prop In Lane	1.00		0.11	1.00		0.05	1.00		0.83	1.00		0.30
Lane Grp Cap(c), veh/h	849	222	229	1010	0	357	293	0	271	155	0	284
V/C Ratio(X)	0.01	0.60	0.61	0.17	0.00	0.85	0.06	0.00	0.82	0.09	0.00	0.25
Avail Cap(c_a), veh/h	849	622	641	1010	0	679	374	0	488	248	0	533
HCM Platoon Ratio	1.00	1.00	1.00	2.00	2.00	2.00	1.00	1.00	1.00	1.00	1.00	1.00
Upstream Filter(I)	1.00	1.00	1.00	1.00	0.00	1.00	1.00	0.00	1.00	1.00	0.00	1.00
Uniform Delay (d), s/veh	18.6	49.7	49.7	0.0	0.0	35.2	39.1	0.0	48.3	40.6	0.0	44.1
Incr Delay (d2), s/veh	0.0	11.5	11.5	0.1	0.0	21.1	0.1	0.0	12.2	0.4	0.0	1.0
Initial Q Delay(d3), s/veh	0.0	0.0	0.0	0.0	0.0	0.0	0.0	0.0	0.0	0.0	0.0	0.0
%ile BackOfQ(95%),veh/ln	0.2	7.9	8.2	0.1	0.0	13.3	0.8	0.0	11.7	0.6	0.0	3.5
Unsig. Movement Delay, s/veh												
LnGrp Delay(d), s/veh	18.6	61.2	61.2	0.1	0.0	56.4	39.3	0.0	60.5	40.9	0.0	45.1
LnGrp LOS	B	E	E	A		E	D		E	D		D
Approach Vol, veh/h		279			474			240				85
Approach Delay, s/veh		60.3			35.9			58.9				44.4
Approach LOS		E			D			E				D
Timer - Assigned Phs	1	2	3	4	5	6	7	8				
Phs Duration (G+Y+Rc), s	66.3	20.0	8.7	24.9	58.2	28.1	9.5	24.2				
Change Period (Y+Rc), s	5.0	5.0	5.0	5.0	5.0	5.0	5.0	5.0				
Max Green Setting (Gmax), s	12.0	42.0	10.0	36.0	10.0	44.0	10.0	36.0				
Max Q Clear Time (g_c+I1), s	2.0	10.6	2.8	17.8	2.0	19.8	3.0	6.2				
Green Ext Time (p_c), s	0.5	3.1	0.0	2.1	0.0	3.3	0.0	0.6				
Intersection Summary												
HCM 7th Control Delay, s/veh				48.0								
HCM 7th LOS				D								

Queues
5: M-291 & Persels Road/Bailey Road

Existing + Phase 1 Development Traffic Volumes
PM Peak Hour



Lane Group	EBL	EBT	WBL	WBT	WBR	NBL	NBT	NBR	SBL	SBT	SBR
Lane Group Flow (vph)	378	170	335	142	98	45	1329	273	50	1734	362
v/c Ratio	1.01	0.98	0.90	0.84	0.29	0.43	0.49	0.28	0.40	0.89	0.36
Control Delay (s/veh)	97.9	110.6	81.7	92.3	2.2	68.1	19.2	2.6	45.7	19.2	1.5
Queue Delay	0.0	0.0	0.0	0.0	0.0	0.0	0.0	0.0	0.0	0.0	0.0
Total Delay (s/veh)	97.9	110.6	81.7	92.3	2.2	68.1	19.2	2.6	45.7	19.2	1.5
Queue Length 50th (ft)	~161	129	134	110	0	34	242	0	38	163	8
Queue Length 95th (ft)	#264	#249	#220	#225	0	75	284	42	m65	#824	21
Internal Link Dist (ft)		341		1421			2289			705	
Turn Bay Length (ft)	200		280		290	310		350	330		
Base Capacity (vph)	373	173	369	169	331	103	2707	970	127	1932	989
Starvation Cap Reductn	0	0	0	0	0	0	0	0	0	0	0
Spillback Cap Reductn	0	0	0	0	0	0	0	0	0	0	0
Storage Cap Reductn	0	0	0	0	0	0	0	0	0	0	0
Reduced v/c Ratio	1.01	0.98	0.91	0.84	0.30	0.44	0.49	0.28	0.39	0.90	0.37























Intersection Summary

- ~ Volume exceeds capacity, queue is theoretically infinite.
Queue shown is maximum after two cycles.
- # 95th percentile volume exceeds capacity, queue may be longer.
Queue shown is maximum after two cycles.
- m Volume for 95th percentile queue is metered by upstream signal.

HCM 7th Signalized Intersection Summary
5: M-291 & Persels Road/Bailey Road

Existing + Phase 1 Development Traffic Volumes

PM Peak Hour

												
Movement	EBL	EBT	EBR	WBL	WBT	WBR	NBL	NBT	NBR	SBL	SBT	SBR
Lane Configurations												
Traffic Volume (veh/h)	370	131	35	328	139	96	44	1302	268	49	1699	355
Future Volume (veh/h)	370	131	35	328	139	96	44	1302	268	49	1699	355
Initial Q (Qb), veh	0	0	0	0	0	0	0	0	0	0	0	0
Lane Width Adj.	1.00	1.00	1.00	1.00	1.00	1.00	1.00	1.00	1.00	1.00	1.00	1.00
Ped-Bike Adj(A_pbT)	1.00		1.00	1.00		1.00	1.00		1.00	1.00		1.00
Parking Bus, Adj	1.00	1.00	1.00	1.00	1.00	1.00	1.00	1.00	1.00	1.00	1.00	1.00
Work Zone On Approach		No			No			No			No	
Adj Sat Flow, veh/h/ln	1870	1870	1856	1870	1870	1870	1870	1870	1870	1870	1870	1870
Adj Flow Rate, veh/h	378	134	36	335	142	98	45	1329	0	50	1734	0
Peak Hour Factor	0.98	0.98	0.98	0.98	0.98	0.98	0.98	0.98	0.98	0.98	0.98	0.98
Percent Heavy Veh, %	2	2	3	2	2	2	2	2	2	2	2	2
Cap, veh/h	374	130	35	374	170	144	81	2142		283	1906	
Arrive On Green	0.04	0.03	0.03	0.11	0.09	0.09	0.05	0.42	0.00	0.21	0.71	0.00
Sat Flow, veh/h	3456	1420	382	3456	1870	1585	1781	5106	1585	1781	3554	1585
Grp Volume(v), veh/h	378	0	170	335	142	98	45	1329	0	50	1734	0
Grp Sat Flow(s),veh/h/ln	1728	0	1802	1728	1870	1585	1781	1702	1585	1781	1777	1585
Q Serve(g_s), s	13.0	0.0	11.0	11.5	9.0	7.2	3.0	24.5	0.0	2.8	47.8	0.0
Cycle Q Clear(g_c), s	13.0	0.0	11.0	11.5	9.0	7.2	3.0	24.5	0.0	2.8	47.8	0.0
Prop In Lane	1.00		0.21	1.00		1.00	1.00		1.00	1.00		1.00
Lane Grp Cap(c), veh/h	374	0	165	374	170	144	81	2142		283	1906	
V/C Ratio(X)	1.01	0.00	1.03	0.89	0.84	0.68	0.56	0.62		0.18	0.91	
Avail Cap(c_a), veh/h	374	0	165	374	170	144	104	2596		283	1906	
HCM Platoon Ratio	0.33	0.33	0.33	1.00	1.00	1.00	1.00	1.00	1.00	1.33	1.33	1.33
Upstream Filter(I)	1.00	0.00	1.00	1.00	1.00	1.00	1.00	1.00	0.00	1.00	1.00	0.00
Uniform Delay (d), s/veh	57.9	0.0	58.2	52.8	53.7	52.9	56.1	27.3	0.0	40.9	14.8	0.0
Incr Delay (d2), s/veh	49.0	0.0	78.0	23.0	28.8	12.3	5.9	1.4	0.0	0.3	8.0	0.0
Initial Q Delay(d3), s/veh	0.0	0.0	0.0	0.0	0.0	0.0	0.0	0.0	0.0	0.0	0.0	0.0
%ile BackOfQ(95%),veh/ln	13.4	0.0	13.9	10.2	9.4	6.0	2.6	14.8	0.0	2.2	20.2	0.0
Unsig. Movement Delay, s/veh												
LnGrp Delay(d), s/veh	106.8	0.0	136.1	75.8	82.5	65.1	62.0	28.7	0.0	41.2	22.8	0.0
LnGrp LOS	F		F	E	F	E	E	C		D	C	
Approach Vol, veh/h		548			575			1374			1784	
Approach Delay, s/veh		115.9			75.6			29.8			23.3	
Approach LOS		F			E			C			C	
Timer - Assigned Phs	1	2	3	4	5	6	7	8				
Phs Duration (G+Y+Rc), s	25.1	56.8	20.1	18.0	11.5	70.4	20.1	18.0				
Change Period (Y+Rc), s	6.0	6.5	7.1	7.0	6.1	6.0	7.1	* 7.1				
Max Green Setting (Gmax), s	8.5	61.0	12.9	11.0	7.0	62.9	13.0	* 11				
Max Q Clear Time (g_c+I1), s	4.8	26.5	13.5	13.0	5.0	49.8	15.0	11.0				
Green Ext Time (p_c), s	0.0	23.8	0.0	0.0	0.0	12.3	0.0	0.0				

Intersection Summary

HCM 7th Control Delay, s/veh	44.3
HCM 7th LOS	D

Notes

User approved pedestrian interval to be less than phase max green.
* HCM 7th computational engine requires equal clearance times for the phases crossing the barrier.

Unsignalized Delay for [NBR, SBR] is excluded from calculations of the approach delay and intersection delay.

Intersection						
Int Delay, s/veh	0.2					
Movement	EBL	EBR	NBL	NBT	SBT	SBR
Lane Configurations		↗		↕	↕	
Traffic Vol, veh/h	0	18	0	304	546	0
Future Vol, veh/h	0	18	0	304	546	0
Conflicting Peds, #/hr	0	0	0	0	0	0
Sign Control	Stop	Stop	Free	Free	Free	Free
RT Channelized	-	None	-	None	-	None
Storage Length	-	0	-	-	-	-
Veh in Median Storage, #	0	-	-	0	0	-
Grade, %	0	-	-	0	0	-
Peak Hour Factor	98	98	98	98	98	98
Heavy Vehicles, %	2	2	2	2	2	2
Mvmt Flow	0	18	0	310	557	0

Major/Minor	Minor2	Major1	Major2		
Conflicting Flow All	-	557	-	0	-
Stage 1	-	-	-	-	-
Stage 2	-	-	-	-	-
Critical Hdwy	-	6.23	-	-	-
Critical Hdwy Stg 1	-	-	-	-	-
Critical Hdwy Stg 2	-	-	-	-	-
Follow-up Hdwy	-	3.319	-	-	-
Pot Cap-1 Maneuver	0	529	0	-	-
Stage 1	0	-	0	-	-
Stage 2	0	-	0	-	-
Platoon blocked, %				-	-
Mov Cap-1 Maneuver	-	529	-	-	-
Mov Cap-2 Maneuver	-	-	-	-	-
Stage 1	-	-	-	-	-
Stage 2	-	-	-	-	-

Approach	EB	NB	SB
HCM Control Delay, s/v12.05		0	0
HCM LOS	B		

Minor Lane/Major Mvmt	NBT EBLn1	SBT
Capacity (veh/h)	- 529	-
HCM Lane V/C Ratio	- 0.035	-
HCM Control Delay (s/veh)	- 12.1	-
HCM Lane LOS	- B	-
HCM 95th %tile Q(veh)	- 0.1	-

HCM 7th TWSC
7: Oldham Parkway & Access 2

Existing + Full Development Traffic Volumes
PM Peak Hour

Intersection												
Int Delay, s/veh	22.3											
Movement	EBL	EBT	EBR	WBL	WBT	WBR	NBL	NBT	NBR	SBL	SBT	SBR
Lane Configurations	↖	↗		↖	↗		↖	↗	↖	↗	↖	↗
Traffic Vol, veh/h	14	20	72	290	20	3	97	180	27	4	199	16
Future Vol, veh/h	14	20	72	290	20	3	97	180	27	4	199	16
Conflicting Peds, #/hr	0	0	0	0	0	0	0	0	0	0	0	0
Sign Control	Stop	Stop	Stop	Stop	Stop	Stop	Free	Free	Free	Free	Free	Free
RT Channelized	-	-	None	-	-	None	-	-	None	-	-	None
Storage Length	0	-	-	0	-	-	150	-	0	100	-	-
Veh in Median Storage, #	-	0	-	-	0	-	-	0	-	-	0	-
Grade, %	-	0	-	-	0	-	-	0	-	-	0	-
Peak Hour Factor	98	98	98	98	98	98	98	98	98	98	98	98
Heavy Vehicles, %	2	2	2	2	2	2	2	2	2	2	2	2
Mvmt Flow	14	20	73	296	20	3	99	184	28	4	203	16

Major/Minor	Minor2		Minor1		Major1		Major2					
Conflicting Flow All	611	629	211	603	609	184	219	0	0	211	0	0
Stage 1	219	219	-	382	382	-	-	-	-	-	-	-
Stage 2	392	409	-	221	228	-	-	-	-	-	-	-
Critical Hdwy	7.12	6.52	6.22	7.12	6.52	6.22	4.12	-	-	4.12	-	-
Critical Hdwy Stg 1	6.12	5.52	-	6.12	5.52	-	-	-	-	-	-	-
Critical Hdwy Stg 2	6.12	5.52	-	6.12	5.52	-	-	-	-	-	-	-
Follow-up Hdwy	3.518	4.018	3.318	3.518	4.018	3.318	2.218	-	-	2.218	-	-
Pot Cap-1 Maneuver	406	399	829	411	410	859	1350	-	-	1359	-	-
Stage 1	783	722	-	641	613	-	-	-	-	-	-	-
Stage 2	633	596	-	781	716	-	-	-	-	-	-	-
Platoon blocked, %								-	-	-	-	-
Mov Cap-1 Maneuver	355	369	829	328	379	859	1350	-	-	1359	-	-
Mov Cap-2 Maneuver	355	369	-	328	379	-	-	-	-	-	-	-
Stage 1	781	719	-	594	568	-	-	-	-	-	-	-
Stage 2	563	552	-	690	714	-	-	-	-	-	-	-

Approach	EB	WB	NB	SB
HCM Control Delay, s/v11.99		60.46	2.51	0.14
HCM LOS	B	F		

Minor Lane/Major Mvmt	NBL	NBT	NBR	EBLn1	EBLn2	WBLn1	WBLn2	SBL	SBT	SBR
Capacity (veh/h)	1350	-	-	355	652	328	408	1359	-	-
HCM Lane V/C Ratio	0.073	-	-	0.04	0.144	0.902	0.057	0.003	-	-
HCM Control Delay (s/veh)	7.9	-	-	15.6	11.4	64.1	14.4	7.7	-	-
HCM Lane LOS	A	-	-	C	B	F	B	A	-	-
HCM 95th %tile Q(veh)	0.2	-	-	0.1	0.5	8.7	0.2	0	-	-

HCM 7th TWSC
8: Oldham Parkway & Access 3

Existing + Phase 1 Development Traffic Volumes
PM Peak Hour

Intersection												
Int Delay, s/veh	2.6											
Movement	EBL	EBT	EBR	WBL	WBT	WBR	NBL	NBT	NBR	SBL	SBT	SBR
Lane Configurations		↕			↕		↗	↖			↕	
Traffic Vol, veh/h	7	2	31	35	2	2	33	128	36	2	138	8
Future Vol, veh/h	7	2	31	35	2	2	33	128	36	2	138	8
Conflicting Peds, #/hr	0	0	0	0	0	0	0	0	0	0	0	0
Sign Control	Stop	Stop	Stop	Stop	Stop	Stop	Free	Free	Free	Free	Free	Free
RT Channelized	-	-	None	-	-	None	-	-	None	-	-	None
Storage Length	-	-	-	-	-	-	150	-	-	-	-	-
Veh in Median Storage, #	-	0	-	-	0	-	-	0	-	-	0	-
Grade, %	-	0	-	-	0	-	-	0	-	-	0	-
Peak Hour Factor	98	98	98	98	98	98	98	98	98	98	98	98
Heavy Vehicles, %	2	2	2	2	2	2	2	2	2	2	2	2
Mvmt Flow	7	2	32	36	2	2	34	131	37	2	141	8

Major/Minor	Minor2		Minor1		Major1		Major2					
Conflicting Flow All	348	384	145	362	369	149	149	0	0	167	0	0
Stage 1	149	149	-	216	216	-	-	-	-	-	-	-
Stage 2	199	235	-	146	153	-	-	-	-	-	-	-
Critical Hdwy	7.12	6.52	6.22	7.12	6.52	6.22	4.12	-	-	4.12	-	-
Critical Hdwy Stg 1	6.12	5.52	-	6.12	5.52	-	-	-	-	-	-	-
Critical Hdwy Stg 2	6.12	5.52	-	6.12	5.52	-	-	-	-	-	-	-
Follow-up Hdwy	3.518	4.018	3.318	3.518	4.018	3.318	2.218	-	-	2.218	-	-
Pot Cap-1 Maneuver	607	550	902	594	560	898	1432	-	-	1410	-	-
Stage 1	854	774	-	786	724	-	-	-	-	-	-	-
Stage 2	803	711	-	857	771	-	-	-	-	-	-	-
Platoon blocked, %								-	-	-	-	-
Mov Cap-1 Maneuver	588	536	902	556	546	898	1432	-	-	1410	-	-
Mov Cap-2 Maneuver	588	536	-	556	546	-	-	-	-	-	-	-
Stage 1	852	773	-	767	707	-	-	-	-	-	-	-
Stage 2	780	694	-	823	770	-	-	-	-	-	-	-

Approach	EB		WB		NB		SB	
HCM Control Delay, s/v	9.74		11.83		1.27		0.1	
HCM LOS	A		B					

Minor Lane/Major Mvmt	NBL	NBT	NBR	EBLn1WBLn1	SBL	SBT	SBR
Capacity (veh/h)	1432	-	-	800	567	24	-
HCM Lane V/C Ratio	0.024	-	-	0.051	0.07	0.001	-
HCM Control Delay (s/veh)	7.6	-	-	9.7	11.8	7.6	0
HCM Lane LOS	A	-	-	A	B	A	A
HCM 95th %tile Q(veh)	0.1	-	-	0.2	0.2	0	-

Intersection						
Int Delay, s/veh	0.4					
Movement	EBT	EBR	WBL	WBT	NBL	NBR
Lane Configurations	T			T	T	
Traffic Vol, veh/h	144	4	4	133	4	4
Future Vol, veh/h	144	4	4	133	4	4
Conflicting Peds, #/hr	0	0	0	0	0	0
Sign Control	Free	Free	Free	Free	Stop	Stop
RT Channelized	-	None	-	None	-	None
Storage Length	-	-	-	-	0	-
Veh in Median Storage, #	0	-	-	0	0	-
Grade, %	0	-	-	0	0	-
Peak Hour Factor	98	98	98	98	98	98
Heavy Vehicles, %	2	2	2	2	2	2
Mvmt Flow	147	4	4	136	4	4

Major/Minor	Major1	Major2	Minor1		
Conflicting Flow All	0	0	151	0	293
Stage 1	-	-	-	-	149
Stage 2	-	-	-	-	144
Critical Hdwy	-	-	4.12	-	6.42
Critical Hdwy Stg 1	-	-	-	-	5.42
Critical Hdwy Stg 2	-	-	-	-	5.42
Follow-up Hdwy	-	-	2.218	-	3.518
Pot Cap-1 Maneuver	-	-	1430	-	698
Stage 1	-	-	-	-	879
Stage 2	-	-	-	-	883
Platoon blocked, %	-	-	-	-	-
Mov Cap-1 Maneuver	-	-	1430	-	696
Mov Cap-2 Maneuver	-	-	-	-	696
Stage 1	-	-	-	-	879
Stage 2	-	-	-	-	881

Approach	EB	WB	NB
HCM Control Delay, s/v	0	0.22	9.64
HCM LOS			A

Minor Lane/Major Mvmt	NBLn1	EBT	EBR	WBL	WBT
Capacity (veh/h)	784	-	-	53	-
HCM Lane V/C Ratio	0.01	-	-	0.003	-
HCM Control Delay (s/veh)	9.6	-	-	7.5	0
HCM Lane LOS	A	-	-	A	A
HCM 95th %tile Q(veh)	0	-	-	0	-

Intersection						
Int Delay, s/veh	0.4					
Movement	EBT	EBR	WBL	WBT	NBL	NBR
Lane Configurations	T			T	T	
Traffic Vol, veh/h	144	4	4	133	4	4
Future Vol, veh/h	144	4	4	133	4	4
Conflicting Peds, #/hr	0	0	0	0	0	0
Sign Control	Free	Free	Free	Free	Stop	Stop
RT Channelized	-	None	-	None	-	None
Storage Length	-	-	-	-	0	-
Veh in Median Storage, #	0	-	-	0	0	-
Grade, %	0	-	-	0	0	-
Peak Hour Factor	98	98	98	98	98	98
Heavy Vehicles, %	2	2	2	2	2	2
Mvmt Flow	147	4	4	136	4	4

Major/Minor	Major1	Major2	Minor1	Minor2	Minor3
Conflicting Flow All	0	0	151	0	293
Stage 1	-	-	-	-	149
Stage 2	-	-	-	-	144
Critical Hdwy	-	-	4.12	-	6.42
Critical Hdwy Stg 1	-	-	-	-	5.42
Critical Hdwy Stg 2	-	-	-	-	5.42
Follow-up Hdwy	-	-	2.218	-	3.518
Pot Cap-1 Maneuver	-	-	1430	-	698
Stage 1	-	-	-	-	879
Stage 2	-	-	-	-	883
Platoon blocked, %	-	-	-	-	-
Mov Cap-1 Maneuver	-	-	1430	-	696
Mov Cap-2 Maneuver	-	-	-	-	696
Stage 1	-	-	-	-	879
Stage 2	-	-	-	-	881

Approach	EB	WB	NB
HCM Control Delay, s/v	0	0.22	9.64
HCM LOS			A

Minor Lane/Major Mvmt	NBLn1	EBT	EBR	WBL	WBT
Capacity (veh/h)	784	-	-	53	-
HCM Lane V/C Ratio	0.01	-	-	0.003	-
HCM Control Delay (s/veh)	9.6	-	-	7.5	0
HCM Lane LOS	A	-	-	A	A
HCM 95th %tile Q(veh)	0	-	-	0	-

Queues
1: Ward Road & Oldham Parkway

Existing + Phase 1 Development Traffic Volumes
SAT Peak Hour



Lane Group	EBL	EBT	WBT	NBL	NBT	SBL	SBT	SBR
Lane Group Flow (vph)	164	46	204	32	616	144	397	197
v/c Ratio	0.59	0.10	0.42	0.17	0.57	0.47	0.22	0.22
Control Delay (s/veh)	33.7	12.7	13.9	35.8	23.3	33.8	12.6	3.4
Queue Delay	0.0	0.0	0.0	0.0	0.0	0.0	0.0	0.0
Total Delay (s/veh)	33.7	12.7	13.9	35.8	23.3	33.8	12.6	3.4
Queue Length 50th (ft)	57	5	28	12	105	52	36	0
Queue Length 95th (ft)	144	33	98	47	211	135	114	40
Internal Link Dist (ft)		116	246		459		353	
Turn Bay Length (ft)				110		105		
Base Capacity (vph)	676	1040	1000	258	2220	647	2904	1334
Starvation Cap Reductn	0	0	0	0	0	0	0	0
Spillback Cap Reductn	0	0	0	0	0	0	0	0
Storage Cap Reductn	0	0	0	0	0	0	0	0
Reduced v/c Ratio	0.24	0.04	0.20	0.12	0.28	0.22	0.14	0.15
Intersection Summary								

HCM 7th Signalized Intersection Summary Existing + Phase 1 Development Traffic Volumes
 1: Ward Road & Oldham Parkway SAT Peak Hour



Movement	EBL	EBT	EBR	WBL	WBT	WBR	NBL	NBT	NBR	SBL	SBT	SBR
Lane Configurations												
Traffic Volume (veh/h)	154	16	27	37	17	138	30	544	35	135	373	185
Future Volume (veh/h)	154	16	27	37	17	138	30	544	35	135	373	185
Initial Q (Qb), veh	0	0	0	0	0	0	0	0	0	0	0	0
Lane Width Adj.	1.00	1.00	1.00	1.00	1.00	1.00	1.00	1.00	1.00	1.00	1.00	1.00
Ped-Bike Adj(A_pbT)	1.00		1.00	1.00		1.00	1.00		1.00	1.00		1.00
Parking Bus, Adj	1.00	1.00	1.00	1.00	1.00	1.00	1.00	1.00	1.00	1.00	1.00	1.00
Work Zone On Approach		No			No			No			No	
Adj Sat Flow, veh/h/ln	1870	1870	1870	1870	1870	1870	1870	1870	1870	1870	1870	1870
Adj Flow Rate, veh/h	164	17	29	39	18	147	32	579	37	144	397	197
Peak Hour Factor	0.94	0.94	0.94	0.94	0.94	0.94	0.94	0.94	0.94	0.94	0.94	0.94
Percent Heavy Veh, %	2	2	2	2	2	2	2	2	2	2	2	2
Cap, veh/h	380	115	196	125	46	213	64	1106	71	223	1475	658
Arrive On Green	0.19	0.19	0.19	0.19	0.19	0.19	0.04	0.33	0.33	0.13	0.42	0.42
Sat Flow, veh/h	1221	621	1059	196	248	1146	1781	3392	216	1781	3554	1585
Grp Volume(v), veh/h	164	0	46	204	0	0	32	303	313	144	397	197
Grp Sat Flow(s),veh/h/ln	1221	0	1680	1590	0	0	1781	1777	1831	1781	1777	1585
Q Serve(g_s), s	0.2	0.0	1.1	2.7	0.0	0.0	0.8	6.7	6.7	3.7	3.5	4.0
Cycle Q Clear(g_c), s	5.9	0.0	1.1	5.7	0.0	0.0	0.8	6.7	6.7	3.7	3.5	4.0
Prop In Lane	1.00		0.63	0.19		0.72	1.00		0.12	1.00		1.00
Lane Grp Cap(c), veh/h	380	0	311	384	0	0	64	580	597	223	1475	658
V/C Ratio(X)	0.43	0.00	0.15	0.53	0.00	0.00	0.50	0.52	0.52	0.65	0.27	0.30
Avail Cap(c_a), veh/h	1139	0	1356	1352	0	0	344	1486	1532	862	4006	1787
HCM Platoon Ratio	1.00	1.00	1.00	1.00	1.00	1.00	1.00	1.00	1.00	1.00	1.00	1.00
Upstream Filter(I)	1.00	0.00	1.00	1.00	0.00	0.00	1.00	1.00	1.00	1.00	1.00	1.00
Uniform Delay (d), s/veh	18.4	0.0	16.4	18.3	0.0	0.0	22.8	13.2	13.2	20.1	9.3	9.4
Incr Delay (d2), s/veh	0.8	0.0	0.2	1.1	0.0	0.0	5.8	1.0	1.0	3.1	0.1	0.4
Initial Q Delay(d3), s/veh	0.0	0.0	0.0	0.0	0.0	0.0	0.0	0.0	0.0	0.0	0.0	0.0
%ile BackOfQ(95%),veh/ln	2.9	0.0	0.7	3.5	0.0	0.0	0.8	4.2	4.3	2.8	1.9	2.0
Unsig. Movement Delay, s/veh												
LnGrp Delay(d), s/veh	19.2	0.0	16.6	19.4	0.0	0.0	28.6	14.2	14.2	23.2	9.4	9.8
LnGrp LOS	B		B	B			C	B	B	C	A	A
Approach Vol, veh/h		210			204			648			738	
Approach Delay, s/veh		18.6			19.4			14.9			12.2	
Approach LOS		B			B			B			B	
Timer - Assigned Phs	1	2		4	5	6		8				
Phs Duration (G+Y+Rc), s	7.4	25.7		15.0	11.7	21.4		15.0				
Change Period (Y+Rc), s	5.7	5.7		6.1	5.7	5.7		6.1				
Max Green Setting (Gmax), s	9.3	54.3		38.9	23.3	40.3		38.9				
Max Q Clear Time (g_c+I1), s	2.8	6.0		7.7	5.7	8.7		7.9				
Green Ext Time (p_c), s	0.0	5.3		1.3	0.3	5.8		0.9				
Intersection Summary												
HCM 7th Control Delay, s/veh			14.7									
HCM 7th LOS			B									
Notes												
User approved pedestrian interval to be less than phase max green.												

HCM 7th TWSC
2: Jefferson Street & Oldham Parkway

Existing + Phase 1 Development Traffic Volumes
SAT Peak Hour

Intersection												
Int Delay, s/veh	0.4											
Movement	EBL	EBT	EBR	WBL	WBT	WBR	NBL	NBT	NBR	SBL	SBT	SBR
Lane Configurations	↖	↖↗		↖	↖↗				↖			↖
Traffic Vol, veh/h	3	593	12	21	318	307	0	0	23	0	0	3
Future Vol, veh/h	3	593	12	21	318	307	0	0	23	0	0	3
Conflicting Peds, #/hr	0	0	0	0	0	0	0	0	0	0	0	0
Sign Control	Free	Free	Free	Free	Free	Free	Stop	Stop	Stop	Stop	Stop	Stop
RT Channelized	-	-	None	-	-	None	-	-	None	-	-	None
Storage Length	150	-	-	200	-	-	-	-	0	-	-	0
Veh in Median Storage, #	-	0	-	-	0	-	-	0	-	-	0	-
Grade, %	-	0	-	-	0	-	-	0	-	-	0	-
Peak Hour Factor	94	94	94	94	94	94	94	94	94	94	94	94
Heavy Vehicles, %	2	2	2	2	2	2	2	2	2	2	2	2
Mvmt Flow	3	631	13	22	338	327	0	0	24	0	0	3

Major/Minor	Major1			Major2			Minor1			Minor2		
Conflicting Flow All	665	0	0	644	0	0	-	-	322	-	-	332
Stage 1	-	-	-	-	-	-	-	-	-	-	-	-
Stage 2	-	-	-	-	-	-	-	-	-	-	-	-
Critical Hdwy	4.14	-	-	4.14	-	-	-	-	6.94	-	-	6.94
Critical Hdwy Stg 1	-	-	-	-	-	-	-	-	-	-	-	-
Critical Hdwy Stg 2	-	-	-	-	-	-	-	-	-	-	-	-
Follow-up Hdwy	2.22	-	-	2.22	-	-	-	-	3.32	-	-	3.32
Pot Cap-1 Maneuver	920	-	-	937	-	-	0	0	674	0	0	663
Stage 1	-	-	-	-	-	-	0	0	-	0	0	-
Stage 2	-	-	-	-	-	-	0	0	-	0	0	-
Platoon blocked, %	-	-	-	-	-	-	-	-	-	-	-	-
Mov Cap-1 Maneuver	920	-	-	937	-	-	-	-	674	-	-	663
Mov Cap-2 Maneuver	-	-	-	-	-	-	-	-	-	-	-	-
Stage 1	-	-	-	-	-	-	-	-	-	-	-	-
Stage 2	-	-	-	-	-	-	-	-	-	-	-	-

Approach	EB			WB			NB			SB		
HCM Control Delay, s/v	0.04			0.29			10.54			10.45		
HCM LOS							B			B		

Minor Lane/Major Mvmt	NBLn1	EBL	EBT	EBR	WBL	WBT	WBR	SBLn1
Capacity (veh/h)	674	920	-	-	937	-	-	663
HCM Lane V/C Ratio	0.036	0.003	-	-	0.024	-	-	0.005
HCM Control Delay (s/veh)	10.5	8.9	-	-	8.9	-	-	10.5
HCM Lane LOS	B	A	-	-	A	-	-	B
HCM 95th %tile Q(veh)	0.1	0	-	-	0.1	-	-	0

























Queues
3: M-291 & Oldham Parkway

Existing + Phase 1 Development Traffic Volumes
SAT Peak Hour



Lane Group	EBL	EBR	NBL	NBT	SBT	SBR
Lane Group Flow (vph)	378	280	284	1098	1043	385
v/c Ratio	0.71	0.50	0.65	0.29	0.37	0.37
Control Delay (s/veh)	56.1	4.1	53.3	4.8	16.9	3.2
Queue Delay	0.0	0.0	0.0	0.0	0.0	0.0
Total Delay (s/veh)	56.1	4.1	53.3	4.8	16.9	3.2
Queue Length 50th (ft)	145	0	104	76	162	5
Queue Length 95th (ft)	189	15	167	110	229	59
Internal Link Dist (ft)				613	945	
Turn Bay Length (ft)	345		250			180
Base Capacity (vph)	709	633	595	3724	2773	1031
Starvation Cap Reductn	0	0	0	0	0	0
Spillback Cap Reductn	0	0	0	0	0	0
Storage Cap Reductn	0	0	0	0	0	0
Reduced v/c Ratio	0.53	0.44	0.48	0.29	0.38	0.37
Intersection Summary						

HCM 7th Signalized Intersection Summary Existing + Phase 1 Development Traffic Volumes
 3: M-291 & Oldham Parkway SAT Peak Hour

												
Movement	EBL	EBT	EBR	WBL	WBT	WBR	NBL	NBT	NBR	SBL	SBT	SBR
Lane Configurations												
Traffic Volume (veh/h)	355	0	263	0	0	0	267	1032	0	0	980	362
Future Volume (veh/h)	355	0	263	0	0	0	267	1032	0	0	980	362
Initial Q (Qb), veh	0	0	0	0	0	0	0	0	0	0	0	0
Lane Width Adj.	1.00	1.00	1.00	1.00	1.00	1.00	1.00	1.00	1.00	1.00	1.00	1.00
Ped-Bike Adj(A_pbT)	1.00		1.00	1.00		1.00	1.00		1.00	1.00		1.00
Parking Bus, Adj	1.00	1.00	1.00	1.00	1.00	1.00	1.00	1.00	1.00	1.00	1.00	1.00
Work Zone On Approach		No			No			No			No	
Adj Sat Flow, veh/h/ln	1870	1870	1870	1856	1870	1870	1870	1870	1870	1870	1870	1870
Adj Flow Rate, veh/h	378	0	0	0	0	0	284	1098	0	0	1043	0
Peak Hour Factor	0.94	0.94	0.94	0.94	0.94	0.94	0.94	0.94	0.94	0.94	0.94	0.94
Percent Heavy Veh, %	2	2	2	3	2	2	2	2	2	2	2	2
Cap, veh/h	455	250		3	2	1	347	3846		3	3026	
Arrive On Green	0.13	0.00	0.00	0.00	0.00	0.00	0.20	1.00	0.00	0.00	0.59	0.00
Sat Flow, veh/h	3456	1870	1585	3428	1870	1585	3456	5106	1585	3456	5106	1585
Grp Volume(v), veh/h	378	0	0	0	0	0	284	1098	0	0	1043	0
Grp Sat Flow(s),veh/h/ln	1728	1870	1585	1714	1870	1585	1728	1702	1585	1728	1702	1585
Q Serve(g_s), s	12.8	0.0	0.0	0.0	0.0	0.0	9.4	0.0	0.0	0.0	12.5	0.0
Cycle Q Clear(g_c), s	12.8	0.0	0.0	0.0	0.0	0.0	9.4	0.0	0.0	0.0	12.5	0.0
Prop In Lane	1.00		1.00	1.00		1.00	1.00		1.00	1.00		1.00
Lane Grp Cap(c), veh/h	455	250		3	2	1	347	3846		3	3026	
V/C Ratio(X)	0.83	0.00		0.00	0.00	0.00	0.82	0.29		0.00	0.34	
Avail Cap(c_a), veh/h	714	413		143	109	92	599	3846		144	3026	
HCM Platoon Ratio	1.00	1.00	1.00	1.00	1.00	1.00	2.00	2.00	2.00	1.00	1.00	1.00
Upstream Filter(I)	1.00	0.00	0.00	0.00	0.00	0.00	1.00	1.00	0.00	0.00	1.00	0.00
Uniform Delay (d), s/veh	50.8	0.0	0.0	0.0	0.0	0.0	46.9	0.0	0.0	0.0	12.5	0.0
Incr Delay (d2), s/veh	4.8	0.0	0.0	0.0	0.0	0.0	4.7	0.2	0.0	0.0	0.3	0.0
Initial Q Delay(d3), s/veh	0.0	0.0	0.0	0.0	0.0	0.0	0.0	0.0	0.0	0.0	0.0	0.0
%ile BackOfQ(95%),veh/ln	9.9	0.0	0.0	0.0	0.0	0.0	6.9	0.1	0.0	0.0	7.9	0.0
Unsig. Movement Delay, s/veh												
LnGrp Delay(d), s/veh	55.6	0.0	0.0	0.0	0.0	0.0	51.6	0.2	0.0	0.0	12.8	0.0
LnGrp LOS	E						D	A			B	
Approach Vol, veh/h		378			0			1382			1043	
Approach Delay, s/veh		55.6			0.0			10.8			12.8	
Approach LOS		E						B			B	
Timer - Assigned Phs	1	2	3	4	5	6	7	8				
Phs Duration (G+Y+Rc), s	0.0	97.0	0.0	23.0	19.3	77.7	23.0	0.0				
Change Period (Y+Rc), s	6.7	* 6.6	7.3	7.0	7.2	6.6	7.2	* 7				
Max Green Setting (Gmax), s	5.0	* 56	5.0	26.5	20.8	39.6	24.8	* 7				
Max Q Clear Time (g_c+I1), s	0.0	2.0	0.0	0.0	11.4	14.5	14.8	0.0				
Green Ext Time (p_c), s	0.0	13.8	0.0	0.0	0.6	10.1	1.0	0.0				
Intersection Summary												
HCM 7th Control Delay, s/veh			17.6									
HCM 7th LOS			B									
Notes												
User approved pedestrian interval to be less than phase max green.												
* HCM 7th computational engine requires equal clearance times for the phases crossing the barrier.												

Unsignalized Delay for [NBR, EBR, SBR] is excluded from calculations of the approach delay and intersection delay.

Queues
4: Jefferson Street & Persels Road

Existing + Phase 1 Development Traffic Volumes
SAT Peak Hour























Lane Group	EBT	WBL	WBT	NBL	NBT	SBL	SBT
Lane Group Flow (vph)	191	78	210	10	94	4	28
v/c Ratio	0.08	0.08	0.14	0.04	0.34	0.01	0.12
Control Delay (s/veh)	8.6	2.5	3.1	40.5	17.8	39.5	35.5
Queue Delay	0.0	0.0	0.0	0.0	0.0	0.0	0.0
Total Delay (s/veh)	8.6	2.5	3.1	40.5	17.8	39.5	35.5
Queue Length 50th (ft)	25	11	37	7	10	3	13
Queue Length 95th (ft)	55	20	58	20	61	12	41
Internal Link Dist (ft)	356		101		340		315
Turn Bay Length (ft)		175		110		150	
Base Capacity (vph)	2355	923	1420	239	530	232	521
Starvation Cap Reductn	0	0	0	0	0	0	0
Spillback Cap Reductn	0	0	0	0	0	0	0
Storage Cap Reductn	0	0	0	0	0	0	0
Reduced v/c Ratio	0.08	0.08	0.15	0.04	0.18	0.02	0.05
Intersection Summary							

HCM 7th Signalized Intersection Summary
4: Jefferson Street & Persels Road











Existing + Phase 1 Development Traffic Volumes

SAT Peak Hour

												
Movement	EBL	EBT	EBR	WBL	WBT	WBR	NBL	NBT	NBR	SBL	SBT	SBR
Lane Configurations												
Traffic Volume (veh/h)	0	177	3	73	189	8	9	14	74	4	17	9
Future Volume (veh/h)	0	177	3	73	189	8	9	14	74	4	17	9
Initial Q (Qb), veh	0	0	0	0	0	0	0	0	0	0	0	0
Lane Width Adj.	1.00	1.00	1.00	1.00	1.00	1.00	1.00	1.00	1.00	1.00	1.00	1.00
Ped-Bike Adj(A_pbT)	1.00		1.00	1.00		1.00	1.00		1.00	1.00		1.00
Parking Bus, Adj	1.00	1.00	1.00	1.00	1.00	1.00	1.00	1.00	1.00	1.00	1.00	1.00
Work Zone On Approach		No			No			No			No	
Adj Sat Flow, veh/h/ln	1870	1870	1870	1870	1870	1870	1870	1870	1870	1870	1870	1870
Adj Flow Rate, veh/h	0	188	3	78	201	9	10	15	79	4	18	10
Peak Hour Factor	0.94	0.94	0.94	0.94	0.94	0.94	0.94	0.94	0.94	0.94	0.94	0.94
Percent Heavy Veh, %	2	2	2	2	2	2	2	2	2	2	2	2
Cap, veh/h	776	2182	35	898	1294	58	253	35	186	187	139	77
Arrive On Green	0.00	0.61	0.61	0.15	1.00	1.00	0.02	0.14	0.14	0.01	0.12	0.12
Sat Flow, veh/h	1781	3580	57	1781	1776	80	1781	259	1365	1781	1130	628
Grp Volume(v), veh/h	0	93	98	78	0	210	10	0	94	4	0	28
Grp Sat Flow(s),veh/h/ln	1781	1777	1860	1781	0	1856	1781	0	1625	1781	0	1757
Q Serve(g_s), s	0.0	2.6	2.6	1.6	0.0	0.0	0.6	0.0	6.4	0.2	0.0	1.7
Cycle Q Clear(g_c), s	0.0	2.6	2.6	1.6	0.0	0.0	0.6	0.0	6.4	0.2	0.0	1.7
Prop In Lane	1.00		0.03	1.00		0.04	1.00		0.84	1.00		0.36
Lane Grp Cap(c), veh/h	776	1083	1134	898	0	1352	253	0	222	187	0	216
V/C Ratio(X)	0.00	0.09	0.09	0.09	0.00	0.16	0.04	0.00	0.42	0.02	0.00	0.13
Avail Cap(c_a), veh/h	923	1083	1134	969	0	1352	389	0	474	347	0	513
HCM Platoon Ratio	1.00	1.00	1.00	2.00	2.00	2.00	1.00	1.00	1.00	1.00	1.00	1.00
Upstream Filter(I)	0.00	1.00	1.00	1.00	0.00	1.00	1.00	0.00	1.00	1.00	0.00	1.00
Uniform Delay (d), s/veh	0.0	9.7	9.7	5.1	0.0	0.0	43.9	0.0	47.5	45.2	0.0	46.9
Incr Delay (d2), s/veh	0.0	0.2	0.1	0.1	0.0	0.2	0.1	0.0	2.7	0.1	0.0	0.6
Initial Q Delay(d3), s/veh	0.0	0.0	0.0	0.0	0.0	0.0	0.0	0.0	0.0	0.0	0.0	0.0
%ile BackOfQ(95%),veh/ln	0.0	1.8	1.9	0.9	0.0	0.2	0.5	0.0	4.9	0.2	0.0	1.4
Unsig. Movement Delay, s/veh												
LnGrp Delay(d), s/veh	0.0	9.8	9.8	5.2	0.0	0.2	44.0	0.0	50.2	45.3	0.0	47.5
LnGrp LOS		A	A	A		A	D		D	D		D
Approach Vol, veh/h		191			288			104				32
Approach Delay, s/veh		9.8			1.6			49.6				47.2
Approach LOS		A			A			D				D
Timer - Assigned Phs	1	2	3	4	5	6	7	8				
Phs Duration (G+Y+Rc), s	14.3	78.1	6.2	21.4	0.0	92.4	7.8	19.8				
Change Period (Y+Rc), s	5.0	5.0	5.0	5.0	5.0	5.0	5.0	5.0				
Max Green Setting (Gmax), s	14.0	39.0	12.0	35.0	10.0	43.0	12.0	35.0				
Max Q Clear Time (g_c+I1), s	3.6	4.6	2.2	8.4	0.0	2.0	2.6	3.7				
Green Ext Time (p_c), s	0.2	2.1	0.0	0.9	0.0	2.5	0.0	0.2				
Intersection Summary												
HCM 7th Control Delay, s/veh				14.6								
HCM 7th LOS				B								

Queues
5: M-291 & Persels Road/Bailey Road























Existing + Phase 1 Development Traffic Volumes
SAT Peak Hour

											
Lane Group	EBL	EBT	WBL	WBT	WBR	NBL	NBT	NBR	SBL	SBT	SBR
Lane Group Flow (vph)	212	138	119	70	69	26	1167	140	53	1116	271
v/c Ratio	0.61	0.65	0.46	0.44	0.25	0.23	0.42	0.15	0.41	0.54	0.26
Control Delay (s/veh)	54.1	56.1	59.0	60.5	2.2	58.8	18.4	2.4	75.7	10.9	0.8
Queue Delay	0.0	0.0	0.0	0.0	0.0	0.0	0.0	0.0	0.0	0.0	0.0
Total Delay (s/veh)	54.1	56.1	59.0	60.5	2.2	58.8	18.4	2.4	75.7	10.9	0.8
Queue Length 50th (ft)	82	93	45	52	0	20	203	0	42	102	0
Queue Length 95th (ft)	92	161	76	99	0	50	263	27	88	154	10
Internal Link Dist (ft)		341		1242			2412			705	
Turn Bay Length (ft)	200		280		290	310		350	330		
Base Capacity (vph)	400	264	283	200	305	117	2750	928	148	2042	1028
Starvation Cap Reductn	0	0	0	0	0	0	0	0	0	0	0
Spillback Cap Reductn	0	0	0	0	0	0	0	0	0	0	0
Storage Cap Reductn	0	0	0	0	0	0	0	0	0	0	0
Reduced v/c Ratio	0.53	0.52	0.42	0.35	0.23	0.22	0.42	0.15	0.36	0.55	0.26
Intersection Summary											

HCM 7th Signalized Intersection Summary
5: M-291 & Persels Road/Bailey Road

Existing + Phase 1 Development Traffic Volumes

SAT Peak Hour

												
Movement	EBL	EBT	EBR	WBL	WBT	WBR	NBL	NBT	NBR	SBL	SBT	SBR
Lane Configurations												
Traffic Volume (veh/h)	199	92	38	112	66	65	24	1097	132	50	1049	255
Future Volume (veh/h)	199	92	38	112	66	65	24	1097	132	50	1049	255
Initial Q (Qb), veh	0	0	0	0	0	0	0	0	0	0	0	0
Lane Width Adj.	1.00	1.00	1.00	1.00	1.00	1.00	1.00	1.00	1.00	1.00	1.00	1.00
Ped-Bike Adj(A_pbT)	1.00		1.00	1.00		1.00	1.00		1.00	1.00		1.00
Parking Bus, Adj	1.00	1.00	1.00	1.00	1.00	1.00	1.00	1.00	1.00	1.00	1.00	1.00
Work Zone On Approach		No			No			No			No	
Adj Sat Flow, veh/h/ln	1870	1870	1870	1870	1870	1870	1870	1870	1870	1870	1870	1870
Adj Flow Rate, veh/h	212	98	40	119	70	69	26	1167	0	53	1116	0
Peak Hour Factor	0.94	0.94	0.94	0.94	0.94	0.94	0.94	0.94	0.94	0.94	0.94	0.94
Percent Heavy Veh, %	2	2	2	2	2	2	2	2	2	2	2	2
Cap, veh/h	276	121	50	198	139	118	60	2940		86	2095	
Arrive On Green	0.03	0.03	0.03	0.06	0.07	0.07	0.03	0.58	0.00	0.10	1.00	0.00
Sat Flow, veh/h	3456	1262	515	3456	1870	1585	1781	5106	1585	1781	3554	1585
Grp Volume(v), veh/h	212	0	138	119	70	69	26	1167	0	53	1116	0
Grp Sat Flow(s),veh/h/ln	1728	0	1778	1728	1870	1585	1781	1702	1585	1781	1777	1585
Q Serve(g_s), s	7.3	0.0	9.3	4.0	4.3	5.1	1.7	15.1	0.0	3.4	0.0	0.0
Cycle Q Clear(g_c), s	7.3	0.0	9.3	4.0	4.3	5.1	1.7	15.1	0.0	3.4	0.0	0.0
Prop In Lane	1.00		0.29	1.00		1.00	1.00		1.00	1.00		1.00
Lane Grp Cap(c), veh/h	276	0	171	198	139	118	60	2940		86	2095	
V/C Ratio(X)	0.77	0.00	0.81	0.60	0.50	0.59	0.43	0.40		0.62	0.53	
Avail Cap(c_a), veh/h	403	0	252	285	201	170	117	2940		148	2095	
HCM Platoon Ratio	0.33	0.33	0.33	1.00	1.00	1.00	1.00	1.00	1.00	2.00	2.00	2.00
Upstream Filter(I)	1.00	0.00	1.00	1.00	1.00	1.00	1.00	1.00	0.00	1.00	1.00	0.00
Uniform Delay (d), s/veh	57.3	0.0	57.0	55.2	53.4	53.8	56.8	14.0	0.0	53.1	0.0	0.0
Incr Delay (d2), s/veh	5.3	0.0	11.4	2.9	2.8	4.6	4.8	0.4	0.0	6.9	1.0	0.0
Initial Q Delay(d3), s/veh	0.0	0.0	0.0	0.0	0.0	0.0	0.0	0.0	0.0	0.0	0.0	0.0
%ile BackOfQ(95%),veh/ln	6.3	0.0	8.5	3.3	3.8	3.9	1.5	9.3	0.0	2.9	0.5	0.0
Unsig. Movement Delay, s/veh												
LnGrp Delay(d), s/veh	62.6	0.0	68.4	58.2	56.2	58.3	61.7	14.4	0.0	60.1	1.0	0.0
LnGrp LOS	E		E	E	E	E	E	B		E	A	
Approach Vol, veh/h		350			258			1193			1169	
Approach Delay, s/veh		64.9			57.7			15.4			3.7	
Approach LOS		E			E			B			A	
Timer - Assigned Phs	1	2	3	4	5	6	7	8				
Phs Duration (G+Y+Rc), s	11.8	75.6	14.0	18.6	10.2	77.2	16.6	16.0				
Change Period (Y+Rc), s	6.0	6.5	7.1	* 7.1	6.1	* 6.5	7.0	7.1				
Max Green Setting (Gmax), s	10.0	56.5	9.9	* 17	7.9	* 59	14.0	12.9				
Max Q Clear Time (g_c+I1), s	5.4	17.1	6.0	11.3	3.7	2.0	9.3	7.1				
Green Ext Time (p_c), s	0.0	22.9	0.1	0.3	0.0	27.5	0.3	0.2				

Intersection Summary												
HCM 7th Control Delay, s/veh			20.3									
HCM 7th LOS			C									

Notes
 * HCM 7th computational engine requires equal clearance times for the phases crossing the barrier.
 Unsignalized Delay for [NBR, SBR] is excluded from calculations of the approach delay and intersection delay.

Intersection						
Int Delay, s/veh	0.4					
Movement	EBL	EBR	NBL	NBT	SBT	SBR
Lane Configurations		↗		↕	↕	
Traffic Vol, veh/h	0	26	0	321	582	0
Future Vol, veh/h	0	26	0	321	582	0
Conflicting Peds, #/hr	0	0	0	0	0	0
Sign Control	Stop	Stop	Free	Free	Free	Free
RT Channelized	-	None	-	None	-	None
Storage Length	-	0	-	-	-	-
Veh in Median Storage, #	0	-	-	0	0	-
Grade, %	0	-	-	0	0	-
Peak Hour Factor	94	94	94	94	94	94
Heavy Vehicles, %	2	2	2	2	2	2
Mvmt Flow	0	28	0	341	619	0

Major/Minor	Minor2	Major1	Major2		
Conflicting Flow All	-	619	-	0	-
Stage 1	-	-	-	-	-
Stage 2	-	-	-	-	-
Critical Hdwy	-	6.23	-	-	-
Critical Hdwy Stg 1	-	-	-	-	-
Critical Hdwy Stg 2	-	-	-	-	-
Follow-up Hdwy	-	3.319	-	-	-
Pot Cap-1 Maneuver	0	488	0	-	-
Stage 1	0	-	0	-	-
Stage 2	0	-	0	-	-
Platoon blocked, %				-	-
Mov Cap-1 Maneuver	-	488	-	-	-
Mov Cap-2 Maneuver	-	-	-	-	-
Stage 1	-	-	-	-	-
Stage 2	-	-	-	-	-

Approach	EB	NB	SB
HCM Control Delay, s/v12.83		0	0
HCM LOS	B		

Minor Lane/Major Mvmt	NBT EBLn1	SBT
Capacity (veh/h)	- 488	-
HCM Lane V/C Ratio	- 0.057	-
HCM Control Delay (s/veh)	- 12.8	-
HCM Lane LOS	- B	-
HCM 95th %tile Q(veh)	- 0.2	-

HCM 7th TWSC
7: Oldham Parkway & Access 2

Existing + Full Development Traffic Volumes
SAT Peak Hour

Intersection												
Int Delay, s/veh	46.8											
Movement	EBL	EBT	EBR	WBL	WBT	WBR	NBL	NBT	NBR	SBL	SBT	SBR
Lane Configurations	↖	↗		↖	↗		↖	↑	↗	↖	↗	
Traffic Vol, veh/h	21	20	103	327	20	5	134	156	31	5	177	21
Future Vol, veh/h	21	20	103	327	20	5	134	156	31	5	177	21
Conflicting Peds, #/hr	0	0	0	0	0	0	0	0	0	0	0	0
Sign Control	Stop	Stop	Stop	Stop	Stop	Stop	Free	Free	Free	Free	Free	Free
RT Channelized	-	-	None	-	-	None	-	-	None	-	-	None
Storage Length	0	-	-	0	-	-	150	-	0	100	-	-
Veh in Median Storage, #	-	0	-	-	0	-	-	0	-	-	0	-
Grade, %	-	0	-	-	0	-	-	0	-	-	0	-
Peak Hour Factor	98	98	98	98	98	98	98	98	98	98	98	98
Heavy Vehicles, %	2	2	2	2	2	2	2	2	2	2	2	2
Mvmt Flow	21	20	105	334	20	5	137	159	32	5	181	21

Major/Minor	Minor2		Minor1		Major1		Major2					
Conflicting Flow All	644	666	191	634	645	159	202	0	0	191	0	0
Stage 1	202	202	-	433	433	-	-	-	-	-	-	-
Stage 2	443	464	-	201	212	-	-	-	-	-	-	-
Critical Hdwy	7.12	6.52	6.22	7.12	6.52	6.22	4.12	-	-	4.12	-	-
Critical Hdwy Stg 1	6.12	5.52	-	6.12	5.52	-	-	-	-	-	-	-
Critical Hdwy Stg 2	6.12	5.52	-	6.12	5.52	-	-	-	-	-	-	-
Follow-up Hdwy	3.518	4.018	3.318	3.518	4.018	3.318	2.218	-	-	2.218	-	-
Pot Cap-1 Maneuver	386	380	850	392	391	886	1370	-	-	1383	-	-
Stage 1	800	735	-	601	582	-	-	-	-	-	-	-
Stage 2	594	563	-	801	727	-	-	-	-	-	-	-
Platoon blocked, %								-	-	-	-	-
Mov Cap-1 Maneuver	326	341	850	~ 291	351	886	1370	-	-	1383	-	-
Mov Cap-2 Maneuver	326	341	-	~ 291	351	-	-	-	-	-	-	-
Stage 1	797	732	-	541	524	-	-	-	-	-	-	-
Stage 2	511	507	-	680	724	-	-	-	-	-	-	-

Approach	EB	WB	NB	SB
HCM Control Delay, s/v12.23		127.48	3.31	0.19
HCM LOS	B	F		

Minor Lane/Major Mvmt	NBL	NBT	NBR	EBLn1	EBLn2	WBLn1	WBLn2	SBL	SBT	SBR
Capacity (veh/h)	1370	-	-	326	684	291	399	1383	-	-
HCM Lane V/C Ratio	0.1	-	-	0.066	0.183	1.145	0.064	0.004	-	-
HCM Control Delay (s/veh)	7.9	-	-	16.8	11.4	136.1	14.6	7.6	-	-
HCM Lane LOS	A	-	-	C	B	F	B	A	-	-
HCM 95th %tile Q(veh)	0.3	-	-	0.2	0.7	14.1	0.2	0	-	-

Notes
 -: Volume exceeds capacity \$: Delay exceeds 300s +: Computation Not Defined *: All major volume in platoon

HCM 7th TWSC
8: Oldham Parkway & Access 3

Existing + Phase 1 Development Traffic Volumes
SAT Peak Hour

Intersection												
Int Delay, s/veh	3.3											
Movement	EBL	EBT	EBR	WBL	WBT	WBR	NBL	NBT	NBR	SBL	SBT	SBR
Lane Configurations		+			+		+	+			+	
Traffic Vol, veh/h	9	2	34	45	2	3	35	100	47	3	99	11
Future Vol, veh/h	9	2	34	45	2	3	35	100	47	3	99	11
Conflicting Peds, #/hr	0	0	0	0	0	0	0	0	0	0	0	0
Sign Control	Stop	Stop	Stop	Stop	Stop	Stop	Free	Free	Free	Free	Free	Free
RT Channelized	-	-	None	-	-	None	-	-	None	-	-	None
Storage Length	-	-	-	-	-	-	150	-	-	-	-	-
Veh in Median Storage, #	-	0	-	-	0	-	-	0	-	-	0	-
Grade, %	-	0	-	-	0	-	-	0	-	-	0	-
Peak Hour Factor	94	94	94	94	94	94	94	94	94	94	94	94
Heavy Vehicles, %	2	2	2	2	2	2	2	2	2	2	2	2
Mvmt Flow	10	2	36	48	2	3	37	106	50	3	105	12

Major/Minor	Minor2		Minor1		Major1		Major2					
Conflicting Flow All	299	348	111	319	329	131	117	0	0	156	0	0
Stage 1	118	118	-	206	206	-	-	-	-	-	-	-
Stage 2	182	231	-	113	123	-	-	-	-	-	-	-
Critical Hdwy	7.12	6.52	6.22	7.12	6.52	6.22	4.12	-	-	4.12	-	-
Critical Hdwy Stg 1	6.12	5.52	-	6.12	5.52	-	-	-	-	-	-	-
Critical Hdwy Stg 2	6.12	5.52	-	6.12	5.52	-	-	-	-	-	-	-
Follow-up Hdwy	3.518	4.018	3.318	3.518	4.018	3.318	2.218	-	-	2.218	-	-
Pot Cap-1 Maneuver	653	575	942	634	590	918	1471	-	-	1424	-	-
Stage 1	887	798	-	796	731	-	-	-	-	-	-	-
Stage 2	820	713	-	892	794	-	-	-	-	-	-	-
Platoon blocked, %								-	-	-	-	-
Mov Cap-1 Maneuver	630	559	942	591	573	918	1471	-	-	1424	-	-
Mov Cap-2 Maneuver	630	559	-	591	573	-	-	-	-	-	-	-
Stage 1	885	796	-	776	713	-	-	-	-	-	-	-
Stage 2	794	695	-	854	792	-	-	-	-	-	-	-

Approach	EB		WB		NB		SB	
HCM Control Delay, s/v	9.58		11.55		1.44		0.2	
HCM LOS	A		B					

Minor Lane/Major Mvmt	NBL	NBT	NBR	EBLn1	WBLn1	SBL	SBT	SBR
Capacity (veh/h)	1471	-	-	834	603	47	-	-
HCM Lane V/C Ratio	0.025	-	-	0.057	0.088	0.002	-	-
HCM Control Delay (s/veh)	7.5	-	-	9.6	11.5	7.5	0	-
HCM Lane LOS	A	-	-	A	B	A	A	-
HCM 95th %tile Q(veh)	0.1	-	-	0.2	0.3	0	-	-

Intersection						
Int Delay, s/veh	0.6					
Movement	EBT	EBR	WBL	WBT	NBL	NBR
Lane Configurations	T			T	T	
Traffic Vol, veh/h	108	5	5	107	5	5
Future Vol, veh/h	108	5	5	107	5	5
Conflicting Peds, #/hr	0	0	0	0	0	0
Sign Control	Free	Free	Free	Free	Stop	Stop
RT Channelized	-	None	-	None	-	None
Storage Length	-	-	-	-	0	-
Veh in Median Storage, #	0	-	-	0	0	-
Grade, %	0	-	-	0	0	-
Peak Hour Factor	94	94	94	94	94	94
Heavy Vehicles, %	2	2	2	2	2	2
Mvmt Flow	115	5	5	114	5	5

Major/Minor	Major1	Major2	Minor1		
Conflicting Flow All	0	0	120	0	242
Stage 1	-	-	-	-	118
Stage 2	-	-	-	-	124
Critical Hdwy	-	-	4.12	-	6.42
Critical Hdwy Stg 1	-	-	-	-	5.42
Critical Hdwy Stg 2	-	-	-	-	5.42
Follow-up Hdwy	-	-	2.218	-	3.518
Pot Cap-1 Maneuver	-	-	1467	-	746
Stage 1	-	-	-	-	908
Stage 2	-	-	-	-	901
Platoon blocked, %	-	-	-	-	-
Mov Cap-1 Maneuver	-	-	1467	-	743
Mov Cap-2 Maneuver	-	-	-	-	743
Stage 1	-	-	-	-	908
Stage 2	-	-	-	-	898

Approach	EB	WB	NB
HCM Control Delay, s/v	0	0.33	9.4
HCM LOS			A

Minor Lane/Major Mvmt	NBLn1	EBT	EBR	WBL	WBT
Capacity (veh/h)	828	-	-	80	-
HCM Lane V/C Ratio	0.013	-	-	0.004	-
HCM Control Delay (s/veh)	9.4	-	-	7.5	0
HCM Lane LOS	A	-	-	A	A
HCM 95th %tile Q(veh)	0	-	-	0	-

Intersection						
Int Delay, s/veh	0.6					
Movement	EBT	EBR	WBL	WBT	NBL	NBR
Lane Configurations	h			4	Y	
Traffic Vol, veh/h	108	5	5	107	5	5
Future Vol, veh/h	108	5	5	107	5	5
Conflicting Peds, #/hr	0	0	0	0	0	0
Sign Control	Free	Free	Free	Free	Stop	Stop
RT Channelized	-	None	-	None	-	None
Storage Length	-	-	-	-	0	-
Veh in Median Storage, #	0	-	-	0	0	-
Grade, %	0	-	-	0	0	-
Peak Hour Factor	94	94	94	94	94	94
Heavy Vehicles, %	2	2	2	2	2	2
Mvmt Flow	115	5	5	114	5	5

Major/Minor	Major1	Major2	Minor1		
Conflicting Flow All	0	0	120	0	242 118
Stage 1	-	-	-	-	118 -
Stage 2	-	-	-	-	124 -
Critical Hdwy	-	-	4.12	-	6.42 6.22
Critical Hdwy Stg 1	-	-	-	-	5.42 -
Critical Hdwy Stg 2	-	-	-	-	5.42 -
Follow-up Hdwy	-	-	2.218	-	3.518 3.318
Pot Cap-1 Maneuver	-	-	1467	-	746 934
Stage 1	-	-	-	-	908 -
Stage 2	-	-	-	-	901 -
Platoon blocked, %	-	-	-	-	-
Mov Cap-1 Maneuver	-	-	1467	-	743 934
Mov Cap-2 Maneuver	-	-	-	-	743 -
Stage 1	-	-	-	-	908 -
Stage 2	-	-	-	-	898 -

Approach	EB	WB	NB
HCM Control Delay, s/v	0	0.33	9.4
HCM LOS			A

Minor Lane/Major Mvmt	NBLn1	EBT	EBR	WBL	WBT
Capacity (veh/h)	828	-	-	80	-
HCM Lane V/C Ratio	0.013	-	-	0.004	-
HCM Control Delay (s/veh)	9.4	-	-	7.5	0
HCM Lane LOS	A	-	-	A	A
HCM 95th %tile Q(veh)	0	-	-	0	-

Queues
1: Ward Road & Oldham Parkway

Existing + Full Development Traffic Volumes
AM Peak Hour



Lane Group	EBL	EBT	WBT	NBL	NBT	SBL	SBT	SBR
Lane Group Flow (vph)	36	29	228	14	607	170	243	60
v/c Ratio	0.19	0.08	0.59	0.07	0.55	0.48	0.11	0.06
Control Delay (s/veh)	26.2	17.7	21.3	31.7	20.1	29.1	7.6	2.1
Queue Delay	0.0	0.0	0.0	0.0	0.0	0.0	0.0	0.0
Total Delay (s/veh)	26.2	17.7	21.3	31.7	20.1	29.1	7.6	2.1
Queue Length 50th (ft)	11	5	40	5	90	54	15	0
Queue Length 95th (ft)	40	28	124	25	179	135	57	14
Internal Link Dist (ft)		116	246		459		353	
Turn Bay Length (ft)				110		105		
Base Capacity (vph)	507	934	886	435	2765	770	3202	1440
Starvation Cap Reductn	0	0	0	0	0	0	0	0
Spillback Cap Reductn	0	0	0	0	0	0	0	0
Storage Cap Reductn	0	0	0	0	0	0	0	0
Reduced v/c Ratio	0.07	0.03	0.26	0.03	0.22	0.22	0.08	0.04
Intersection Summary								

HCM 7th Signalized Intersection Summary
1: Ward Road & Oldham Parkway

Existing + Full Development Traffic Volumes
AM Peak Hour



Movement	EBL	EBT	EBR	WBL	WBT	WBR	NBL	NBT	NBR	SBL	SBT	SBR	
Lane Configurations													
Traffic Volume (veh/h)	35	17	12	35	28	160	14	556	39	167	238	59	
Future Volume (veh/h)	35	17	12	35	28	160	14	556	39	167	238	59	
Initial Q (Qb), veh	0	0	0	0	0	0	0	0	0	0	0	0	
Lane Width Adj.	1.00	1.00	1.00	1.00	1.00	1.00	1.00	1.00	1.00	1.00	1.00	1.00	
Ped-Bike Adj(A_pbT)	1.00		1.00	1.00		1.00	1.00		1.00	1.00		1.00	
Parking Bus, Adj	1.00	1.00	1.00	1.00	1.00	1.00	1.00	1.00	1.00	1.00	1.00	1.00	
Work Zone On Approach		No			No			No			No		
Adj Sat Flow, veh/h/ln	1870	1870	1870	1870	1870	1870	1870	1870	1870	1870	1870	1870	
Adj Flow Rate, veh/h	36	17	12	36	29	163	14	567	40	170	243	60	
Peak Hour Factor	0.98	0.98	0.98	0.98	0.98	0.98	0.98	0.98	0.98	0.98	0.98	0.98	
Percent Heavy Veh, %	2	2	2	2	2	2	2	2	2	2	2	2	
Cap, veh/h	379	201	142	118	59	226	32	1041	73	227	1489	664	
Arrive On Green	0.20	0.20	0.20	0.20	0.20	0.20	0.02	0.31	0.31	0.13	0.42	0.42	
Sat Flow, veh/h	1191	1020	720	157	301	1149	1781	3367	237	1781	3554	1585	
Grp Volume(v), veh/h	36	0	29	228	0	0	14	299	308	170	243	60	
Grp Sat Flow(s),veh/h/ln	1191	0	1741	1608	0	0	1781	1777	1828	1781	1777	1585	
Q Serve(g_s), s	0.0	0.0	0.6	2.8	0.0	0.0	0.4	6.7	6.7	4.4	2.0	1.1	
Cycle Q Clear(g_c), s	1.2	0.0	0.6	6.3	0.0	0.0	0.4	6.7	6.7	4.4	2.0	1.1	
Prop In Lane	1.00		0.41	0.16		0.71	1.00		0.13	1.00		1.00	
Lane Grp Cap(c), veh/h	379	0	343	404	0	0	32	549	565	227	1489	664	
V/C Ratio(X)	0.10	0.00	0.08	0.56	0.00	0.00	0.44	0.54	0.55	0.75	0.16	0.09	
Avail Cap(c_a), veh/h	915	0	1127	1115	0	0	534	1723	1772	944	4265	1902	
HCM Platoon Ratio	1.00	1.00	1.00	1.00	1.00	1.00	1.00	1.00	1.00	1.00	1.00	1.00	
Upstream Filter(I)	1.00	0.00	1.00	1.00	0.00	0.00	1.00	1.00	1.00	1.00	1.00	1.00	
Uniform Delay (d), s/veh	15.9	0.0	15.7	17.9	0.0	0.0	23.2	13.7	13.7	20.1	8.7	8.4	
Incr Delay (d2), s/veh	0.1	0.0	0.1	1.2	0.0	0.0	9.4	1.2	1.2	4.9	0.1	0.1	
Initial Q Delay(d3), s/veh	0.0	0.0	0.0	0.0	0.0	0.0	0.0	0.0	0.0	0.0	0.0	0.0	
%ile BackOfQ(95%),veh/ln	0.6	0.0	0.4	3.8	0.0	0.0	0.4	4.2	4.4	3.4	1.1	0.5	
Unsig. Movement Delay, s/veh													
LnGrp Delay(d), s/veh	16.0	0.0	15.8	19.1	0.0	0.0	32.6	14.9	14.9	25.0	8.7	8.5	
LnGrp LOS	B		B	B			C	B	B	C	A	A	
Approach Vol, veh/h	65						228		621		473		
Approach Delay, s/veh	15.9						19.1		15.3		14.5		
Approach LOS	B						B		B		B		
Timer - Assigned Phs	1	2	4		5	6	8						
Phs Duration (G+Y+Rc), s	6.5	25.7	15.5		11.8	20.5	15.5						
Change Period (Y+Rc), s	5.7	5.7	6.1		5.7	5.7	6.1						
Max Green Setting (Gmax), s	14.3	57.3	30.9		25.3	46.3	30.9						
Max Q Clear Time (g_c+I1), s	2.4	4.0	8.3		6.4	8.7	3.2						
Green Ext Time (p_c), s	0.0	2.7	1.3		0.4	5.9	0.2						
Intersection Summary													
HCM 7th Control Delay, s/veh			15.7										
HCM 7th LOS			B										
Notes													
User approved pedestrian interval to be less than phase max green.													

HCM 7th TWSC
2: Jefferson Street & Oldham Parkway

Existing + Full Development Traffic Volumes
AM Peak Hour

Intersection												
Int Delay, s/veh	4.2											
Movement	EBL	EBT	EBR	WBL	WBT	WBR	NBL	NBT	NBR	SBL	SBT	SBR
Lane Configurations	↖	↖↗		↖	↖↗				↖			↖
Traffic Vol, veh/h	3	533	47	393	403	323	0	0	285	0	0	2
Future Vol, veh/h	3	533	47	393	403	323	0	0	285	0	0	2
Conflicting Peds, #/hr	0	0	0	0	0	0	0	0	0	0	0	0
Sign Control	Free	Free	Free	Free	Free	Free	Stop	Stop	Stop	Stop	Stop	Stop
RT Channelized	-	-	None	-	-	None	-	-	None	-	-	None
Storage Length	150	-	-	200	-	-	-	-	0	-	-	0
Veh in Median Storage, #	-	0	-	-	0	-	-	0	-	-	0	-
Grade, %	-	0	-	-	0	-	-	0	-	-	0	-
Peak Hour Factor	98	98	98	98	98	98	98	98	98	98	98	98
Heavy Vehicles, %	2	2	2	2	2	2	2	2	2	2	2	2
Mvmt Flow	3	544	48	401	411	330	0	0	291	0	0	2

Major/Minor	Major1		Major2		Minor1		Minor2					
Conflicting Flow All	741	0	0	592	0	0	-	-	296	-	-	370
Stage 1	-	-	-	-	-	-	-	-	-	-	-	-
Stage 2	-	-	-	-	-	-	-	-	-	-	-	-
Critical Hdwy	4.14	-	-	4.14	-	-	-	-	6.94	-	-	6.94
Critical Hdwy Stg 1	-	-	-	-	-	-	-	-	-	-	-	-
Critical Hdwy Stg 2	-	-	-	-	-	-	-	-	-	-	-	-
Follow-up Hdwy	2.22	-	-	2.22	-	-	-	-	3.32	-	-	3.32
Pot Cap-1 Maneuver	862	-	-	980	-	-	0	0	700	0	0	627
Stage 1	-	-	-	-	-	-	0	0	-	0	0	-
Stage 2	-	-	-	-	-	-	0	0	-	0	0	-
Platoon blocked, %	-	-	-	-	-	-	-	-	-	-	-	-
Mov Cap-1 Maneuver	862	-	-	980	-	-	-	-	700	-	-	627
Mov Cap-2 Maneuver	-	-	-	-	-	-	-	-	-	-	-	-
Stage 1	-	-	-	-	-	-	-	-	-	-	-	-
Stage 2	-	-	-	-	-	-	-	-	-	-	-	-

Approach	EB		WB		NB		SB	
HCM Control Delay, s/v	0.05		3.93		13.74		10.76	
HCM LOS					B		B	

Minor Lane/Major Mvmt	NBLn1	EBL	EBT	EBR	WBL	WBT	WBR	SBLn1
Capacity (veh/h)	700	862	-	-	980	-	-	627
HCM Lane V/C Ratio	0.415	0.004	-	-	0.409	-	-	0.003
HCM Control Delay (s/veh)	13.7	9.2	-	-	11.2	-	-	10.8
HCM Lane LOS	B	A	-	-	B	-	-	B
HCM 95th %tile Q(veh)	2	0	-	-	2	-	-	0

Queues
3: M-291 & Oldham Parkway

Existing + Full Development Traffic Volumes
AM Peak Hour



Lane Group	EBL	EBR	NBL	NBT	SBT	SBR
Lane Group Flow (vph)	612	266	320	1559	1206	784
v/c Ratio	0.85	0.40	0.75	0.45	0.48	0.69
Control Delay (s/veh)	58.3	1.8	49.9	1.4	21.4	7.2
Queue Delay	0.0	0.0	0.0	0.0	0.0	0.0
Total Delay (s/veh)	58.3	1.8	49.9	1.4	21.4	7.2
Queue Length 50th (ft)	232	0	133	7	230	46
Queue Length 95th (ft)	300	0	m180	12	273	180
Internal Link Dist (ft)				1398	887	
Turn Bay Length (ft)	345		250			180
Base Capacity (vph)	766	686	452	3444	2507	1123
Starvation Cap Reductn	0	0	0	0	0	0
Spillback Cap Reductn	0	0	0	0	0	0
Storage Cap Reductn	0	0	0	0	0	0
Reduced v/c Ratio	0.80	0.39	0.71	0.45	0.48	0.70

Intersection Summary

























m Volume for 95th percentile queue is metered by upstream signal.

HCM 7th Signalized Intersection Summary

3: M-291 & Oldham Parkway

Existing + Full Development Traffic Volumes

AM Peak Hour

												
Movement	EBL	EBT	EBR	WBL	WBT	WBR	NBL	NBT	NBR	SBL	SBT	SBR
Lane Configurations												
Traffic Volume (veh/h)	600	0	261	0	0	0	314	1528	0	0	1182	768
Future Volume (veh/h)	600	0	261	0	0	0	314	1528	0	0	1182	768
Initial Q (Qb), veh	0	0	0	0	0	0	0	0	0	0	0	0
Lane Width Adj.	1.00	1.00	1.00	1.00	1.00	1.00	1.00	1.00	1.00	1.00	1.00	1.00
Ped-Bike Adj(A_pbT)	1.00		1.00	1.00		1.00	1.00		1.00	1.00		1.00
Parking Bus, Adj	1.00	1.00	1.00	1.00	1.00	1.00	1.00	1.00	1.00	1.00	1.00	1.00
Work Zone On Approach		No			No			No			No	
Adj Sat Flow, veh/h/ln	1870	1870	1870	1870	1870	1870	1870	1870	1870	1870	1870	1870
Adj Flow Rate, veh/h	612	0	0	0	0	0	320	1559	0	0	1206	0
Peak Hour Factor	0.98	0.98	0.98	0.98	0.98	0.98	0.98	0.98	0.98	0.98	0.98	0.98
Percent Heavy Veh, %	2	2	2	2	2	2	2	2	2	2	2	2
Cap, veh/h	683	373		3	2	1	1118	3484		3	1551	
Arrive On Green	0.20	0.00	0.00	0.00	0.00	0.00	0.65	1.00	0.00	0.00	0.30	0.00
Sat Flow, veh/h	3456	1870	1585	3456	1870	1585	3456	5106	1585	3456	5106	1585
Grp Volume(v), veh/h	612	0	0	0	0	0	320	1559	0	0	1206	0
Grp Sat Flow(s),veh/h/ln	1728	1870	1585	1728	1870	1585	1728	1702	1585	1728	1702	1585
Q Serve(g_s), s	20.7	0.0	0.0	0.0	0.0	0.0	4.8	0.0	0.0	0.0	25.8	0.0
Cycle Q Clear(g_c), s	20.7	0.0	0.0	0.0	0.0	0.0	4.8	0.0	0.0	0.0	25.8	0.0
Prop In Lane	1.00		1.00	1.00		1.00	1.00		1.00	1.00		1.00
Lane Grp Cap(c), veh/h	683	373		3	2	1	1118	3484		3	1551	
V/C Ratio(X)	0.90	0.00		0.00	0.00	0.00	0.29	0.45		0.00	0.78	
Avail Cap(c_a), veh/h	772	444		144	109	92	1118	3484		144	1813	
HCM Platoon Ratio	1.00	1.00	1.00	1.00	1.00	1.00	2.00	2.00	2.00	1.00	1.00	1.00
Upstream Filter(I)	1.00	0.00	0.00	0.00	0.00	0.00	0.73	0.73	0.00	0.00	1.00	0.00
Uniform Delay (d), s/veh	46.9	0.0	0.0	0.0	0.0	0.0	15.2	0.0	0.0	0.0	38.1	0.0
Incr Delay (d2), s/veh	12.1	0.0	0.0	0.0	0.0	0.0	0.1	0.3	0.0	0.0	3.9	0.0
Initial Q Delay(d3), s/veh	0.0	0.0	0.0	0.0	0.0	0.0	0.0	0.0	0.0	0.0	0.0	0.0
%ile BackOfQ(95%),veh/ln	15.3	0.0	0.0	0.0	0.0	0.0	3.0	0.2	0.0	0.0	16.3	0.0
Unsig. Movement Delay, s/veh												
LnGrp Delay(d), s/veh	59.1	0.0	0.0	0.0	0.0	0.0	15.3	0.3	0.0	0.0	42.0	0.0
LnGrp LOS	E						B	A			D	
Approach Vol, veh/h		612			0			1879			1206	
Approach Delay, s/veh		59.1			0.0			2.9			42.0	
Approach LOS		E						A			D	
Timer - Assigned Phs	1	2	3	4	5	6	7	8				
Phs Duration (G+Y+Rc), s	0.0	89.1	0.0	30.9	46.0	43.1	30.9	0.0				
Change Period (Y+Rc), s	6.7	* 7.2	7.3	7.0	7.2	6.6	7.2	* 7				
Max Green Setting (Gmax), s	5.0	* 54	5.0	28.5	15.8	42.6	26.8	* 7				
Max Q Clear Time (g_c+I1), s	0.0	2.0	0.0	0.0	6.8	27.8	22.7	0.0				
Green Ext Time (p_c), s	0.0	23.4	0.0	0.0	0.7	8.6	1.0	0.0				
Intersection Summary												
HCM 7th Control Delay, s/veh			24.9									
HCM 7th LOS			C									
Notes												
User approved pedestrian interval to be less than phase max green.												
* HCM 7th computational engine requires equal clearance times for the phases crossing the barrier.												

Unsignalized Delay for [NBR, EBR, SBR] is excluded from calculations of the approach delay and intersection delay.

Queues
4: Jefferson Street & Persels Road





















Existing + Full Development Traffic Volumes
AM Peak Hour



Lane Group	EBL	EBT	WBL	WBT	NBL	NBT	SBL	SBT
Lane Group Flow (vph)	64	277	297	284	15	266	216	287
v/c Ratio	0.12	0.19	0.44	0.33	0.04	0.71	0.61	0.51
Control Delay (s/veh)	16.7	25.9	24.1	18.3	22.4	37.7	34.9	35.8
Queue Delay	0.0	0.0	0.0	0.0	0.0	0.0	0.0	0.0
Total Delay (s/veh)	16.7	25.9	24.1	18.3	22.4	37.7	34.9	35.8
Queue Length 50th (ft)	21	67	127	116	8	116	123	160
Queue Length 95th (ft)	54	128	268	244	19	194	156	249
Internal Link Dist (ft)		1272		101		1173		315
Turn Bay Length (ft)	110		175		110		150	
Base Capacity (vph)	505	1428	724	848	330	536	353	585
Starvation Cap Reductn	0	0	0	0	0	0	0	0
Spillback Cap Reductn	0	0	0	0	0	0	0	0
Storage Cap Reductn	0	0	0	0	0	0	0	0
Reduced v/c Ratio	0.13	0.19	0.41	0.33	0.05	0.50	0.61	0.49
Intersection Summary								

HCM 7th Signalized Intersection Summary
4: Jefferson Street & Persels Road

Existing + Full Development Traffic Volumes
AM Peak Hour

												
Movement	EBL	EBT	EBR	WBL	WBT	WBR	NBL	NBT	NBR	SBL	SBT	SBR
Lane Configurations												
Traffic Volume (veh/h)	63	238	33	291	220	59	15	71	190	212	201	80
Future Volume (veh/h)	63	238	33	291	220	59	15	71	190	212	201	80
Initial Q (Qb), veh	0	0	0	0	0	0	0	0	0	0	0	0
Lane Width Adj.	1.00	1.00	1.00	1.00	1.00	1.00	1.00	1.00	1.00	1.00	1.00	1.00
Ped-Bike Adj(A_pbT)	1.00		1.00	1.00		1.00	1.00		1.00	1.00		1.00
Parking Bus, Adj	1.00	1.00	1.00	1.00	1.00	1.00	1.00	1.00	1.00	1.00	1.00	1.00
Work Zone On Approach		No			No			No			No	
Adj Sat Flow, veh/h/ln	1870	1870	1870	1870	1870	1870	1870	1870	1870	1870	1870	1870
Adj Flow Rate, veh/h	64	243	34	297	224	60	15	72	194	216	205	82
Peak Hour Factor	0.98	0.98	0.98	0.98	0.98	0.98	0.98	0.98	0.98	0.98	0.98	0.98
Percent Heavy Veh, %	2	2	2	2	2	2	2	2	2	2	2	2
Cap, veh/h	668	392	54	823	271	73	258	85	229	296	341	136
Arrive On Green	0.34	0.13	0.13	0.54	0.25	0.25	0.03	0.19	0.19	0.11	0.27	0.27
Sat Flow, veh/h	1781	3136	433	1781	1421	381	1781	448	1206	1781	1271	508
Grp Volume(v), veh/h	64	136	141	297	0	284	15	0	266	216	0	287
Grp Sat Flow(s),veh/h/ln	1781	1777	1792	1781	0	1802	1781	0	1653	1781	0	1779
Q Serve(g_s), s	0.0	8.7	8.9	3.4	0.0	17.9	0.8	0.0	18.6	11.3	0.0	16.9
Cycle Q Clear(g_c), s	0.0	8.7	8.9	3.4	0.0	17.9	0.8	0.0	18.6	11.3	0.0	16.9
Prop In Lane	1.00		0.24	1.00		0.21	1.00		0.73	1.00		0.29
Lane Grp Cap(c), veh/h	668	222	224	823	0	344	258	0	314	296	0	477
V/C Ratio(X)	0.10	0.61	0.63	0.36	0.00	0.83	0.06	0.00	0.85	0.73	0.00	0.60
Avail Cap(c_a), veh/h	668	518	523	823	0	646	348	0	455	306	0	548
HCM Platoon Ratio	1.00	1.00	1.00	1.33	1.33	1.33	1.00	1.00	1.00	1.00	1.00	1.00
Upstream Filter(I)	1.00	1.00	1.00	1.00	0.00	1.00	1.00	0.00	1.00	1.00	0.00	1.00
Uniform Delay (d), s/veh	26.0	49.8	49.8	16.3	0.0	42.9	36.8	0.0	47.0	34.0	0.0	38.3
Incr Delay (d2), s/veh	0.1	12.1	12.6	0.4	0.0	19.7	0.1	0.0	14.6	9.0	0.0	2.7
Initial Q Delay(d3), s/veh	0.0	0.0	0.0	0.0	0.0	0.0	0.0	0.0	0.0	0.0	0.0	0.0
%ile BackOfQ(95%),veh/ln	2.2	8.1	8.3	7.2	0.0	14.3	0.6	0.0	13.7	9.4	0.0	12.2
Unsig. Movement Delay, s/veh												
LnGrp Delay(d), s/veh	26.1	61.8	62.4	16.6	0.0	62.6	37.0	0.0	61.6	43.0	0.0	41.1
LnGrp LOS	C	E	E	B		E	D		E	D		D
Approach Vol, veh/h		341			581			281				503
Approach Delay, s/veh		55.4			39.1			60.3				41.9
Approach LOS		E			D			E				D
Timer - Assigned Phs	1	2	3	4	5	6	7	8				
Phs Duration (G+Y+Rc), s	53.9	20.0	18.4	27.8	46.0	27.9	8.9	37.2				
Change Period (Y+Rc), s	5.0	5.0	5.0	5.0	5.0	5.0	5.0	5.0				
Max Green Setting (Gmax), s	18.0	35.0	14.0	33.0	10.0	43.0	10.0	37.0				
Max Q Clear Time (g_c+I1), s	5.4	10.9	13.3	20.6	2.0	19.9	2.8	18.9				
Green Ext Time (p_c), s	1.1	2.9	0.1	2.1	0.1	3.1	0.0	2.8				
Intersection Summary												
HCM 7th Control Delay, s/veh			46.7									
HCM 7th LOS			D									

Queues

Existing + Full Development Traffic Volumes

5: M-291 & Persels Road/Bailey Road

AM Peak Hour



























Lane Group	EBL	EBT	EBR	WBL	WBT	WBR	NBL	NBT	NBR	SBL	SBT	SBR
Lane Group Flow (vph)	393	115	144	178	147	67	158	1497	273	50	1017	493
v/c Ratio	0.85	0.58	0.41	0.38	0.74	0.18	0.69	0.60	0.29	0.41	0.69	0.54
Control Delay (s/veh)	65.9	52.8	8.7	50.8	73.9	1.1	66.2	24.3	3.1	46.0	16.6	3.1
Queue Delay	0.0	0.0	0.0	0.0	0.0	0.0	0.0	0.0	0.0	0.0	0.0	0.0
Total Delay (s/veh)	65.9	52.8	8.7	50.8	73.9	1.1	66.2	24.3	3.1	46.0	16.6	3.1
Queue Length 50th (ft)	162	91	8	64	111	0	118	319	0	38	103	15
Queue Length 95th (ft)	#242	m137	30	105	#197	0	187	370	47	81	443	40
Internal Link Dist (ft)		341			1421			2289			1398	
Turn Bay Length (ft)	200		150	280		290	310		350	330		
Base Capacity (vph)	463	326	444	460	215	365	278	2495	916	126	1463	910
Starvation Cap Reductn	0	0	0	0	0	0	0	0	0	0	0	0
Spillback Cap Reductn	0	0	0	0	0	0	0	0	0	0	0	0
Storage Cap Reductn	0	0	0	0	0	0	0	0	0	0	0	0
Reduced v/c Ratio	0.85	0.35	0.32	0.39	0.68	0.18	0.57	0.60	0.30	0.40	0.70	0.54

Intersection Summary

- # 95th percentile volume exceeds capacity, queue may be longer.
Queue shown is maximum after two cycles.
- m Volume for 95th percentile queue is metered by upstream signal.

HCM 7th Signalized Intersection Summary
5: M-291 & Persels Road/Bailey Road

Existing + Full Development Traffic Volumes
AM Peak Hour

												
Movement	EBL	EBT	EBR	WBL	WBT	WBR	NBL	NBT	NBR	SBL	SBT	SBR
Lane Configurations												
Traffic Volume (veh/h)	385	113	141	174	144	66	155	1467	268	49	997	483
Future Volume (veh/h)	385	113	141	174	144	66	155	1467	268	49	997	483
Initial Q (Qb), veh	0	0	0	0	0	0	0	0	0	0	0	0
Lane Width Adj.	1.00	1.00	1.00	1.00	1.00	1.00	1.00	1.00	1.00	1.00	1.00	1.00
Ped-Bike Adj(A_pbT)	1.00		0.98	1.00		1.00	1.00		1.00	1.00		1.00
Parking Bus, Adj	1.00	1.00	1.00	1.00	1.00	1.00	1.00	1.00	1.00	1.00	1.00	1.00
Work Zone On Approach		No			No			No			No	
Adj Sat Flow, veh/h/ln	1870	1870	1856	1870	1870	1870	1870	1870	1870	1870	1870	1870
Adj Flow Rate, veh/h	393	115	144	178	147	67	158	1497	0	50	1017	0
Peak Hour Factor	0.98	0.98	0.98	0.98	0.98	0.98	0.98	0.98	0.98	0.98	0.98	0.98
Percent Heavy Veh, %	2	2	3	2	2	2	2	2	2	2	2	2
Cap, veh/h	450	176	145	459	179	152	187	2147		233	1599	
Arrive On Green	0.04	0.03	0.03	0.13	0.10	0.10	0.10	0.42	0.00	0.26	0.90	0.00
Sat Flow, veh/h	3456	1870	1542	3456	1870	1585	1781	5106	1585	1781	3554	1585
Grp Volume(v), veh/h	393	115	144	178	147	67	158	1497	0	50	1017	0
Grp Sat Flow(s),veh/h/ln	1728	1870	1542	1728	1870	1585	1781	1702	1585	1781	1777	1585
Q Serve(g_s), s	13.6	7.3	8.6	5.7	9.3	4.8	10.5	28.8	0.0	2.6	8.0	0.0
Cycle Q Clear(g_c), s	13.6	7.3	8.6	5.7	9.3	4.8	10.5	28.8	0.0	2.6	8.0	0.0
Prop In Lane	1.00		1.00	1.00		1.00	1.00		1.00	1.00		1.00
Lane Grp Cap(c), veh/h	450	176	145	459	179	152	187	2147		233	1599	
V/C Ratio(X)	0.87	0.65	0.99	0.39	0.82	0.44	0.85	0.70		0.21	0.64	
Avail Cap(c_a), veh/h	461	327	270	459	217	184	281	2336		233	1599	
HCM Platoon Ratio	0.33	0.33	0.33	1.00	1.00	1.00	1.00	1.00	1.00	2.00	2.00	2.00
Upstream Filter(I)	1.00	1.00	1.00	1.00	1.00	1.00	1.00	1.00	0.00	0.88	0.88	0.00
Uniform Delay (d), s/veh	56.4	56.2	33.9	47.6	53.3	51.2	52.8	28.5	0.0	39.5	3.7	0.0
Incr Delay (d2), s/veh	16.4	4.0	36.6	0.5	18.6	2.0	13.9	1.9	0.0	0.4	1.7	0.0
Initial Q Delay(d3), s/veh	0.0	0.0	0.0	0.0	0.0	0.0	0.0	0.0	0.0	0.0	0.0	0.0
%ile BackOfQ(95%),veh/ln	11.8	6.8	8.5	4.4	9.0	3.6	9.0	17.1	0.0	2.0	3.3	0.0
Unsig. Movement Delay, s/veh												
LnGrp Delay(d), s/veh	72.8	60.2	70.4	48.1	71.9	53.2	66.6	30.4	0.0	39.9	5.4	0.0
LnGrp LOS	E	E	E	D	E	D	E	C		D	A	
Approach Vol, veh/h		652			392			1655			1067	
Approach Delay, s/veh		70.1			57.9			33.9			7.0	
Approach LOS		E			E			C			A	
Timer - Assigned Phs	1	2	3	4	5	6	7	8				
Phs Duration (G+Y+Rc), s	21.7	57.0	23.0	18.3	18.7	60.0	22.7	18.6				
Change Period (Y+Rc), s	6.0	6.5	7.1	7.0	6.1	6.0	7.1	* 7.1				
Max Green Setting (Gmax), s	8.6	54.9	8.9	21.0	18.9	45.0	16.0	* 14				
Max Q Clear Time (g_c+I1), s	4.6	30.8	7.7	10.6	12.5	10.0	15.6	11.3				
Green Ext Time (p_c), s	0.0	19.6	0.1	0.8	0.2	19.0	0.1	0.2				
Intersection Summary												
HCM 7th Control Delay, s/veh			35.0									
HCM 7th LOS			D									
Notes												
User approved pedestrian interval to be less than phase max green.												
* HCM 7th computational engine requires equal clearance times for the phases crossing the barrier.												

Unsignalized Delay for [NBR, SBR] is excluded from calculations of the approach delay and intersection delay.

Intersection						
Int Delay, s/veh	0.3					
Movement	EBL	EBR	NBL	NBT	SBT	SBR
Lane Configurations		↗		↕↕	↕	
Traffic Vol, veh/h	0	21	0	405	562	0
Future Vol, veh/h	0	21	0	405	562	0
Conflicting Peds, #/hr	0	0	0	0	0	0
Sign Control	Stop	Stop	Free	Free	Free	Free
RT Channelized	-	None	-	None	-	None
Storage Length	-	0	-	-	-	-
Veh in Median Storage, #	0	-	-	0	0	-
Grade, %	0	-	-	0	0	-
Peak Hour Factor	98	98	98	98	98	98
Heavy Vehicles, %	2	2	2	2	2	2
Mvmt Flow	0	21	0	413	573	0

Major/Minor	Minor2	Major1	Major2		
Conflicting Flow All	-	573	-	0	-
Stage 1	-	-	-	-	-
Stage 2	-	-	-	-	-
Critical Hdwy	-	6.23	-	-	-
Critical Hdwy Stg 1	-	-	-	-	-
Critical Hdwy Stg 2	-	-	-	-	-
Follow-up Hdwy	-	3.319	-	-	-
Pot Cap-1 Maneuver	0	518	0	-	-
Stage 1	0	-	0	-	-
Stage 2	0	-	0	-	-
Platoon blocked, %				-	-
Mov Cap-1 Maneuver	-	518	-	-	-
Mov Cap-2 Maneuver	-	-	-	-	-
Stage 1	-	-	-	-	-
Stage 2	-	-	-	-	-

Approach	EB	NB	SB
HCM Control Delay, s/v12.25		0	0
HCM LOS	B		

Minor Lane/Major Mvmt	NBT EBLn1	SBT
Capacity (veh/h)	- 518	-
HCM Lane V/C Ratio	- 0.041	-
HCM Control Delay (s/veh)	- 12.3	-
HCM Lane LOS	- B	-
HCM 95th %tile Q(veh)	- 0.1	-

Queues
7: Oldham Parkway & Access 2























Existing + Full Development Traffic Volumes
AM Peak Hour



Lane Group	EBL	EBT	WBL	WBT	NBL	NBT	NBR	SBL	SBT
Lane Group Flow (vph)	17	106	307	24	135	246	33	5	202
v/c Ratio	0.02	0.14	0.56	0.03	0.35	0.41	0.06	0.01	0.34
Control Delay (s/veh)	7.0	3.3	13.2	6.4	14.4	13.5	5.4	10.8	12.5
Queue Delay	0.0	0.0	0.0	0.0	0.0	0.0	0.0	0.0	0.0
Total Delay (s/veh)	7.0	3.3	13.2	6.4	14.4	13.5	5.4	10.8	12.5
Queue Length 50th (ft)	2	2	38	2	19	35	0	1	27
Queue Length 95th (ft)	11	22	122	12	70	110	14	7	90
Internal Link Dist (ft)		202		215		382			306
Turn Bay Length (ft)					150			100	
Base Capacity (vph)	1382	1635	1283	1816	1106	1753	1492	1062	1725
Starvation Cap Reductn	0	0	0	0	0	0	0	0	0
Spillback Cap Reductn	0	0	0	0	0	0	0	0	0
Storage Cap Reductn	0	0	0	0	0	0	0	0	0
Reduced v/c Ratio	0.01	0.06	0.24	0.01	0.12	0.14	0.02	0.00	0.12
Intersection Summary									

HCM 7th Signalized Intersection Summary
7: Oldham Parkway & Access 2

Existing + Full Development Traffic Volumes
AM Peak Hour

												
Movement	EBL	EBT	EBR	WBL	WBT	WBR	NBL	NBT	NBR	SBL	SBT	SBR
Lane Configurations												
Traffic Volume (veh/h)	17	20	84	301	20	4	132	241	32	5	177	21
Future Volume (veh/h)	17	20	84	301	20	4	132	241	32	5	177	21
Initial Q (Qb), veh	0	0	0	0	0	0	0	0	0	0	0	0
Lane Width Adj.	1.00	1.00	1.00	1.00	1.00	1.00	1.00	1.00	1.00	1.00	1.00	1.00
Ped-Bike Adj(A_pbT)	1.00		1.00	1.00		1.00	1.00		1.00	1.00		1.00
Parking Bus, Adj	1.00	1.00	1.00	1.00	1.00	1.00	1.00	1.00	1.00	1.00	1.00	1.00
Work Zone On Approach		No			No			No			No	
Adj Sat Flow, veh/h/ln	1870	1870	1870	1870	1870	1870	1870	1870	1870	1870	1870	1870
Adj Flow Rate, veh/h	17	20	86	307	20	4	135	246	0	5	181	21
Peak Hour Factor	0.98	0.98	0.98	0.98	0.98	0.98	0.98	0.98	0.98	0.98	0.98	0.98
Percent Heavy Veh, %	2	2	2	2	2	2	2	2	2	2	2	2
Cap, veh/h	741	111	478	660	547	109	535	605		503	532	62
Arrive On Green	0.36	0.36	0.36	0.36	0.36	0.36	0.32	0.32	0.00	0.32	0.32	0.32
Sat Flow, veh/h	1387	308	1324	1288	1513	303	1180	1870	1585	1134	1645	191
Grp Volume(v), veh/h	17	0	106	307	0	24	135	246	0	5	0	202
Grp Sat Flow(s),veh/h/ln	1387	0	1632	1288	0	1816	1180	1870	1585	1134	0	1836
Q Serve(g_s), s	0.2	0.0	1.3	6.1	0.0	0.2	2.8	2.9	0.0	0.1	0.0	2.4
Cycle Q Clear(g_c), s	0.5	0.0	1.3	7.4	0.0	0.2	5.2	2.9	0.0	3.0	0.0	2.4
Prop In Lane	1.00		0.81	1.00		0.17	1.00		1.00	1.00		0.10
Lane Grp Cap(c), veh/h	741	0	590	660	0	656	535	605		503	0	594
V/C Ratio(X)	0.02	0.00	0.18	0.47	0.00	0.04	0.25	0.41		0.01	0.00	0.34
Avail Cap(c_a), veh/h	3664	0	4028	3373	0	4482	1827	2652		1743	0	2603
HCM Platoon Ratio	1.00	1.00	1.00	1.00	1.00	1.00	1.00	1.00	1.00	1.00	1.00	1.00
Upstream Filter(I)	1.00	0.00	1.00	1.00	0.00	1.00	1.00	1.00	0.00	1.00	0.00	1.00
Uniform Delay (d), s/veh	6.1	0.0	6.2	8.8	0.0	5.9	9.3	7.5	0.0	8.7	0.0	7.3
Incr Delay (d2), s/veh	0.0	0.0	0.1	0.5	0.0	0.0	0.2	0.4	0.0	0.0	0.0	0.3
Initial Q Delay(d3), s/veh	0.0	0.0	0.0	0.0	0.0	0.0	0.0	0.0	0.0	0.0	0.0	0.0
%ile BackOfQ(95%),veh/ln	0.1	0.0	0.5	2.0	0.0	0.1	0.9	1.4	0.0	0.0	0.0	1.1
Unsig. Movement Delay, s/veh												
LnGrp Delay(d), s/veh	6.1	0.0	6.4	9.3	0.0	5.9	9.6	8.0	0.0	8.7	0.0	7.7
LnGrp LOS	A		A	A		A	A	A		A		A
Approach Vol, veh/h		123			331			381			207	
Approach Delay, s/veh		6.3			9.0			8.5			7.7	
Approach LOS		A			A			A			A	
Timer - Assigned Phs		2		4		6		8				
Phs Duration (G+Y+Rc), s		13.7		14.8		13.7		14.8				
Change Period (Y+Rc), s		4.5		4.5		4.5		4.5				
Max Green Setting (Gmax), s		40.5		70.5		40.5		70.5				
Max Q Clear Time (g_c+I1), s		7.2		3.3		5.0		9.4				
Green Ext Time (p_c), s		2.1		0.8		1.3		1.2				
Intersection Summary												
HCM 7th Control Delay, s/veh			8.3									
HCM 7th LOS			A									
Notes												
Unsignalized Delay for [NBR] is excluded from calculations of the approach delay and intersection delay.												

HCM 7th TWSC
8: Oldham Parkway & Access 3

Existing + Full Development Traffic Volumes
AM Peak Hour

Intersection												
Int Delay, s/veh	2.5											
Movement	EBL	EBT	EBR	WBL	WBT	WBR	NBL	NBT	NBR	SBL	SBT	SBR
Lane Configurations		+			+		↑	↓			+	
Traffic Vol, veh/h	8	0	32	39	0	2	37	178	47	3	132	11
Future Vol, veh/h	8	0	32	39	0	2	37	178	47	3	132	11
Conflicting Peds, #/hr	0	0	0	0	0	0	0	0	0	0	0	0
Sign Control	Stop	Stop	Stop	Stop	Stop	Stop	Free	Free	Free	Free	Free	Free
RT Channelized	-	-	None	-	-	None	-	-	None	-	-	None
Storage Length	-	-	-	-	-	-	150	-	-	-	-	-
Veh in Median Storage, #	-	0	-	-	0	-	-	0	-	-	0	-
Grade, %	-	0	-	-	0	-	-	0	-	-	0	-
Peak Hour Factor	98	98	98	98	98	98	98	98	98	98	98	98
Heavy Vehicles, %	2	2	2	2	2	2	2	2	2	2	2	2
Mvmt Flow	8	0	33	40	0	2	38	182	48	3	135	11

Major/Minor	Minor2		Minor1		Major1		Major2					
Conflicting Flow All	404	452	140	422	433	206	146	0	0	230	0	0
Stage 1	146	146	-	281	281	-	-	-	-	-	-	-
Stage 2	257	305	-	141	152	-	-	-	-	-	-	-
Critical Hdwy	7.12	6.52	6.22	7.12	6.52	6.22	4.12	-	-	4.12	-	-
Critical Hdwy Stg 1	6.12	5.52	-	6.12	5.52	-	-	-	-	-	-	-
Critical Hdwy Stg 2	6.12	5.52	-	6.12	5.52	-	-	-	-	-	-	-
Follow-up Hdwy	3.518	4.018	3.318	3.518	4.018	3.318	2.218	-	-	2.218	-	-
Pot Cap-1 Maneuver	557	503	908	542	516	835	1436	-	-	1338	-	-
Stage 1	856	776	-	726	678	-	-	-	-	-	-	-
Stage 2	747	662	-	862	772	-	-	-	-	-	-	-
Platoon blocked, %								-	-	-	-	-
Mov Cap-1 Maneuver	540	489	908	508	501	835	1436	-	-	1338	-	-
Mov Cap-2 Maneuver	540	489	-	508	501	-	-	-	-	-	-	-
Stage 1	854	774	-	707	660	-	-	-	-	-	-	-
Stage 2	726	645	-	829	770	-	-	-	-	-	-	-

Approach	EB		WB		NB		SB	
HCM Control Delay, s/v	9.75		12.57		1.07		0.16	
HCM LOS	A		B					

Minor Lane/Major Mvmt	NBL	NBT	NBR	EBLn1	WBLn1	SBL	SBT	SBR
Capacity (veh/h)	1436	-	-	799	517	36	-	-
HCM Lane V/C Ratio	0.026	-	-	0.051	0.081	0.002	-	-
HCM Control Delay (s/veh)	7.6	-	-	9.7	12.6	7.7	0	-
HCM Lane LOS	A	-	-	A	B	A	A	-
HCM 95th %tile Q(veh)	0.1	-	-	0.2	0.3	0	-	-

Intersection						
Int Delay, s/veh	0.4					
Movement	EBT	EBR	WBL	WBT	NBL	NBR
Lane Configurations	T			T	T	
Traffic Vol, veh/h	141	5	5	183	4	5
Future Vol, veh/h	141	5	5	183	4	5
Conflicting Peds, #/hr	0	0	0	0	0	0
Sign Control	Free	Free	Free	Free	Stop	Stop
RT Channelized	-	None	-	None	-	None
Storage Length	-	-	-	-	0	-
Veh in Median Storage, #	0	-	-	0	0	-
Grade, %	0	-	-	0	0	-
Peak Hour Factor	98	98	98	98	98	98
Heavy Vehicles, %	2	2	2	2	2	2
Mvmt Flow	144	5	5	187	4	5

Major/Minor	Major1	Major2	Minor1		
Conflicting Flow All	0	0	149	0	343
Stage 1	-	-	-	-	146
Stage 2	-	-	-	-	197
Critical Hdwy	-	-	4.12	-	6.42
Critical Hdwy Stg 1	-	-	-	-	5.42
Critical Hdwy Stg 2	-	-	-	-	5.42
Follow-up Hdwy	-	-	2.218	-	3.518
Pot Cap-1 Maneuver	-	-	1432	-	653
Stage 1	-	-	-	-	881
Stage 2	-	-	-	-	836
Platoon blocked, %	-	-	-	-	-
Mov Cap-1 Maneuver	-	-	1432	-	650
Mov Cap-2 Maneuver	-	-	-	-	650
Stage 1	-	-	-	-	881
Stage 2	-	-	-	-	833

Approach	EB	WB	NB
HCM Control Delay, s/v	0	0.2	9.74
HCM LOS			A

Minor Lane/Major Mvmt	NBLn1	EBT	EBR	WBL	WBT
Capacity (veh/h)	769	-	-	48	-
HCM Lane V/C Ratio	0.012	-	-	0.004	-
HCM Control Delay (s/veh)	9.7	-	-	7.5	0
HCM Lane LOS	A	-	-	A	A
HCM 95th %tile Q(veh)	0	-	-	0	-

Intersection						
Int Delay, s/veh	0.3					
Movement	EBT	EBR	WBL	WBT	NBL	NBR
Lane Configurations	T			T	T	
Traffic Vol, veh/h	142	5	5	182	4	4
Future Vol, veh/h	142	5	5	182	4	4
Conflicting Peds, #/hr	0	0	0	0	0	0
Sign Control	Free	Free	Free	Free	Stop	Stop
RT Channelized	-	None	-	None	-	None
Storage Length	-	-	-	-	0	-
Veh in Median Storage, #	0	-	-	0	0	-
Grade, %	0	-	-	0	0	-
Peak Hour Factor	98	98	98	98	98	98
Heavy Vehicles, %	2	2	2	2	2	2
Mvmt Flow	145	5	5	186	4	4

Major/Minor	Major1	Major2	Minor1		
Conflicting Flow All	0	0	150	0	343
Stage 1	-	-	-	-	147
Stage 2	-	-	-	-	196
Critical Hdwy	-	-	4.12	-	6.42
Critical Hdwy Stg 1	-	-	-	-	5.42
Critical Hdwy Stg 2	-	-	-	-	5.42
Follow-up Hdwy	-	-	2.218	-	3.518
Pot Cap-1 Maneuver	-	-	1431	-	653
Stage 1	-	-	-	-	880
Stage 2	-	-	-	-	837
Platoon blocked, %	-	-	-	-	-
Mov Cap-1 Maneuver	-	-	1431	-	650
Mov Cap-2 Maneuver	-	-	-	-	650
Stage 1	-	-	-	-	880
Stage 2	-	-	-	-	834

Approach	EB	WB	NB
HCM Control Delay, s/v	0	0.2	9.82
HCM LOS			A

Minor Lane/Major Mvmt	NBLn1	EBT	EBR	WBL	WBT
Capacity (veh/h)	755	-	-	48	-
HCM Lane V/C Ratio	0.011	-	-	0.004	-
HCM Control Delay (s/veh)	9.8	-	-	7.5	0
HCM Lane LOS	A	-	-	A	A
HCM 95th %tile Q(veh)	0	-	-	0	-

Intersection						
Int Delay, s/veh	4.2					
Movement	WBL	WBR	NBT	NBR	SBL	SBT
Lane Configurations	↘		↗		↘	↗
Traffic Vol, veh/h	179	21	174	19	19	315
Future Vol, veh/h	179	21	174	19	19	315
Conflicting Peds, #/hr	0	0	0	0	0	0
Sign Control	Stop	Stop	Free	Free	Free	Free
RT Channelized	-	None	-	None	-	None
Storage Length	0	-	-	-	100	-
Veh in Median Storage, #	0	-	0	-	-	0
Grade, %	0	-	0	-	-	0
Peak Hour Factor	98	98	98	98	98	98
Heavy Vehicles, %	2	2	2	2	2	2
Mvmt Flow	183	21	178	19	19	321

Major/Minor	Minor1	Major1	Major2		
Conflicting Flow All	547	187	0	0	197
Stage 1	187	-	-	-	-
Stage 2	360	-	-	-	-
Critical Hdwy	6.42	6.22	-	-	4.12
Critical Hdwy Stg 1	5.42	-	-	-	-
Critical Hdwy Stg 2	5.42	-	-	-	-
Follow-up Hdwy	3.518	3.318	-	-	2.218
Pot Cap-1 Maneuver	498	855	-	-	1376
Stage 1	845	-	-	-	-
Stage 2	706	-	-	-	-
Platoon blocked, %			-	-	-
Mov Cap-1 Maneuver	491	855	-	-	1376
Mov Cap-2 Maneuver	566	-	-	-	-
Stage 1	845	-	-	-	-
Stage 2	696	-	-	-	-

Approach	WB	NB	SB
HCM Control Delay, s/v	14.36	0	0.44
HCM LOS	B		

Minor Lane/Major Mvmt	NBT	NBRWBLn1	SBL	SBT
Capacity (veh/h)	-	-	587	1376
HCM Lane V/C Ratio	-	-	0.348	0.014
HCM Control Delay (s/veh)	-	-	14.4	7.7
HCM Lane LOS	-	-	B	A
HCM 95th %tile Q(veh)	-	-	1.5	0

Intersection						
Int Delay, s/veh	1.2					
Movement	WBL	WBR	NBT	NBR	SBL	SBT
Lane Configurations	↔		↔		↔	↔
Traffic Vol, veh/h	22	27	176	19	25	312
Future Vol, veh/h	22	27	176	19	25	312
Conflicting Peds, #/hr	0	0	0	0	0	0
Sign Control	Stop	Stop	Free	Free	Free	Free
RT Channelized	-	None	-	None	-	None
Storage Length	-	-	-	-	100	-
Veh in Median Storage, #	0	-	0	-	-	0
Grade, %	0	-	0	-	-	0
Peak Hour Factor	98	98	98	98	98	98
Heavy Vehicles, %	2	2	2	2	2	2
Mvmt Flow	22	28	180	19	26	318

Major/Minor	Minor1	Major1	Major2			
Conflicting Flow All	559	189	0	0	199	0
Stage 1	189	-	-	-	-	-
Stage 2	369	-	-	-	-	-
Critical Hdwy	6.42	6.22	-	-	4.12	-
Critical Hdwy Stg 1	5.42	-	-	-	-	-
Critical Hdwy Stg 2	5.42	-	-	-	-	-
Follow-up Hdwy	3.518	3.318	-	-	2.218	-
Pot Cap-1 Maneuver	490	853	-	-	1373	-
Stage 1	843	-	-	-	-	-
Stage 2	699	-	-	-	-	-
Platoon blocked, %			-	-		
Mov Cap-1 Maneuver	481	853	-	-	1373	-
Mov Cap-2 Maneuver	559	-	-	-	-	-
Stage 1	843	-	-	-	-	-
Stage 2	686	-	-	-	-	-

Approach	WB	NB	SB
HCM Control Delay, s/v10.63		0	0.57
HCM LOS	B		

Minor Lane/Major Mvmt	NBT	NBRWBLn1	SBL	SBT
Capacity (veh/h)	-	-	690	1373
HCM Lane V/C Ratio	-	-	0.073	0.019
HCM Control Delay (s/veh)	-	-	10.6	7.7
HCM Lane LOS	-	-	B	A
HCM 95th %tile Q(veh)	-	-	0.2	0.1

HCM 7th TWSC
13: Jefferson Street & Access 6

Existing + Full Development Traffic Volumes
AM Peak Hour

Intersection												
Int Delay, s/veh	4.2											
Movement	EBL	EBT	EBR	WBL	WBT	WBR	NBL	NBT	NBR	SBL	SBT	SBR
Lane Configurations		↕			↕		↕	↕		↕	↕	
Traffic Vol, veh/h	44	0	23	37	0	82	19	148	36	74	277	39
Future Vol, veh/h	44	0	23	37	0	82	19	148	36	74	277	39
Conflicting Peds, #/hr	0	0	0	0	0	0	0	0	0	0	0	0
Sign Control	Stop	Stop	Stop	Stop	Stop	Stop	Free	Free	Free	Free	Free	Free
RT Channelized	-	-	None	-	-	None	-	-	None	-	-	None
Storage Length	-	-	-	-	-	-	100	-	-	100	-	-
Veh in Median Storage, #	-	0	-	-	0	-	-	0	-	-	0	-
Grade, %	-	0	-	-	0	-	-	0	-	-	0	-
Peak Hour Factor	98	98	98	98	98	98	98	98	98	98	98	98
Heavy Vehicles, %	2	2	2	2	2	2	2	2	2	2	2	2
Mvmt Flow	45	0	23	38	0	84	19	151	37	76	283	40

Major/Minor	Minor2		Minor1		Major1		Major2					
Conflicting Flow All	643	680	303	642	682	169	322	0	0	188	0	0
Stage 1	454	454	-	208	208	-	-	-	-	-	-	-
Stage 2	190	227	-	434	473	-	-	-	-	-	-	-
Critical Hdwy	7.12	6.52	6.22	7.12	6.52	6.22	4.12	-	-	4.12	-	-
Critical Hdwy Stg 1	6.12	5.52	-	6.12	5.52	-	-	-	-	-	-	-
Critical Hdwy Stg 2	6.12	5.52	-	6.12	5.52	-	-	-	-	-	-	-
Follow-up Hdwy	3.518	4.018	3.318	3.518	4.018	3.318	2.218	-	-	2.218	-	-
Pot Cap-1 Maneuver	386	373	737	387	372	875	1237	-	-	1386	-	-
Stage 1	586	570	-	794	730	-	-	-	-	-	-	-
Stage 2	812	716	-	601	558	-	-	-	-	-	-	-
Platoon blocked, %								-	-	-	-	-
Mov Cap-1 Maneuver	325	347	737	349	347	875	1237	-	-	1386	-	-
Mov Cap-2 Maneuver	325	347	-	349	347	-	-	-	-	-	-	-
Stage 1	554	539	-	781	718	-	-	-	-	-	-	-
Stage 2	723	705	-	550	528	-	-	-	-	-	-	-

Approach	EB	WB	NB	SB
HCM Control Delay, s/v15.77		12.59	0.74	1.47
HCM LOS	C	B		

Minor Lane/Major Mvmt	NBL	NBT	NBR	EBLn1WBLn1	SBL	SBT	SBR
Capacity (veh/h)	1237	-	-	402	595	1386	-
HCM Lane V/C Ratio	0.016	-	-	0.17	0.204	0.054	-
HCM Control Delay (s/veh)	8	-	-	15.8	12.6	7.7	-
HCM Lane LOS	A	-	-	C	B	A	-
HCM 95th %tile Q(veh)	0	-	-	0.6	0.8	0.2	-

Intersection						
Int Delay, s/veh	1.5					
Movement	WBL	WBR	NBT	NBR	SBL	SBT
Lane Configurations	↘		↗		↘	↗
Traffic Vol, veh/h	27	26	250	24	65	363
Future Vol, veh/h	27	26	250	24	65	363
Conflicting Peds, #/hr	0	0	0	0	0	0
Sign Control	Stop	Stop	Free	Free	Free	Free
RT Channelized	-	None	-	None	-	None
Storage Length	0	-	-	-	100	-
Veh in Median Storage, #	0	-	0	-	-	0
Grade, %	0	-	0	-	-	0
Peak Hour Factor	98	98	98	98	98	98
Heavy Vehicles, %	2	2	2	2	2	2
Mvmt Flow	28	27	255	24	66	370

Major/Minor	Minor1	Major1	Major2		
Conflicting Flow All	770	267	0	0	280
Stage 1	267	-	-	-	-
Stage 2	503	-	-	-	-
Critical Hdwy	6.42	6.22	-	-	4.12
Critical Hdwy Stg 1	5.42	-	-	-	-
Critical Hdwy Stg 2	5.42	-	-	-	-
Follow-up Hdwy	3.518	3.318	-	-	2.218
Pot Cap-1 Maneuver	369	771	-	-	1283
Stage 1	777	-	-	-	-
Stage 2	607	-	-	-	-
Platoon blocked, %			-	-	-
Mov Cap-1 Maneuver	350	771	-	-	1283
Mov Cap-2 Maneuver	454	-	-	-	-
Stage 1	777	-	-	-	-
Stage 2	576	-	-	-	-

Approach	WB	NB	SB
HCM Control Delay, s/v11.99		0	1.21
HCM LOS	B		

Minor Lane/Major Mvmt	NBT	NBRWBLn1	SBL	SBT
Capacity (veh/h)	-	-	569	1283
HCM Lane V/C Ratio	-	-	0.095	0.052
HCM Control Delay (s/veh)	-	-	12	8
HCM Lane LOS	-	-	B	A
HCM 95th %tile Q(veh)	-	-	0.3	0.2

HCM Unsignalized Intersection Capacity Analysis Existing + Full Development Traffic Volumes
 15: Access 8 & Oldham Parkway AM Peak Hour



Movement	EBT	EBR	WBL	WBT	NBL	NBR	
Lane Configurations	↑↑↑↑			↑↑		↗	
Traffic Volume (veh/h)	808	10	0	1119	0	55	
Future Volume (Veh/h)	808	10	0	1119	0	55	
Sign Control	Free			Free	Stop		
Grade	0%			0%	0%		
Peak Hour Factor	0.98	0.98	0.98	0.98	0.98	0.98	
Hourly flow rate (vph)	824	10	0	1142	0	56	
Pedestrians							
Lane Width (ft)							
Walking Speed (ft/s)							
Percent Blockage							
Right turn flare (veh)							
Median type	None			None			
Median storage (veh)							
Upstream signal (ft)	1111			281			
pX, platoon unblocked							
vC, conflicting volume			834	1400	211		
vC1, stage 1 conf vol							
vC2, stage 2 conf vol							
vCu, unblocked vol			834	1400	211		
tC, single (s)			4.1	6.8	6.9		
tC, 2 stage (s)							
tF (s)			2.2	3.5	3.3		
p0 queue free %			100	100	93		
cM capacity (veh/h)			795	131	794		
Direction, Lane #	EB 1	EB 2	EB 3	EB 4	WB 1	WB 2	NB 1
Volume Total	235	235	235	128	571	571	56
Volume Left	0	0	0	0	0	0	0
Volume Right	0	0	0	10	0	0	56
cSH	1700	1700	1700	1700	1700	1700	794
Volume to Capacity	0.14	0.14	0.14	0.08	0.34	0.34	0.07
Queue Length 95th (ft)	0	0	0	0	0	0	6
Control Delay (s/veh)	0.0	0.0	0.0	0.0	0.0	0.0	9.9
Lane LOS							A
Approach Delay (s/veh)	0.0			0.0			9.9
Approach LOS							A
Intersection Summary							
Average Delay			0.3				
Intersection Capacity Utilization			34.3%	ICU Level of Service		A	
Analysis Period (min)			15				

Queues
1: Ward Road & Oldham Parkway

Existing + Full Development Traffic Volumes
PM Peak Hour



Lane Group	EBL	EBT	WBT	NBL	NBT	SBL	SBT	SBR
Lane Group Flow (vph)	136	70	217	30	575	157	569	186
v/c Ratio	0.55	0.16	0.49	0.15	0.55	0.48	0.31	0.20
Control Delay (s/veh)	33.0	13.0	18.2	34.0	22.4	31.8	12.5	3.4
Queue Delay	0.0	0.0	0.0	0.0	0.0	0.0	0.0	0.0
Total Delay (s/veh)	33.0	13.0	18.2	34.0	22.4	31.8	12.5	3.4
Queue Length 50th (ft)	46	9	41	11	94	54	51	0
Queue Length 95th (ft)	120	43	121	42	189	138	156	38
Internal Link Dist (ft)		116	246		459		353	
Turn Bay Length (ft)				110		105		
Base Capacity (vph)	620	1017	973	472	2488	675	2824	1301
Starvation Cap Reductn	0	0	0	0	0	0	0	0
Spillback Cap Reductn	0	0	0	0	0	0	0	0
Storage Cap Reductn	0	0	0	0	0	0	0	0
Reduced v/c Ratio	0.22	0.07	0.22	0.06	0.23	0.23	0.20	0.14
Intersection Summary								

HCM 7th Signalized Intersection Summary
1: Ward Road & Oldham Parkway

Existing + Full Development Traffic Volumes
PM Peak Hour



Movement	EBL	EBT	EBR	WBL	WBT	WBR	NBL	NBT	NBR	SBL	SBT	SBR
Lane Configurations												
Traffic Volume (veh/h)	133	29	39	31	38	143	29	529	34	154	558	182
Future Volume (veh/h)	133	29	39	31	38	143	29	529	34	154	558	182
Initial Q (Qb), veh	0	0	0	0	0	0	0	0	0	0	0	0
Lane Width Adj.	1.00	1.00	1.00	1.00	1.00	1.00	1.00	1.00	1.00	1.00	1.00	1.00
Ped-Bike Adj(A_pbT)			1.00	1.00		1.00	1.00		1.00	1.00		1.00
Parking Bus, Adj	1.00	1.00	1.00	1.00	1.00	1.00	1.00	1.00	1.00	1.00	1.00	1.00
Work Zone On Approach		No			No			No			No	
Adj Sat Flow, veh/h/ln	1870	1870	1870	1870	1870	1870	1870	1870	1870	1870	1870	1870
Adj Flow Rate, veh/h	136	30	40	32	39	146	30	540	35	157	569	186
Peak Hour Factor	0.98	0.98	0.98	0.98	0.98	0.98	0.98	0.98	0.98	0.98	0.98	0.98
Percent Heavy Veh, %	2	2	2	2	2	2	2	2	2	2	2	2
Cap, veh/h	376	139	186	113	74	209	61	1116	72	210	1467	654
Arrive On Green	0.19	0.19	0.19	0.19	0.19	0.19	0.03	0.33	0.33	0.12	0.41	0.41
Sat Flow, veh/h	1199	727	969	143	386	1088	1781	3389	219	1781	3554	1585
Grp Volume(v), veh/h	136	0	70	217	0	0	30	283	292	157	569	186
Grp Sat Flow(s),veh/h/ln	1199	0	1696	1617	0	0	1781	1777	1831	1781	1777	1585
Q Serve(g_s), s	0.0	0.0	1.7	2.4	0.0	0.0	0.8	6.1	6.2	4.1	5.4	3.8
Cycle Q Clear(g_c), s	5.1	0.0	1.7	6.0	0.0	0.0	0.8	6.1	6.2	4.1	5.4	3.8
Prop In Lane	1.00		0.57	0.15		0.67	1.00		0.12	1.00		1.00
Lane Grp Cap(c), veh/h	376	0	325	395	0	0	61	585	603	210	1467	654
V/C Ratio(X)	0.36	0.00	0.22	0.55	0.00	0.00	0.49	0.48	0.48	0.75	0.39	0.28
Avail Cap(c_a), veh/h	1035	0	1257	1265	0	0	599	1588	1636	857	3689	1646
HCM Platoon Ratio	1.00	1.00	1.00	1.00	1.00	1.00	1.00	1.00	1.00	1.00	1.00	1.00
Upstream Filter(I)	1.00	0.00	1.00	1.00	0.00	0.00	1.00	1.00	1.00	1.00	1.00	1.00
Uniform Delay (d), s/veh	17.9	0.0	16.5	18.2	0.0	0.0	23.0	13.0	13.0	20.7	9.9	9.5
Incr Delay (d2), s/veh	0.6	0.0	0.3	1.2	0.0	0.0	6.0	0.9	0.9	5.3	0.2	0.3
Initial Q Delay(d3), s/veh	0.0	0.0	0.0	0.0	0.0	0.0	0.0	0.0	0.0	0.0	0.0	0.0
%ile BackOfQ(95%),veh/ln	2.4	0.0	1.1	3.7	0.0	0.0	0.7	3.8	4.0	3.3	3.0	1.9
Unsig. Movement Delay, s/veh												
LnGrp Delay(d), s/veh	18.5	0.0	16.8	19.4	0.0	0.0	29.0	13.8	13.8	26.0	10.2	9.8
LnGrp LOS	B		B	B			C	B	B	C	B	A
Approach Vol, veh/h		206			217			605			912	
Approach Delay, s/veh		17.9			19.4			14.6			12.8	
Approach LOS		B			B			B			B	
Timer - Assigned Phs	1	2		4	5	6		8				
Phs Duration (G+Y+Rc), s	7.4	25.7		15.4	11.4	21.7		15.4				
Change Period (Y+Rc), s	5.7	5.7		6.1	5.7	5.7		6.1				
Max Green Setting (Gmax), s	16.3	50.3		35.9	23.3	43.3		35.9				
Max Q Clear Time (g_c+I1), s	2.8	7.4		8.0	6.1	8.2		7.1				
Green Ext Time (p_c), s	0.0	7.4		1.3	0.4	5.4		0.9				
Intersection Summary												
HCM 7th Control Delay, s/veh			14.6									
HCM 7th LOS			B									
Notes												
User approved pedestrian interval to be less than phase max green.												

HCM 7th TWSC
2: Jefferson Street & Oldham Parkway

Existing + Full Development Traffic Volumes
PM Peak Hour

Intersection												
Int Delay, s/veh	3.1											
Movement	EBL	EBT	EBR	WBL	WBT	WBR	NBL	NBT	NBR	SBL	SBT	SBR
Lane Configurations	↖	↖↗		↖	↖↗				↖			↖
Traffic Vol, veh/h	2	549	28	246	302	278	0	0	207	0	0	2
Future Vol, veh/h	2	549	28	246	302	278	0	0	207	0	0	2
Conflicting Peds, #/hr	0	0	0	0	0	0	0	0	0	0	0	0
Sign Control	Free	Free	Free	Free	Free	Free	Stop	Stop	Stop	Stop	Stop	Stop
RT Channelized	-	-	None	-	-	None	-	-	None	-	-	None
Storage Length	150	-	-	200	-	-	-	-	0	-	-	0
Veh in Median Storage, #	-	0	-	-	0	-	-	0	-	-	0	-
Grade, %	-	0	-	-	0	-	-	0	-	-	0	-
Peak Hour Factor	98	98	98	98	98	98	98	98	98	98	98	98
Heavy Vehicles, %	2	2	2	2	2	2	2	2	2	2	2	2
Mvmt Flow	2	560	29	251	308	284	0	0	211	0	0	2

Major/Minor	Major1		Major2		Minor1		Minor2					
Conflicting Flow All	592	0	0	589	0	0	-	-	294	-	-	296
Stage 1	-	-	-	-	-	-	-	-	-	-	-	-
Stage 2	-	-	-	-	-	-	-	-	-	-	-	-
Critical Hdwy	4.14	-	-	4.14	-	-	-	-	6.94	-	-	6.94
Critical Hdwy Stg 1	-	-	-	-	-	-	-	-	-	-	-	-
Critical Hdwy Stg 2	-	-	-	-	-	-	-	-	-	-	-	-
Follow-up Hdwy	2.22	-	-	2.22	-	-	-	-	3.32	-	-	3.32
Pot Cap-1 Maneuver	980	-	-	983	-	-	0	0	702	0	0	700
Stage 1	-	-	-	-	-	-	0	0	-	0	0	-
Stage 2	-	-	-	-	-	-	0	0	-	0	0	-
Platoon blocked, %		-	-	-	-	-						
Mov Cap-1 Maneuver	980	-	-	983	-	-	-	-	702	-	-	700
Mov Cap-2 Maneuver	-	-	-	-	-	-	-	-	-	-	-	-
Stage 1	-	-	-	-	-	-	-	-	-	-	-	-
Stage 2	-	-	-	-	-	-	-	-	-	-	-	-

Approach	EB		WB		NB		SB	
HCM Control Delay, s/v	0.03		2.95		12.32		10.16	
HCM LOS					B		B	

Minor Lane/Major Mvmt	NBLn1	EBL	EBT	EBR	WBL	WBT	WBR	SBLn1
Capacity (veh/h)	702	980	-	-	983	-	-	700
HCM Lane V/C Ratio	0.301	0.002	-	-	0.255	-	-	0.003
HCM Control Delay (s/veh)	12.3	8.7	-	-	9.9	-	-	10.2
HCM Lane LOS	B	A	-	-	A	-	-	B
HCM 95th %tile Q(veh)	1.3	0	-	-	1	-	-	0

Queues
3: M-291 & Oldham Parkway

Existing + Full Development Traffic Volumes
PM Peak Hour



























Lane Group	EBL	EBR	NBL	NBT	SBT	SBR
Lane Group Flow (vph)	542	256	260	1512	1794	548
v/c Ratio	0.84	0.44	0.70	0.42	0.66	0.54
Control Delay (s/veh)	60.2	3.1	53.1	1.1	22.3	9.0
Queue Delay	0.0	0.0	0.0	0.0	0.0	0.0
Total Delay (s/veh)	60.2	3.1	53.1	1.1	22.3	9.0
Queue Length 50th (ft)	207	0	107	6	371	95
Queue Length 95th (ft)	272	9	m141	m7	426	196
Internal Link Dist (ft)				1398	887	
Turn Bay Length (ft)	345		250			180
Base Capacity (vph)	680	608	394	3555	2698	1000
Starvation Cap Reductn	0	0	0	0	0	0
Spillback Cap Reductn	0	0	0	0	0	0
Storage Cap Reductn	0	0	0	0	0	0
Reduced v/c Ratio	0.80	0.42	0.66	0.43	0.66	0.55

Intersection Summary

m Volume for 95th percentile queue is metered by upstream signal.

HCM 7th Signalized Intersection Summary
3: M-291 & Oldham Parkway

Existing + Full Development Traffic Volumes
PM Peak Hour

												
Movement	EBL	EBT	EBR	WBL	WBT	WBR	NBL	NBT	NBR	SBL	SBT	SBR
Lane Configurations												
Traffic Volume (veh/h)	531	0	251	0	0	0	255	1482	0	0	1758	537
Future Volume (veh/h)	531	0	251	0	0	0	255	1482	0	0	1758	537
Initial Q (Qb), veh	0	0	0	0	0	0	0	0	0	0	0	0
Lane Width Adj.	1.00	1.00	1.00	1.00	1.00	1.00	1.00	1.00	1.00	1.00	1.00	1.00
Ped-Bike Adj(A_pbT)	1.00		1.00	1.00		1.00	1.00		1.00	1.00		1.00
Parking Bus, Adj	1.00	1.00	1.00	1.00	1.00	1.00	1.00	1.00	1.00	1.00	1.00	1.00
Work Zone On Approach		No			No			No			No	
Adj Sat Flow, veh/h/ln	1870	1870	1870	1870	1870	1870	1870	1870	1870	1870	1870	1870
Adj Flow Rate, veh/h	542	0	0	0	0	0	260	1512	0	0	1794	0
Peak Hour Factor	0.98	0.98	0.98	0.98	0.98	0.98	0.98	0.98	0.98	0.98	0.98	0.98
Percent Heavy Veh, %	2	2	2	2	2	2	2	2	2	2	2	2
Cap, veh/h	609	333		3	2	1	892	3593		3	1994	
Arrive On Green	0.18	0.00	0.00	0.00	0.00	0.00	0.52	1.00	0.00	0.00	0.39	0.00
Sat Flow, veh/h	3456	1870	1585	3456	1870	1585	3456	5106	1585	3456	5106	1585
Grp Volume(v), veh/h	542	0	0	0	0	0	260	1512	0	0	1794	0
Grp Sat Flow(s),veh/h/ln	1728	1870	1585	1728	1870	1585	1728	1702	1585	1728	1702	1585
Q Serve(g_s), s	18.4	0.0	0.0	0.0	0.0	0.0	5.1	0.0	0.0	0.0	39.6	0.0
Cycle Q Clear(g_c), s	18.4	0.0	0.0	0.0	0.0	0.0	5.1	0.0	0.0	0.0	39.6	0.0
Prop In Lane	1.00		1.00	1.00		1.00	1.00		1.00	1.00		1.00
Lane Grp Cap(c), veh/h	609	333		3	2	1	892	3593		3	1994	
V/C Ratio(X)	0.89	0.00		0.00	0.00	0.00	0.29	0.42		0.00	0.90	
Avail Cap(c_a), veh/h	685	397		144	109	92	892	3593		144	2025	
HCM Platoon Ratio	1.00	1.00	1.00	1.00	1.00	1.00	2.00	2.00	2.00	1.00	1.00	1.00
Upstream Filter(I)	1.00	0.00	0.00	0.00	0.00	0.00	0.76	0.76	0.00	0.00	1.00	0.00
Uniform Delay (d), s/veh	48.3	0.0	0.0	0.0	0.0	0.0	22.8	0.0	0.0	0.0	34.4	0.0
Incr Delay (d2), s/veh	12.8	0.0	0.0	0.0	0.0	0.0	0.1	0.3	0.0	0.0	7.0	0.0
Initial Q Delay(d3), s/veh	0.0	0.0	0.0	0.0	0.0	0.0	0.0	0.0	0.0	0.0	0.0	0.0
%ile BackOfQ(95%),veh/ln	14.0	0.0	0.0	0.0	0.0	0.0	3.4	0.2	0.0	0.0	23.5	0.0
Unsig. Movement Delay, s/veh												
LnGrp Delay(d), s/veh	61.1	0.0	0.0	0.0	0.0	0.0	22.9	0.3	0.0	0.0	41.4	0.0
LnGrp LOS	E						C	A			D	
Approach Vol, veh/h		542			0			1772			1794	
Approach Delay, s/veh		61.1			0.0			3.6			41.4	
Approach LOS		E						A			D	
Timer - Assigned Phs	1	2	3	4	5	6	7	8				
Phs Duration (G+Y+Rc), s	0.0	91.7	0.0	28.3	38.2	53.5	28.3	0.0				
Change Period (Y+Rc), s	6.7	* 7.2	7.3	7.0	7.2	6.6	7.2	* 7				
Max Green Setting (Gmax), s	5.0	* 57	5.0	25.5	13.8	47.6	23.8	* 7				
Max Q Clear Time (g_c+I1), s	0.0	2.0	0.0	0.0	7.1	41.6	20.4	0.0				
Green Ext Time (p_c), s	0.0	22.8	0.0	0.0	0.5	5.2	0.8	0.0				
Intersection Summary												
HCM 7th Control Delay, s/veh				27.7								
HCM 7th LOS				C								
Notes												
User approved pedestrian interval to be less than phase max green.												
* HCM 7th computational engine requires equal clearance times for the phases crossing the barrier.												

Unsignalized Delay for [NBR, EBR, SBR] is excluded from calculations of the approach delay and intersection delay.

Queues
4: Jefferson Street & Persels Road

Existing + Full Development Traffic Volumes
PM Peak Hour



Lane Group	EBL	EBT	WBL	WBT	NBL	NBT	SBL	SBT
Lane Group Flow (vph)	53	273	172	344	18	237	181	126
v/c Ratio	0.10	0.18	0.23	0.37	0.05	0.66	0.57	0.25
Control Delay (s/veh)	14.0	24.5	13.5	24.6	26.3	28.1	37.4	24.3
Queue Delay	0.0	0.0	0.0	0.0	0.0	0.0	0.0	0.0
Total Delay (s/veh)	14.0	24.5	13.5	24.6	26.3	28.1	37.4	24.3
Queue Length 50th (ft)	15	64	54	182	10	68	109	47
Queue Length 95th (ft)	41	123	m101	m319	24	147	147	101
Internal Link Dist (ft)		1272		101		1173		315
Turn Bay Length (ft)	110		175		110		150	
Base Capacity (vph)	485	1520	736	913	328	557	323	561
Starvation Cap Reductn	0	0	0	0	0	0	0	0
Spillback Cap Reductn	0	0	0	0	0	0	0	0
Storage Cap Reductn	0	0	0	0	0	0	0	0
Reduced v/c Ratio	0.11	0.18	0.23	0.38	0.05	0.43	0.56	0.22

Intersection Summary

m Volume for 95th percentile queue is metered by upstream signal.

HCM 7th Signalized Intersection Summary
4: Jefferson Street & Persels Road













Existing + Full Development Traffic Volumes
PM Peak Hour



Movement	EBL	EBT	EBR	WBL	WBT	WBR	NBL	NBT	NBR	SBL	SBT	SBR
Lane Configurations	↗	↗↘		↗	↘		↗	↘		↗	↘	
Traffic Volume (veh/h)	52	252	16	169	280	57	18	52	180	177	62	62
Future Volume (veh/h)	52	252	16	169	280	57	18	52	180	177	62	62
Initial Q (Qb), veh	0	0	0	0	0	0	0	0	0	0	0	0
Lane Width Adj.	1.00	1.00	1.00	1.00	1.00	1.00	1.00	1.00	1.00	1.00	1.00	1.00
Ped-Bike Adj(A_pbT)	1.00		1.00	1.00		1.00	1.00		1.00	1.00		1.00
Parking Bus, Adj	1.00	1.00	1.00	1.00	1.00	1.00	1.00	1.00	1.00	1.00	1.00	1.00
Work Zone On Approach		No			No			No			No	
Adj Sat Flow, veh/h/ln	1870	1870	1870	1870	1870	1870	1870	1870	1870	1870	1870	1870
Adj Flow Rate, veh/h	53	257	16	172	286	58	18	53	184	181	63	63
Peak Hour Factor	0.98	0.98	0.98	0.98	0.98	0.98	0.98	0.98	0.98	0.98	0.98	0.98
Percent Heavy Veh, %	2	2	2	2	2	2	2	2	2	2	2	2
Cap, veh/h	662	425	26	879	338	69	346	64	220	273	201	201
Arrive On Green	0.34	0.13	0.13	0.58	0.30	0.30	0.04	0.17	0.17	0.10	0.23	0.23
Sat Flow, veh/h	1781	3399	210	1781	1509	306	1781	367	1274	1781	858	858
Grp Volume(v), veh/h	53	134	139	172	0	344	18	0	237	181	0	126
Grp Sat Flow(s),veh/h/ln	1781	1777	1832	1781	0	1815	1781	0	1641	1781	0	1716
Q Serve(g_s), s	0.0	8.5	8.6	0.0	0.0	21.3	1.0	0.0	16.8	9.7	0.0	7.3
Cycle Q Clear(g_c), s	0.0	8.5	8.6	0.0	0.0	21.3	1.0	0.0	16.8	9.7	0.0	7.3
Prop In Lane	1.00		0.11	1.00		0.17	1.00		0.78	1.00		0.50
Lane Grp Cap(c), veh/h	662	222	229	879	0	407	346	0	284	273	0	401
V/C Ratio(X)	0.08	0.60	0.61	0.20	0.00	0.84	0.05	0.00	0.83	0.66	0.00	0.31
Avail Cap(c_a), veh/h	662	607	626	879	0	650	427	0	451	306	0	529
HCM Platoon Ratio	1.00	1.00	1.00	1.33	1.33	1.33	1.00	1.00	1.00	1.00	1.00	1.00
Upstream Filter(I)	1.00	1.00	1.00	1.00	0.00	1.00	1.00	0.00	1.00	1.00	0.00	1.00
Uniform Delay (d), s/veh	26.3	49.7	49.7	13.6	0.0	40.1	37.8	0.0	48.0	35.6	0.0	38.0
Incr Delay (d2), s/veh	0.1	11.5	11.5	0.2	0.0	18.9	0.1	0.0	13.3	5.4	0.0	0.9
Initial Q Delay(d3), s/veh	0.0	0.0	0.0	0.0	0.0	0.0	0.0	0.0	0.0	0.0	0.0	0.0
%ile BackOfQ(95%),veh/ln	1.8	7.9	8.2	3.7	0.0	16.4	0.8	0.0	12.4	8.1	0.0	5.7
Unsig. Movement Delay, s/veh												
LnGrp Delay(d), s/veh	26.4	61.2	61.2	13.8	0.0	59.1	37.9	0.0	61.2	41.0	0.0	39.0
LnGrp LOS	C	E	E	B		E	D		E	D		D
Approach Vol, veh/h		326			516			255			307	
Approach Delay, s/veh		55.5			44.0			59.6			40.2	
Approach LOS		E			D			E			D	
Timer - Assigned Phs	1	2	3	4	5	6	7	8				
Phs Duration (G+Y+Rc), s	57.4	20.0	16.8	25.8	45.5	31.9	9.5	33.1				
Change Period (Y+Rc), s	5.0	5.0	5.0	5.0	5.0	5.0	5.0	5.0				
Max Green Setting (Gmax), s	12.0	41.0	14.0	33.0	10.0	43.0	10.0	37.0				
Max Q Clear Time (g_c+I1), s	2.0	10.6	11.7	18.8	2.0	23.3	3.0	9.3				
Green Ext Time (p_c), s	0.5	3.0	0.2	2.0	0.1	3.6	0.0	1.3				
Intersection Summary												
HCM 7th Control Delay, s/veh				48.7								
HCM 7th LOS				D								

Queues
5: M-291 & Persels Road/Bailey Road

Existing + Full Development Traffic Volumes
PM Peak Hour

























												
Lane Group	EBL	EBT	EBR	WBL	WBT	WBR	NBL	NBT	NBR	SBL	SBT	SBR
Lane Group Flow (vph)	424	147	142	335	157	98	158	1278	273	50	1682	412
v/c Ratio	1.03	0.71	0.39	0.88	0.83	0.28	0.82	0.49	0.29	0.39	1.05	0.47
Control Delay (s/veh)	97.0	63.1	7.8	77.7	85.6	2.0	84.3	20.9	2.8	42.4	53.2	2.0
Queue Delay	0.0	0.0	0.0	0.0	0.0	0.0	0.0	0.0	0.0	0.0	0.0	0.0
Total Delay (s/veh)	97.0	63.1	7.8	77.7	85.6	2.0	84.3	20.9	2.8	42.4	53.2	2.0
Queue Length 50th (ft)	~189	93	5	135	121	0	121	242	0	38	~757	9
Queue Length 95th (ft)	#273	179	29	#236	#234	0	#233	284	44	m59	#900	18
Internal Link Dist (ft)		341			1421			2289			1398	
Turn Bay Length (ft)	200		150	280		290	310		350	330		
Base Capacity (vph)	410	232	376	379	195	350	199	2593	941	130	1598	867
Starvation Cap Reductn	0	0	0	0	0	0	0	0	0	0	0	0
Spillback Cap Reductn	0	0	0	0	0	0	0	0	0	0	0	0
Storage Cap Reductn	0	0	0	0	0	0	0	0	0	0	0	0
Reduced v/c Ratio	1.03	0.63	0.38	0.88	0.81	0.28	0.79	0.49	0.29	0.38	1.05	0.48

Intersection Summary

- ~ Volume exceeds capacity, queue is theoretically infinite.
Queue shown is maximum after two cycles.
- # 95th percentile volume exceeds capacity, queue may be longer.
Queue shown is maximum after two cycles.
- m Volume for 95th percentile queue is metered by upstream signal.

HCM 7th Signalized Intersection Summary
5: M-291 & Persels Road/Bailey Road

Existing + Full Development Traffic Volumes
PM Peak Hour

												
Movement	EBL	EBT	EBR	WBL	WBT	WBR	NBL	NBT	NBR	SBL	SBT	SBR
Lane Configurations												
Traffic Volume (veh/h)	416	144	139	328	154	96	155	1252	268	49	1648	404
Future Volume (veh/h)	416	144	139	328	154	96	155	1252	268	49	1648	404
Initial Q (Qb), veh	0	0	0	0	0	0	0	0	0	0	0	0
Lane Width Adj.	1.00	1.00	1.00	1.00	1.00	1.00	1.00	1.00	1.00	1.00	1.00	1.00
Ped-Bike Adj(A_pbT)	1.00		1.00	1.00		1.00	1.00		1.00	1.00		1.00
Parking Bus, Adj	1.00	1.00	1.00	1.00	1.00	1.00	1.00	1.00	1.00	1.00	1.00	1.00
Work Zone On Approach		No			No			No			No	
Adj Sat Flow, veh/h/ln	1870	1870	1856	1870	1870	1870	1870	1870	1870	1870	1870	1870
Adj Flow Rate, veh/h	424	147	142	335	157	98	158	1278	0	50	1682	0
Peak Hour Factor	0.98	0.98	0.98	0.98	0.98	0.98	0.98	0.98	0.98	0.98	0.98	0.98
Percent Heavy Veh, %	2	2	3	2	2	2	2	2	2	2	2	2
Cap, veh/h	403	184	154	412	187	158	185	2041		287	1637	
Arrive On Green	0.04	0.03	0.03	0.12	0.10	0.10	0.10	0.40	0.00	0.21	0.61	0.00
Sat Flow, veh/h	3456	1870	1572	3456	1870	1585	1781	5106	1585	1781	3554	1585
Grp Volume(v), veh/h	424	147	142	335	157	98	158	1278	0	50	1682	0
Grp Sat Flow(s),veh/h/ln	1728	1870	1572	1728	1870	1585	1781	1702	1585	1781	1777	1585
Q Serve(g_s), s	14.0	9.4	8.3	11.3	9.9	7.1	10.5	24.0	0.0	2.7	55.3	0.0
Cycle Q Clear(g_c), s	14.0	9.4	8.3	11.3	9.9	7.1	10.5	24.0	0.0	2.7	55.3	0.0
Prop In Lane	1.00		1.00	1.00		1.00	1.00		1.00	1.00		1.00
Lane Grp Cap(c), veh/h	403	184	154	412	187	158	185	2041		287	1637	
V/C Ratio(X)	1.05	0.80	0.92	0.81	0.84	0.62	0.86	0.63		0.17	1.03	
Avail Cap(c_a), veh/h	403	234	197	412	196	166	200	2481		287	1637	
HCM Platoon Ratio	0.33	0.33	0.33	1.00	1.00	1.00	1.00	1.00	1.00	1.33	1.33	1.33
Upstream Filter(I)	1.00	1.00	1.00	1.00	1.00	1.00	1.00	1.00	0.00	0.73	0.73	0.00
Uniform Delay (d), s/veh	57.7	56.9	33.6	51.6	53.1	51.8	52.9	28.8	0.0	40.6	23.2	0.0
Incr Delay (d2), s/veh	59.0	14.2	37.1	11.8	25.7	6.3	27.2	1.5	0.0	0.2	26.4	0.0
Initial Q Delay(d3), s/veh	0.0	0.0	0.0	0.0	0.0	0.0	0.0	0.0	0.0	0.0	0.0	0.0
%ile BackOfQ(95%),veh/ln	15.3	9.2	8.6	9.4	9.9	5.6	10.0	14.7	0.0	2.1	30.7	0.0
Unsig. Movement Delay, s/veh												
LnGrp Delay(d), s/veh	116.7	71.1	70.8	63.4	78.8	58.2	80.1	30.3	0.0	40.8	49.7	0.0
LnGrp LOS	F	E	E	E	E	E	F	C		D	F	
Approach Vol, veh/h		713			590			1436			1732	
Approach Delay, s/veh		98.2			66.6			35.8			49.4	
Approach LOS		F			E			D			D	
Timer - Assigned Phs	1	2	3	4	5	6	7	8				
Phs Duration (G+Y+Rc), s	25.4	54.5	21.4	18.8	18.5	61.3	21.1	19.1				
Change Period (Y+Rc), s	6.0	6.5	7.1	7.0	6.1	6.0	7.1	* 7.1				
Max Green Setting (Gmax), s	8.5	58.3	11.6	15.0	13.5	53.7	14.0	* 13				
Max Q Clear Time (g_c+I1), s	4.7	26.0	13.3	11.4	12.5	57.3	16.0	11.9				
Green Ext Time (p_c), s	0.0	21.9	0.0	0.4	0.0	0.0	0.0	0.1				
Intersection Summary												
HCM 7th Control Delay, s/veh			55.1									
HCM 7th LOS			E									
Notes												
User approved pedestrian interval to be less than phase max green.												
* HCM 7th computational engine requires equal clearance times for the phases crossing the barrier.												

Unsignalized Delay for [NBR, SBR] is excluded from calculations of the approach delay and intersection delay.

Intersection						
Int Delay, s/veh	0.2					
Movement	EBL	EBR	NBL	NBT	SBT	SBR
Lane Configurations		↗		↕	↕	
Traffic Vol, veh/h	0	18	0	304	561	0
Future Vol, veh/h	0	18	0	304	561	0
Conflicting Peds, #/hr	0	0	0	0	0	0
Sign Control	Stop	Stop	Free	Free	Free	Free
RT Channelized	-	None	-	None	-	None
Storage Length	-	0	-	-	-	-
Veh in Median Storage, #	0	-	-	0	0	-
Grade, %	0	-	-	0	0	-
Peak Hour Factor	98	98	98	98	98	98
Heavy Vehicles, %	2	2	2	2	2	2
Mvmt Flow	0	18	0	310	572	0

Major/Minor	Minor2	Major1	Major2		
Conflicting Flow All	-	572	-	0	-
Stage 1	-	-	-	-	-
Stage 2	-	-	-	-	-
Critical Hdwy	-	6.23	-	-	-
Critical Hdwy Stg 1	-	-	-	-	-
Critical Hdwy Stg 2	-	-	-	-	-
Follow-up Hdwy	-	3.319	-	-	-
Pot Cap-1 Maneuver	0	518	0	-	-
Stage 1	0	-	0	-	-
Stage 2	0	-	0	-	-
Platoon blocked, %				-	-
Mov Cap-1 Maneuver	-	518	-	-	-
Mov Cap-2 Maneuver	-	-	-	-	-
Stage 1	-	-	-	-	-
Stage 2	-	-	-	-	-

Approach	EB	NB	SB
HCM Control Delay, s/v	12.2	0	0
HCM LOS	B		

Minor Lane/Major Mvmt	NBT EBLn1	SBT
Capacity (veh/h)	- 518	-
HCM Lane V/C Ratio	- 0.035	-
HCM Control Delay (s/veh)	- 12.2	-
HCM Lane LOS	- B	-
HCM 95th %tile Q(veh)	- 0.1	-

Queues
7: Oldham Parkway & Access 2























Existing + Full Development Traffic Volumes
PM Peak Hour



Lane Group	EBL	EBT	WBL	WBT	NBL	NBT	NBR	SBL	SBT
Lane Group Flow (vph)	14	93	296	23	99	184	28	4	219
v/c Ratio	0.02	0.12	0.54	0.02	0.27	0.31	0.05	0.01	0.38
Control Delay (s/veh)	6.1	3.1	11.8	5.7	12.9	12.2	5.5	10.2	12.7
Queue Delay	0.0	0.0	0.0	0.0	0.0	0.0	0.0	0.0	0.0
Total Delay (s/veh)	6.1	3.1	11.8	5.7	12.9	12.2	5.5	10.2	12.7
Queue Length 50th (ft)	1	2	34	2	13	24	0	1	29
Queue Length 95th (ft)	8	19	100	11	49	76	13	6	89
Internal Link Dist (ft)		202		215		382			302
Turn Bay Length (ft)					150			100	
Base Capacity (vph)	1382	1643	1298	1825	1111	1790	1522	1147	1770
Starvation Cap Reductn	0	0	0	0	0	0	0	0	0
Spillback Cap Reductn	0	0	0	0	0	0	0	0	0
Storage Cap Reductn	0	0	0	0	0	0	0	0	0
Reduced v/c Ratio	0.01	0.06	0.23	0.01	0.09	0.10	0.02	0.00	0.12
Intersection Summary									

HCM 7th Signalized Intersection Summary
7: Oldham Parkway & Access 2

Existing + Full Development Traffic Volumes
PM Peak Hour

												
Movement	EBL	EBT	EBR	WBL	WBT	WBR	NBL	NBT	NBR	SBL	SBT	SBR
Lane Configurations												
Traffic Volume (veh/h)	14	20	72	290	20	3	97	180	27	4	199	16
Future Volume (veh/h)	14	20	72	290	20	3	97	180	27	4	199	16
Initial Q (Qb), veh	0	0	0	0	0	0	0	0	0	0	0	0
Lane Width Adj.	1.00	1.00	1.00	1.00	1.00	1.00	1.00	1.00	1.00	1.00	1.00	1.00
Ped-Bike Adj(A_pbT)	1.00		1.00	1.00		1.00	1.00		1.00	1.00		1.00
Parking Bus, Adj	1.00	1.00	1.00	1.00	1.00	1.00	1.00	1.00	1.00	1.00	1.00	1.00
Work Zone On Approach		No			No			No			No	
Adj Sat Flow, veh/h/ln	1870	1870	1870	1870	1870	1870	1870	1870	1870	1870	1870	1870
Adj Flow Rate, veh/h	14	20	73	296	20	3	99	184	0	4	203	16
Peak Hour Factor	0.98	0.98	0.98	0.98	0.98	0.98	0.98	0.98	0.98	0.98	0.98	0.98
Percent Heavy Veh, %	2	2	2	2	2	2	2	2	2	2	2	2
Cap, veh/h	751	123	448	682	553	83	522	566		551	518	41
Arrive On Green	0.35	0.35	0.35	0.35	0.35	0.35	0.30	0.30	0.00	0.30	0.30	0.30
Sat Flow, veh/h	1388	352	1286	1303	1589	238	1162	1870	1585	1200	1711	135
Grp Volume(v), veh/h	14	0	93	296	0	23	99	184	0	4	0	219
Grp Sat Flow(s),veh/h/ln	1388	0	1639	1303	0	1827	1162	1870	1585	1200	0	1846
Q Serve(g_s), s	0.2	0.0	1.0	5.2	0.0	0.2	1.9	2.0	0.0	0.1	0.0	2.4
Cycle Q Clear(g_c), s	0.4	0.0	1.0	6.2	0.0	0.2	4.3	2.0	0.0	2.0	0.0	2.4
Prop In Lane	1.00		0.78	1.00		0.13	1.00		1.00	1.00		0.07
Lane Grp Cap(c), veh/h	751	0	570	682	0	636	522	566		551	0	559
V/C Ratio(X)	0.02	0.00	0.16	0.43	0.00	0.04	0.19	0.33		0.01	0.00	0.39
Avail Cap(c_a), veh/h	4176	0	4613	3897	0	5145	1908	2796		1982	0	2760
HCM Platoon Ratio	1.00	1.00	1.00	1.00	1.00	1.00	1.00	1.00	1.00	1.00	1.00	1.00
Upstream Filter(I)	1.00	0.00	1.00	1.00	0.00	1.00	1.00	1.00	0.00	1.00	0.00	1.00
Uniform Delay (d), s/veh	5.7	0.0	5.8	8.0	0.0	5.5	8.8	6.9	0.0	7.7	0.0	7.1
Incr Delay (d2), s/veh	0.0	0.0	0.1	0.4	0.0	0.0	0.2	0.3	0.0	0.0	0.0	0.4
Initial Q Delay(d3), s/veh	0.0	0.0	0.0	0.0	0.0	0.0	0.0	0.0	0.0	0.0	0.0	0.0
%ile BackOfQ(95%),veh/ln	0.1	0.0	0.3	1.6	0.0	0.1	0.6	0.9	0.0	0.0	0.0	1.1
Unsig. Movement Delay, s/veh												
LnGrp Delay(d), s/veh	5.7	0.0	5.9	8.4	0.0	5.6	9.0	7.3	0.0	7.7	0.0	7.6
LnGrp LOS	A		A	A		A	A	A		A		A
Approach Vol, veh/h	107		319				283			223		
Approach Delay, s/veh	5.9		8.2				7.9			7.6		
Approach LOS	A		A				A			A		
Timer - Assigned Phs	2		4				6			8		
Phs Duration (G+Y+Rc), s	12.3		13.5				12.3			13.5		
Change Period (Y+Rc), s	4.5		4.5				4.5			4.5		
Max Green Setting (Gmax), s	38.5		72.5				38.5			72.5		
Max Q Clear Time (g_c+I1), s	6.3		3.0				4.4			8.2		
Green Ext Time (p_c), s	1.5		0.7				1.4			1.2		
Intersection Summary												
HCM 7th Control Delay, s/veh			7.7									
HCM 7th LOS			A									
Notes												
Unsignalized Delay for [NBR] is excluded from calculations of the approach delay and intersection delay.												

HCM 7th TWSC
8: Oldham Parkway & Access 3

Existing + Full Development Traffic Volumes
PM Peak Hour

Intersection												
Int Delay, s/veh	2.5											
Movement	EBL	EBT	EBR	WBL	WBT	WBR	NBL	NBT	NBR	SBL	SBT	SBR
Lane Configurations		↕			↕		↗	↖			↕	
Traffic Vol, veh/h	7	0	31	35	0	2	33	128	36	2	153	8
Future Vol, veh/h	7	0	31	35	0	2	33	128	36	2	153	8
Conflicting Peds, #/hr	0	0	0	0	0	0	0	0	0	0	0	0
Sign Control	Stop	Stop	Stop	Stop	Stop	Stop	Free	Free	Free	Free	Free	Free
RT Channelized	-	-	None	-	-	None	-	-	None	-	-	None
Storage Length	-	-	-	-	-	-	150	-	-	-	-	-
Veh in Median Storage, #	-	0	-	-	0	-	-	0	-	-	0	-
Grade, %	-	0	-	-	0	-	-	0	-	-	0	-
Peak Hour Factor	98	98	98	98	98	98	98	98	98	98	98	98
Heavy Vehicles, %	2	2	2	2	2	2	2	2	2	2	2	2
Mvmt Flow	7	0	32	36	0	2	34	131	37	2	156	8

Major/Minor	Minor2		Minor1		Major1		Major2					
Conflicting Flow All	362	399	160	377	385	149	164	0	0	167	0	0
Stage 1	164	164	-	216	216	-	-	-	-	-	-	-
Stage 2	198	235	-	160	168	-	-	-	-	-	-	-
Critical Hdwy	7.12	6.52	6.22	7.12	6.52	6.22	4.12	-	-	4.12	-	-
Critical Hdwy Stg 1	6.12	5.52	-	6.12	5.52	-	-	-	-	-	-	-
Critical Hdwy Stg 2	6.12	5.52	-	6.12	5.52	-	-	-	-	-	-	-
Follow-up Hdwy	3.518	4.018	3.318	3.518	4.018	3.318	2.218	-	-	2.218	-	-
Pot Cap-1 Maneuver	594	539	885	581	549	898	1414	-	-	1410	-	-
Stage 1	838	762	-	786	724	-	-	-	-	-	-	-
Stage 2	804	711	-	842	759	-	-	-	-	-	-	-
Platoon blocked, %								-	-	-	-	-
Mov Cap-1 Maneuver	577	525	885	546	535	898	1414	-	-	1410	-	-
Mov Cap-2 Maneuver	577	525	-	546	535	-	-	-	-	-	-	-
Stage 1	836	761	-	767	707	-	-	-	-	-	-	-
Stage 2	783	694	-	811	758	-	-	-	-	-	-	-

Approach	EB		WB		NB		SB	
HCM Control Delay, s/v	9.69		11.92		1.27		0.09	
HCM LOS	A		B					

Minor Lane/Major Mvmt	NBL	NBT	NBR	EBLn1WBLn1	SBL	SBT	SBR
Capacity (veh/h)	1414	-	-	806	558	22	-
HCM Lane V/C Ratio	0.024	-	-	0.048	0.068	0.001	-
HCM Control Delay (s/veh)	7.6	-	-	9.7	11.9	7.6	0
HCM Lane LOS	A	-	-	A	B	A	A
HCM 95th %tile Q(veh)	0.1	-	-	0.2	0.2	0	-

Intersection						
Int Delay, s/veh	0.4					
Movement	EBT	EBR	WBL	WBT	NBL	NBR
Lane Configurations	T			T	T	
Traffic Vol, veh/h	159	4	4	133	4	4
Future Vol, veh/h	159	4	4	133	4	4
Conflicting Peds, #/hr	0	0	0	0	0	0
Sign Control	Free	Free	Free	Free	Stop	Stop
RT Channelized	-	None	-	None	-	None
Storage Length	-	-	-	-	0	-
Veh in Median Storage, #	0	-	-	0	0	-
Grade, %	0	-	-	0	0	-
Peak Hour Factor	98	98	98	98	98	98
Heavy Vehicles, %	2	2	2	2	2	2
Mvmt Flow	162	4	4	136	4	4

Major/Minor	Major1	Major2	Minor1		
Conflicting Flow All	0	0	166	0	308
Stage 1	-	-	-	-	164
Stage 2	-	-	-	-	144
Critical Hdwy	-	-	4.12	-	6.42
Critical Hdwy Stg 1	-	-	-	-	5.42
Critical Hdwy Stg 2	-	-	-	-	5.42
Follow-up Hdwy	-	-	2.218	-	3.518
Pot Cap-1 Maneuver	-	-	1412	-	684
Stage 1	-	-	-	-	865
Stage 2	-	-	-	-	883
Platoon blocked, %	-	-	-	-	-
Mov Cap-1 Maneuver	-	-	1412	-	682
Mov Cap-2 Maneuver	-	-	-	-	682
Stage 1	-	-	-	-	865
Stage 2	-	-	-	-	881

Approach	EB	WB	NB
HCM Control Delay, s/v	0	0.22	9.73
HCM LOS			A

Minor Lane/Major Mvmt	NBLn1	EBT	EBR	WBL	WBT
Capacity (veh/h)	768	-	-	53	-
HCM Lane V/C Ratio	0.011	-	-	0.003	-
HCM Control Delay (s/veh)	9.7	-	-	7.6	0
HCM Lane LOS	A	-	-	A	A
HCM 95th %tile Q(veh)	0	-	-	0	-

Intersection						
Int Delay, s/veh	0.4					
Movement	EBT	EBR	WBL	WBT	NBL	NBR
Lane Configurations	T			T	T	
Traffic Vol, veh/h	159	4	4	133	4	4
Future Vol, veh/h	159	4	4	133	4	4
Conflicting Peds, #/hr	0	0	0	0	0	0
Sign Control	Free	Free	Free	Free	Stop	Stop
RT Channelized	-	None	-	None	-	None
Storage Length	-	-	-	-	0	-
Veh in Median Storage, #	0	-	-	0	0	-
Grade, %	0	-	-	0	0	-
Peak Hour Factor	98	98	98	98	98	98
Heavy Vehicles, %	2	2	2	2	2	2
Mvmt Flow	162	4	4	136	4	4

Major/Minor	Major1	Major2	Minor1	Minor2	Minor3
Conflicting Flow All	0	0	166	0	308
Stage 1	-	-	-	-	164
Stage 2	-	-	-	-	144
Critical Hdwy	-	-	4.12	-	6.42
Critical Hdwy Stg 1	-	-	-	-	5.42
Critical Hdwy Stg 2	-	-	-	-	5.42
Follow-up Hdwy	-	-	2.218	-	3.518
Pot Cap-1 Maneuver	-	-	1412	-	684
Stage 1	-	-	-	-	865
Stage 2	-	-	-	-	883
Platoon blocked, %	-	-	-	-	-
Mov Cap-1 Maneuver	-	-	1412	-	682
Mov Cap-2 Maneuver	-	-	-	-	682
Stage 1	-	-	-	-	865
Stage 2	-	-	-	-	881

Approach	EB	WB	NB
HCM Control Delay, s/v	0	0.22	9.73
HCM LOS			A

Minor Lane/Major Mvmt	NBLn1	EBT	EBR	WBL	WBT
Capacity (veh/h)	768	-	-	53	-
HCM Lane V/C Ratio	0.011	-	-	0.003	-
HCM Control Delay (s/veh)	9.7	-	-	7.6	0
HCM Lane LOS	A	-	-	A	A
HCM 95th %tile Q(veh)	0	-	-	0	-

Intersection						
Int Delay, s/veh	3.9					
Movement	WBL	WBR	NBT	NBR	SBL	SBT
Lane Configurations	↘		↗		↘	↗
Traffic Vol, veh/h	139	13	146	15	15	162
Future Vol, veh/h	139	13	146	15	15	162
Conflicting Peds, #/hr	0	0	0	0	0	0
Sign Control	Stop	Stop	Free	Free	Free	Free
RT Channelized	-	None	-	None	-	None
Storage Length	0	-	-	-	100	-
Veh in Median Storage, #	0	-	0	-	-	0
Grade, %	0	-	0	-	-	0
Peak Hour Factor	98	98	98	98	98	98
Heavy Vehicles, %	2	2	2	2	2	2
Mvmt Flow	142	13	149	15	15	165

Major/Minor	Minor1	Major1	Major2		
Conflicting Flow All	353	157	0	0	164
Stage 1	157	-	-	-	-
Stage 2	196	-	-	-	-
Critical Hdwy	6.42	6.22	-	-	4.12
Critical Hdwy Stg 1	5.42	-	-	-	-
Critical Hdwy Stg 2	5.42	-	-	-	-
Follow-up Hdwy	3.518	3.318	-	-	2.218
Pot Cap-1 Maneuver	645	889	-	-	1414
Stage 1	872	-	-	-	-
Stage 2	837	-	-	-	-
Platoon blocked, %			-	-	-
Mov Cap-1 Maneuver	638	889	-	-	1414
Mov Cap-2 Maneuver	678	-	-	-	-
Stage 1	872	-	-	-	-
Stage 2	828	-	-	-	-

Approach	WB	NB	SB
HCM Control Delay, s/v	11.7	0	0.64
HCM LOS	B		

Minor Lane/Major Mvmt	NBT	NBRWBLn1	SBL	SBT
Capacity (veh/h)	-	-	692	1414
HCM Lane V/C Ratio	-	-	0.224	0.011
HCM Control Delay (s/veh)	-	-	11.7	7.6
HCM Lane LOS	-	-	B	A
HCM 95th %tile Q(veh)	-	-	0.9	0

Intersection						
Int Delay, s/veh	1.3					
Movement	WBL	WBR	NBT	NBR	SBL	SBT
Lane Configurations	W		T		T	T
Traffic Vol, veh/h	13	20	144	15	22	164
Future Vol, veh/h	13	20	144	15	22	164
Conflicting Peds, #/hr	0	0	0	0	0	0
Sign Control	Stop	Stop	Free	Free	Free	Free
RT Channelized	-	None	-	None	-	None
Storage Length	-	-	-	-	100	-
Veh in Median Storage, #	0	-	0	-	-	0
Grade, %	0	-	0	-	-	0
Peak Hour Factor	98	98	98	98	98	98
Heavy Vehicles, %	2	2	2	2	2	2
Mvmt Flow	13	20	147	15	22	167

Major/Minor	Minor1	Major1	Major2			
Conflicting Flow All	367	155	0	0	162	0
Stage 1	155	-	-	-	-	-
Stage 2	212	-	-	-	-	-
Critical Hdwy	6.42	6.22	-	-	4.12	-
Critical Hdwy Stg 1	5.42	-	-	-	-	-
Critical Hdwy Stg 2	5.42	-	-	-	-	-
Follow-up Hdwy	3.518	3.318	-	-	2.218	-
Pot Cap-1 Maneuver	633	891	-	-	1417	-
Stage 1	874	-	-	-	-	-
Stage 2	823	-	-	-	-	-
Platoon blocked, %			-	-		-
Mov Cap-1 Maneuver	623	891	-	-	1417	-
Mov Cap-2 Maneuver	666	-	-	-	-	-
Stage 1	874	-	-	-	-	-
Stage 2	810	-	-	-	-	-

Approach	WB	NB	SB
HCM Control Delay, s/v	9.78	0	0.9
HCM LOS	A		

Minor Lane/Major Mvmt	NBT	NBRWBLn1	SBL	SBT
Capacity (veh/h)	-	-	787	1417
HCM Lane V/C Ratio	-	-	0.043	0.016
HCM Control Delay (s/veh)	-	-	9.8	7.6
HCM Lane LOS	-	-	A	A
HCM 95th %tile Q(veh)	-	-	0.1	0

HCM 7th TWSC
 13: Jefferson Street & Access 6

Existing + Full Development Traffic Volumes
 PM Peak Hour

Intersection												
Int Delay, s/veh	3.9											
Movement	EBL	EBT	EBR	WBL	WBT	WBR	NBL	NBT	NBR	SBL	SBT	SBR
Lane Configurations		↕			↕		↗	↘		↗	↘	
Traffic Vol, veh/h	27	0	13	32	0	59	15	115	34	65	141	30
Future Vol, veh/h	27	0	13	32	0	59	15	115	34	65	141	30
Conflicting Peds, #/hr	0	0	0	0	0	0	0	0	0	0	0	0
Sign Control	Stop	Stop	Stop	Stop	Stop	Stop	Free	Free	Free	Free	Free	Free
RT Channelized	-	-	None	-	-	None	-	-	None	-	-	None
Storage Length	-	-	-	-	-	-	100	-	-	100	-	-
Veh in Median Storage, #	-	0	-	-	0	-	-	0	-	-	0	-
Grade, %	-	0	-	-	0	-	-	0	-	-	0	-
Peak Hour Factor	98	98	98	98	98	98	98	98	98	98	98	98
Heavy Vehicles, %	2	2	2	2	2	2	2	2	2	2	2	2
Mvmt Flow	28	0	13	33	0	60	15	117	35	66	144	31

Major/Minor	Minor2		Minor1		Major1		Major2					
Conflicting Flow All	440	474	159	442	472	135	174	0	0	152	0	0
Stage 1	292	292	-	165	165	-	-	-	-	-	-	-
Stage 2	148	183	-	277	307	-	-	-	-	-	-	-
Critical Hdwy	7.12	6.52	6.22	7.12	6.52	6.22	4.12	-	-	4.12	-	-
Critical Hdwy Stg 1	6.12	5.52	-	6.12	5.52	-	-	-	-	-	-	-
Critical Hdwy Stg 2	6.12	5.52	-	6.12	5.52	-	-	-	-	-	-	-
Follow-up Hdwy	3.518	4.018	3.318	3.518	4.018	3.318	2.218	-	-	2.218	-	-
Pot Cap-1 Maneuver	528	489	886	526	490	914	1402	-	-	1429	-	-
Stage 1	716	671	-	837	761	-	-	-	-	-	-	-
Stage 2	855	748	-	730	661	-	-	-	-	-	-	-
Platoon blocked, %								-	-	-	-	-
Mov Cap-1 Maneuver	465	461	886	489	462	914	1402	-	-	1429	-	-
Mov Cap-2 Maneuver	465	461	-	489	462	-	-	-	-	-	-	-
Stage 1	683	640	-	828	753	-	-	-	-	-	-	-
Stage 2	790	740	-	686	630	-	-	-	-	-	-	-

Approach	EB		WB		NB		SB	
HCM Control Delay, s/v12.07			10.93		0.69		2.1	
HCM LOS	B		B					

Minor Lane/Major Mvmt	NBL	NBT	NBR	EBLn1	WBLn1	SBL	SBT	SBR
Capacity (veh/h)	1402	-	-	550	700	1429	-	-
HCM Lane V/C Ratio	0.011	-	-	0.074	0.133	0.046	-	-
HCM Control Delay (s/veh)	7.6	-	-	12.1	10.9	7.6	-	-
HCM Lane LOS	A	-	-	B	B	A	-	-
HCM 95th %tile Q(veh)	0	-	-	0.2	0.5	0.1	-	-

Intersection						
Int Delay, s/veh	1.6					
Movement	WBL	WBR	NBT	NBR	SBL	SBT
Lane Configurations	W		T		T	T
Traffic Vol, veh/h	19	19	179	22	57	217
Future Vol, veh/h	19	19	179	22	57	217
Conflicting Peds, #/hr	0	0	0	0	0	0
Sign Control	Stop	Stop	Free	Free	Free	Free
RT Channelized	-	None	-	None	-	None
Storage Length	0	-	-	-	100	-
Veh in Median Storage, #	0	-	0	-	-	0
Grade, %	0	-	0	-	-	0
Peak Hour Factor	98	98	98	98	98	98
Heavy Vehicles, %	2	2	2	2	2	2
Mvmt Flow	19	19	183	22	58	221

Major/Minor	Minor1	Major1	Major2		
Conflicting Flow All	532	194	0	0	205
Stage 1	194	-	-	-	-
Stage 2	338	-	-	-	-
Critical Hdwy	6.42	6.22	-	-	4.12
Critical Hdwy Stg 1	5.42	-	-	-	-
Critical Hdwy Stg 2	5.42	-	-	-	-
Follow-up Hdwy	3.518	3.318	-	-	2.218
Pot Cap-1 Maneuver	508	848	-	-	1366
Stage 1	839	-	-	-	-
Stage 2	723	-	-	-	-
Platoon blocked, %			-	-	-
Mov Cap-1 Maneuver	487	848	-	-	1366
Mov Cap-2 Maneuver	563	-	-	-	-
Stage 1	839	-	-	-	-
Stage 2	692	-	-	-	-

Approach	WB	NB	SB
HCM Control Delay, s/v10.65		0	1.61
HCM LOS	B		

Minor Lane/Major Mvmt	NBT	NBRWBLn1	SBL	SBT
Capacity (veh/h)	-	-	676	1366
HCM Lane V/C Ratio	-	-	0.057	0.043
HCM Control Delay (s/veh)	-	-	10.6	7.8
HCM Lane LOS	-	-	B	A
HCM 95th %tile Q(veh)	-	-	0.2	0.1

HCM Unsignalized Intersection Capacity Analysis Existing + Full Development Traffic Volumes
 15: Access 8 & Oldham Parkway PM Peak Hour



Movement	EBT	EBR	WBL	WBT	NBL	NBR	
Lane Configurations	↑↑↑			↑↑		↗	
Traffic Volume (veh/h)	749	7	0	826	0	40	
Future Volume (Veh/h)	749	7	0	826	0	40	
Sign Control	Free			Free	Stop		
Grade	0%			0%	0%		
Peak Hour Factor	0.98	0.98	0.98	0.98	0.98	0.98	
Hourly flow rate (vph)	764	7	0	843	0	41	
Pedestrians							
Lane Width (ft)							
Walking Speed (ft/s)							
Percent Blockage							
Right turn flare (veh)							
Median type	None			None			
Median storage (veh)							
Upstream signal (ft)	1111			281			
pX, platoon unblocked							
vC, conflicting volume			771	1189	195		
vC1, stage 1 conf vol							
vC2, stage 2 conf vol							
vCu, unblocked vol			771	1189	195		
tC, single (s)			4.1	6.8	6.9		
tC, 2 stage (s)							
tF (s)			2.2	3.5	3.3		
p0 queue free %			100	100	95		
cM capacity (veh/h)			840	181	814		
Direction, Lane #	EB 1	EB 2	EB 3	EB 4	WB 1	WB 2	NB 1
Volume Total	218	218	218	116	422	422	41
Volume Left	0	0	0	0	0	0	0
Volume Right	0	0	0	7	0	0	41
cSH	1700	1700	1700	1700	1700	1700	814
Volume to Capacity	0.13	0.13	0.13	0.07	0.25	0.25	0.05
Queue Length 95th (ft)	0	0	0	0	0	0	4
Control Delay (s/veh)	0.0	0.0	0.0	0.0	0.0	0.0	9.7
Lane LOS							A
Approach Delay (s/veh)	0.0			0.0			9.7
Approach LOS							A
Intersection Summary							
Average Delay			0.2				
Intersection Capacity Utilization			26.2%		ICU Level of Service		A
Analysis Period (min)			15				

Queues

Existing + Full Development Traffic Volumes

1: Ward Road & Oldham Parkway

SAT Peak Hour























Lane Group	EBL	EBT	WBT	NBL	NBT	SBL	SBT	SBR
Lane Group Flow (vph)	157	44	196	31	591	163	381	189
v/c Ratio	0.57	0.10	0.42	0.16	0.56	0.49	0.21	0.21
Control Delay (s/veh)	33.4	12.9	14.1	35.4	23.2	33.2	12.2	3.4
Queue Delay	0.0	0.0	0.0	0.0	0.0	0.0	0.0	0.0
Total Delay (s/veh)	33.4	12.9	14.1	35.4	23.2	33.2	12.2	3.4
Queue Length 50th (ft)	55	5	27	12	101	59	33	0
Queue Length 95th (ft)	140	32	95	45	202	148	107	39
Internal Link Dist (ft)		116	246		459		353	
Turn Bay Length (ft)				110		105		
Base Capacity (vph)	660	997	960	457	2408	625	2709	1256
Starvation Cap Reductn	0	0	0	0	0	0	0	0
Spillback Cap Reductn	0	0	0	0	0	0	0	0
Storage Cap Reductn	0	0	0	0	0	0	0	0
Reduced v/c Ratio	0.24	0.04	0.20	0.07	0.25	0.26	0.14	0.15

Intersection Summary

HCM 7th Signalized Intersection Summary
1: Ward Road & Oldham Parkway

Existing + Full Development Traffic Volumes
SAT Peak Hour

												
Movement	EBL	EBT	EBR	WBL	WBT	WBR	NBL	NBT	NBR	SBL	SBT	SBR
Lane Configurations												
Traffic Volume (veh/h)	154	16	27	37	17	138	30	544	35	160	373	185
Future Volume (veh/h)	154	16	27	37	17	138	30	544	35	160	373	185
Initial Q (Qb), veh	0	0	0	0	0	0	0	0	0	0	0	0
Lane Width Adj.	1.00	1.00	1.00	1.00	1.00	1.00	1.00	1.00	1.00	1.00	1.00	1.00
Ped-Bike Adj(A_pbT)	1.00		1.00	1.00		1.00	1.00		1.00	1.00		1.00
Parking Bus, Adj	1.00	1.00	1.00	1.00	1.00	1.00	1.00	1.00	1.00	1.00	1.00	1.00
Work Zone On Approach		No			No			No			No	
Adj Sat Flow, veh/h/ln	1870	1870	1870	1870	1870	1870	1870	1870	1870	1870	1870	1870
Adj Flow Rate, veh/h	157	16	28	38	17	141	31	555	36	163	381	189
Peak Hour Factor	0.98	0.98	0.98	0.98	0.98	0.98	0.98	0.98	0.98	0.98	0.98	0.98
Percent Heavy Veh, %	2	2	2	2	2	2	2	2	2	2	2	2
Cap, veh/h	380	110	192	126	44	206	63	1125	73	217	1488	664
Arrive On Green	0.18	0.18	0.18	0.18	0.18	0.18	0.04	0.33	0.33	0.12	0.42	0.42
Sat Flow, veh/h	1228	610	1068	200	247	1144	1781	3388	219	1781	3554	1585
Grp Volume(v), veh/h	157	0	44	196	0	0	31	291	300	163	381	189
Grp Sat Flow(s),veh/h/ln	1228	0	1678	1590	0	0	1781	1777	1831	1781	1777	1585
Q Serve(g_s), s	0.0	0.0	1.1	2.5	0.0	0.0	0.8	6.2	6.3	4.2	3.3	3.8
Cycle Q Clear(g_c), s	5.4	0.0	1.1	5.4	0.0	0.0	0.8	6.2	6.3	4.2	3.3	3.8
Prop In Lane	1.00		0.64	0.19		0.72	1.00		0.12	1.00		1.00
Lane Grp Cap(c), veh/h	380	0	302	376	0	0	63	590	608	217	1488	664
V/C Ratio(X)	0.41	0.00	0.15	0.52	0.00	0.00	0.49	0.49	0.49	0.75	0.26	0.28
Avail Cap(c_a), veh/h	1108	0	1296	1298	0	0	608	1610	1659	832	3667	1636
HCM Platoon Ratio	1.00	1.00	1.00	1.00	1.00	1.00	1.00	1.00	1.00	1.00	1.00	1.00
Upstream Filter(I)	1.00	0.00	1.00	1.00	0.00	0.00	1.00	1.00	1.00	1.00	1.00	1.00
Uniform Delay (d), s/veh	18.3	0.0	16.5	18.3	0.0	0.0	22.6	12.7	12.8	20.3	9.0	9.2
Incr Delay (d2), s/veh	0.7	0.0	0.2	1.1	0.0	0.0	5.9	0.9	0.9	5.1	0.1	0.3
Initial Q Delay(d3), s/veh	0.0	0.0	0.0	0.0	0.0	0.0	0.0	0.0	0.0	0.0	0.0	0.0
%ile BackOfQ(95%),veh/ln	2.8	0.0	0.7	3.3	0.0	0.0	0.7	3.9	4.0	3.3	1.8	1.9
Unsig. Movement Delay, s/veh												
LnGrp Delay(d), s/veh	19.0	0.0	16.7	19.4	0.0	0.0	28.5	13.7	13.6	25.4	9.2	9.5
LnGrp LOS	B		B	B			C	B	B	C	A	A
Approach Vol, veh/h		201			196			622			733	
Approach Delay, s/veh		18.5			19.4			14.4			12.9	
Approach LOS		B			B			B			B	
Timer - Assigned Phs	1	2		4	5	6		8				
Phs Duration (G+Y+Rc), s	7.4	25.7		14.7	11.5	21.6		14.7				
Change Period (Y+Rc), s	5.7	5.7		6.1	5.7	5.7		6.1				
Max Green Setting (Gmax), s	16.3	49.3		36.9	22.3	43.3		36.9				
Max Q Clear Time (g_c+I1), s	2.8	5.8		7.4	6.2	8.3		7.4				
Green Ext Time (p_c), s	0.0	5.0		1.2	0.4	5.6		0.8				
Intersection Summary												
HCM 7th Control Delay, s/veh			14.8									
HCM 7th LOS			B									
Notes												
User approved pedestrian interval to be less than phase max green.												

HCM 7th TWSC
 2: Jefferson Street & Oldham Parkway

Existing + Full Development Traffic Volumes
 SAT Peak Hour

Intersection												
Int Delay, s/veh	3.4											
Movement	EBL	EBT	EBR	WBL	WBT	WBR	NBL	NBT	NBR	SBL	SBT	SBR
Lane Configurations	↖	↖↗		↖	↖↗				↖			↖
Traffic Vol, veh/h	3	606	24	273	318	307	0	0	235	0	0	3
Future Vol, veh/h	3	606	24	273	318	307	0	0	235	0	0	3
Conflicting Peds, #/hr	0	0	0	0	0	0	0	0	0	0	0	0
Sign Control	Free	Free	Free	Free	Free	Free	Stop	Stop	Stop	Stop	Stop	Stop
RT Channelized	-	-	None	-	-	None	-	-	None	-	-	None
Storage Length	150	-	-	200	-	-	-	-	0	-	-	0
Veh in Median Storage, #	-	0	-	-	0	-	-	0	-	-	0	-
Grade, %	-	0	-	-	0	-	-	0	-	-	0	-
Peak Hour Factor	98	98	98	98	98	98	98	98	98	98	98	98
Heavy Vehicles, %	2	2	2	2	2	2	2	2	2	2	2	2
Mvmt Flow	3	618	24	279	324	313	0	0	240	0	0	3

Major/Minor	Major1			Major2			Minor1			Minor2		
Conflicting Flow All	638	0	0	643	0	0	-	-	321	-	-	319
Stage 1	-	-	-	-	-	-	-	-	-	-	-	-
Stage 2	-	-	-	-	-	-	-	-	-	-	-	-
Critical Hdwy	4.14	-	-	4.14	-	-	-	-	6.94	-	-	6.94
Critical Hdwy Stg 1	-	-	-	-	-	-	-	-	-	-	-	-
Critical Hdwy Stg 2	-	-	-	-	-	-	-	-	-	-	-	-
Follow-up Hdwy	2.22	-	-	2.22	-	-	-	-	3.32	-	-	3.32
Pot Cap-1 Maneuver	942	-	-	938	-	-	0	0	674	0	0	677
Stage 1	-	-	-	-	-	-	0	0	-	0	0	-
Stage 2	-	-	-	-	-	-	0	0	-	0	0	-
Platoon blocked, %		-	-		-	-				-	-	
Mov Cap-1 Maneuver	942	-	-	938	-	-	-	-	674	-	-	677
Mov Cap-2 Maneuver	-	-	-	-	-	-	-	-	-	-	-	-
Stage 1	-	-	-	-	-	-	-	-	-	-	-	-
Stage 2	-	-	-	-	-	-	-	-	-	-	-	-

Approach	EB			WB			NB			SB		
HCM Control Delay, s/v	0.04			3.18			13.26			10.34		
HCM LOS							B			B		

Minor Lane/Major Mvmt	NBLn1	EBL	EBT	EBR	WBL	WBT	WBR	SBLn1
Capacity (veh/h)	674	942	-	-	938	-	-	677
HCM Lane V/C Ratio	0.356	0.003	-	-	0.297	-	-	0.005
HCM Control Delay (s/veh)	13.3	8.8	-	-	10.5	-	-	10.3
HCM Lane LOS	B	A	-	-	B	-	-	B
HCM 95th %tile Q(veh)	1.6	0	-	-	1.2	-	-	0

Queues
3: M-291 & Oldham Parkway





























Existing + Full Development Traffic Volumes
SAT Peak Hour



Lane Group	EBL	EBR	NBL	NBT	SBT	SBR
Lane Group Flow (vph)	612	293	298	1114	1021	601
v/c Ratio	0.81	0.41	0.69	0.32	0.41	0.56
Control Delay (s/veh)	53.9	1.7	48.8	1.3	21.6	4.6
Queue Delay	0.0	0.0	0.0	0.0	0.0	0.0
Total Delay (s/veh)	53.9	1.7	48.8	1.3	21.6	4.6
Queue Length 50th (ft)	232	0	127	4	185	11
Queue Length 95th (ft)	286	0	168	11	245	91
Internal Link Dist (ft)				1398	887	
Turn Bay Length (ft)	345		250			180
Base Capacity (vph)	881	766	486	3395	2450	1060
Starvation Cap Reductn	0	0	0	0	0	0
Spillback Cap Reductn	0	0	0	0	0	0
Storage Cap Reductn	0	0	0	0	0	0
Reduced v/c Ratio	0.69	0.38	0.61	0.33	0.42	0.57
Intersection Summary						

HCM 7th Signalized Intersection Summary
3: M-291 & Oldham Parkway

Existing + Full Development Traffic Volumes
SAT Peak Hour

												
Movement	EBL	EBT	EBR	WBL	WBT	WBR	NBL	NBT	NBR	SBL	SBT	SBR
Lane Configurations	 		 	 			 	  		 		
Traffic Volume (veh/h)	600	0	287	0	0	0	292	1092	0	0	1001	589
Future Volume (veh/h)	600	0	287	0	0	0	292	1092	0	0	1001	589
Initial Q (Qb), veh	0	0	0	0	0	0	0	0	0	0	0	0
Lane Width Adj.	1.00	1.00	1.00	1.00	1.00	1.00	1.00	1.00	1.00	1.00	1.00	1.00
Ped-Bike Adj(A_pbT)	1.00		1.00	1.00		1.00	1.00		1.00	1.00		1.00
Parking Bus, Adj	1.00	1.00	1.00	1.00	1.00	1.00	1.00	1.00	1.00	1.00	1.00	1.00
Work Zone On Approach		No			No			No			No	
Adj Sat Flow, veh/h/ln	1870	1870	1870	1870	1870	1870	1870	1870	1870	1870	1870	1870
Adj Flow Rate, veh/h	612	0	0	0	0	0	298	1114	0	0	1021	0
Peak Hour Factor	0.98	0.98	0.98	0.98	0.98	0.98	0.98	0.98	0.98	0.98	0.98	0.98
Percent Heavy Veh, %	2	2	2	2	2	2	2	2	2	2	2	2
Cap, veh/h	698	381		3	2	1	1258	3463		3	1323	
Arrive On Green	0.20	0.00	0.00	0.00	0.00	0.00	0.73	1.00	0.00	0.00	0.26	0.00
Sat Flow, veh/h	3456	1870	1585	3456	1870	1585	3456	5106	1585	3456	5106	1585
Grp Volume(v), veh/h	612	0	0	0	0	0	298	1114	0	0	1021	0
Grp Sat Flow(s),veh/h/ln	1728	1870	1585	1728	1870	1585	1728	1702	1585	1728	1702	1585
Q Serve(g_s), s	20.6	0.0	0.0	0.0	0.0	0.0	3.4	0.0	0.0	0.0	22.2	0.0
Cycle Q Clear(g_c), s	20.6	0.0	0.0	0.0	0.0	0.0	3.4	0.0	0.0	0.0	22.2	0.0
Prop In Lane	1.00		1.00	1.00		1.00	1.00		1.00	1.00		1.00
Lane Grp Cap(c), veh/h	698	381		3	2	1	1258	3463		3	1323	
V/C Ratio(X)	0.88	0.00		0.00	0.00	0.00	0.24	0.32		0.00	0.77	
Avail Cap(c_a), veh/h	887	507		144	109	92	1258	3463		144	1591	
HCM Platoon Ratio	1.00	1.00	1.00	1.00	1.00	1.00	2.00	2.00	2.00	1.00	1.00	1.00
Upstream Filter(I)	1.00	0.00	0.00	0.00	0.00	0.00	0.87	0.87	0.00	0.00	1.00	0.00
Uniform Delay (d), s/veh	46.4	0.0	0.0	0.0	0.0	0.0	10.8	0.0	0.0	0.0	41.2	0.0
Incr Delay (d2), s/veh	8.2	0.0	0.0	0.0	0.0	0.0	0.1	0.2	0.0	0.0	4.4	0.0
Initial Q Delay(d3), s/veh	0.0	0.0	0.0	0.0	0.0	0.0	0.0	0.0	0.0	0.0	0.0	0.0
%ile BackOfQ(95%),veh/ln	14.8	0.0	0.0	0.0	0.0	0.0	2.1	0.1	0.0	0.0	14.6	0.0
Unsig. Movement Delay, s/veh												
LnGrp Delay(d), s/veh	54.7	0.0	0.0	0.0	0.0	0.0	10.9	0.2	0.0	0.0	45.6	0.0
LnGrp LOS	D						B	A			D	
Approach Vol, veh/h		612			0			1412			1021	
Approach Delay, s/veh		54.7			0.0			2.5			45.6	
Approach LOS		D						A			D	
Timer - Assigned Phs	1	2	3	4	5	6	7	8				
Phs Duration (G+Y+Rc), s	0.0	88.6	0.0	31.4	50.9	37.7	31.4	0.0				
Change Period (Y+Rc), s	6.7	* 7.2	7.3	7.0	7.2	6.6	7.2	* 7				
Max Green Setting (Gmax), s	5.0	* 50	5.0	32.5	17.0	37.4	30.8	* 7				
Max Q Clear Time (g_c+I1), s	0.0	2.0	0.0	0.0	5.4	24.2	22.6	0.0				
Green Ext Time (p_c), s	0.0	13.8	0.0	0.0	0.8	6.9	1.6	0.0				
Intersection Summary												
HCM 7th Control Delay, s/veh			27.4									
HCM 7th LOS			C									
Notes												
User approved pedestrian interval to be less than phase max green.												
* HCM 7th computational engine requires equal clearance times for the phases crossing the barrier.												

Unsignalized Delay for [NBR, EBR, SBR] is excluded from calculations of the approach delay and intersection delay.

Queues

Existing + Full Development Traffic Volumes

4: Jefferson Street & Persels Road

SAT Peak Hour























Lane Group	EBL	EBT	WBL	WBT	NBL	NBT	SBL	SBT
Lane Group Flow (vph)	76	184	74	243	9	116	206	125
v/c Ratio	0.11	0.10	0.09	0.26	0.02	0.41	0.50	0.22
Control Delay (s/veh)	12.2	19.9	15.8	18.7	27.2	24.1	35.5	13.9
Queue Delay	0.0	0.0	0.0	0.0	0.0	0.0	0.0	0.0
Total Delay (s/veh)	12.2	19.9	15.8	18.7	27.2	24.1	35.5	13.9
Queue Length 50th (ft)	23	41	26	92	5	28	124	23
Queue Length 95th (ft)	51	76	64	195	16	86	177	77
Internal Link Dist (ft)		1272		101		1173		315
Turn Bay Length (ft)	110		175		110		150	
Base Capacity (vph)	668	1698	787	911	307	503	413	568
Starvation Cap Reductn	0	0	0	0	0	0	0	0
Spillback Cap Reductn	0	0	0	0	0	0	0	0
Storage Cap Reductn	0	0	0	0	0	0	0	0
Reduced v/c Ratio	0.11	0.11	0.09	0.27	0.03	0.23	0.50	0.22

Intersection Summary

HCM 7th Signalized Intersection Summary
4: Jefferson Street & Persels Road

Existing + Full Development Traffic Volumes
SAT Peak Hour













												
Movement	EBL	EBT	EBR	WBL	WBT	WBR	NBL	NBT	NBR	SBL	SBT	SBR
Lane Configurations												
Traffic Volume (veh/h)	74	177	3	73	189	49	9	39	74	202	41	81
Future Volume (veh/h)	74	177	3	73	189	49	9	39	74	202	41	81
Initial Q (Qb), veh	0	0	0	0	0	0	0	0	0	0	0	0
Lane Width Adj.	1.00	1.00	1.00	1.00	1.00	1.00	1.00	1.00	1.00	1.00	1.00	1.00
Ped-Bike Adj(A_pbT)	1.00		1.00	1.00		1.00	1.00		1.00	1.00		1.00
Parking Bus, Adj	1.00	1.00	1.00	1.00	1.00	1.00	1.00	1.00	1.00	1.00	1.00	1.00
Work Zone On Approach		No			No			No			No	
Adj Sat Flow, veh/h/ln	1870	1870	1870	1870	1870	1870	1870	1870	1870	1870	1870	1870
Adj Flow Rate, veh/h	76	181	3	74	193	50	9	40	76	206	42	83
Peak Hour Factor	0.98	0.98	0.98	0.98	0.98	0.98	0.98	0.98	0.98	0.98	0.98	0.98
Percent Heavy Veh, %	2	2	2	2	2	2	2	2	2	2	2	2
Cap, veh/h	823	447	7	980	246	64	257	72	137	329	119	235
Arrive On Green	0.43	0.13	0.13	0.16	0.06	0.06	0.02	0.12	0.12	0.11	0.21	0.21
Sat Flow, veh/h	1781	3577	59	1781	1432	371	1781	577	1096	1781	561	1109
Grp Volume(v), veh/h	76	90	94	74	0	243	9	0	116	206	0	125
Grp Sat Flow(s),veh/h/ln	1781	1777	1860	1781	0	1804	1781	0	1673	1781	0	1671
Q Serve(g_s), s	0.0	5.6	5.6	0.0	0.0	16.0	0.5	0.0	7.8	11.8	0.0	7.6
Cycle Q Clear(g_c), s	0.0	5.6	5.6	0.0	0.0	16.0	0.5	0.0	7.8	11.8	0.0	7.6
Prop In Lane	1.00		0.03	1.00		0.21	1.00		0.66	1.00		0.66
Lane Grp Cap(c), veh/h	823	222	232	980	0	309	257	0	209	329	0	354
V/C Ratio(X)	0.09	0.40	0.41	0.08	0.00	0.79	0.04	0.00	0.55	0.63	0.00	0.35
Avail Cap(c_a), veh/h	823	637	666	980	0	646	367	0	446	329	0	487
HCM Platoon Ratio	1.00	1.00	1.00	0.33	0.33	0.33	1.00	1.00	1.00	1.00	1.00	1.00
Upstream Filter(I)	1.00	1.00	1.00	1.00	0.00	1.00	1.00	0.00	1.00	1.00	0.00	1.00
Uniform Delay (d), s/veh	19.6	48.4	48.4	23.0	0.0	54.4	43.9	0.0	49.4	38.6	0.0	40.3
Incr Delay (d2), s/veh	0.1	5.4	5.2	0.0	0.0	17.9	0.1	0.0	4.8	4.3	0.0	1.3
Initial Q Delay(d3), s/veh	0.0	0.0	0.0	0.0	0.0	0.0	0.0	0.0	0.0	0.0	0.0	0.0
%ile BackOfQ(95%),veh/ln	2.2	5.0	5.3	3.0	0.0	14.3	0.4	0.0	6.4	9.3	0.0	5.9
Unsig. Movement Delay, s/veh												
LnGrp Delay(d), s/veh	19.7	53.8	53.6	23.0	0.0	72.4	44.0	0.0	54.2	42.9	0.0	41.6
LnGrp LOS	B	D	D	C		E	D		D	D		D
Approach Vol, veh/h		260			317			125				331
Approach Delay, s/veh		43.7			60.8			53.5				42.4
Approach LOS		D			E			D				D
Timer - Assigned Phs	1	2	3	4	5	6	7	8				
Phs Duration (G+Y+Rc), s	62.0	20.0	18.0	20.0	56.4	25.6	7.6	30.4				
Change Period (Y+Rc), s	5.0	5.0	5.0	5.0	5.0	5.0	5.0	5.0				
Max Green Setting (Gmax), s	12.0	43.0	13.0	32.0	12.0	43.0	10.0	35.0				
Max Q Clear Time (g_c+I1), s	2.0	7.6	13.8	9.8	2.0	18.0	2.5	9.6				
Green Ext Time (p_c), s	0.1	2.0	0.0	1.0	0.2	2.6	0.0	1.2				
Intersection Summary												
HCM 7th Control Delay, s/veh			49.7									
HCM 7th LOS			D									

Queues

Existing + Full Development Traffic Volumes

























5: M-291 & Persels Road/Bailey Road

SAT Peak Hour

												
Lane Group	EBL	EBT	EBR	WBL	WBT	WBR	NBL	NBT	NBR	SBL	SBT	SBR
Lane Group Flow (vph)	264	118	155	114	93	66	142	1103	135	51	1053	323
v/c Ratio	0.70	0.59	0.44	0.35	0.54	0.19	0.67	0.44	0.15	0.25	0.64	0.35
Control Delay (s/veh)	51.9	61.1	10.4	54.4	63.3	1.3	65.8	22.3	2.2	36.6	13.3	1.1
Queue Delay	0.0	0.0	0.0	0.0	0.0	0.0	0.0	0.0	0.0	0.0	0.0	0.0
Total Delay (s/veh)	51.9	61.1	10.4	54.4	63.3	1.3	65.8	22.3	2.2	36.6	13.3	1.1
Queue Length 50th (ft)	97	91	15	42	70	0	106	230	0	35	101	0
Queue Length 95th (ft)	138	139	34	74	123	0	171	241	25	80	124	3
Internal Link Dist (ft)		341			1421			2289			1398	
Turn Bay Length (ft)	200		150	280		290	310		350	330		
Base Capacity (vph)	387	310	433	320	222	370	264	2639	896	206	1632	904
Starvation Cap Reductn	0	0	0	0	0	0	0	0	0	0	0	0
Spillback Cap Reductn	0	0	0	0	0	0	0	0	0	0	0	0
Storage Cap Reductn	0	0	0	0	0	0	0	0	0	0	0	0
Reduced v/c Ratio	0.68	0.38	0.36	0.36	0.42	0.18	0.54	0.42	0.15	0.25	0.65	0.36
Intersection Summary												

HCM 7th Signalized Intersection Summary
5: M-291 & Persels Road/Bailey Road

Existing + Full Development Traffic Volumes
SAT Peak Hour

												
Movement	EBL	EBT	EBR	WBL	WBT	WBR	NBL	NBT	NBR	SBL	SBT	SBR
Lane Configurations												
Traffic Volume (veh/h)	259	116	152	112	91	65	139	1081	132	50	1032	317
Future Volume (veh/h)	259	116	152	112	91	65	139	1081	132	50	1032	317
Initial Q (Qb), veh	0	0	0	0	0	0	0	0	0	0	0	0
Lane Width Adj.	1.00	1.00	1.00	1.00	1.00	1.00	1.00	1.00	1.00	1.00	1.00	1.00
Ped-Bike Adj(A_pbT)	1.00		1.00	1.00		1.00	1.00		1.00	1.00		1.00
Parking Bus, Adj	1.00	1.00	1.00	1.00	1.00	1.00	1.00	1.00	1.00	1.00	1.00	1.00
Work Zone On Approach		No			No			No			No	
Adj Sat Flow, veh/h/ln	1870	1870	1856	1870	1870	1870	1870	1870	1870	1870	1870	1870
Adj Flow Rate, veh/h	264	118	155	114	93	66	142	1103	0	51	1053	0
Peak Hour Factor	0.98	0.98	0.98	0.98	0.98	0.98	0.98	0.98	0.98	0.98	0.98	0.98
Percent Heavy Veh, %	2	2	3	2	2	2	2	2	2	2	2	2
Cap, veh/h	325	185	155	221	127	108	170	1829		459	1860	
Arrive On Green	0.03	0.03	0.03	0.06	0.07	0.07	0.10	0.36	0.00	0.51	1.00	0.00
Sat Flow, veh/h	3456	1870	1572	3456	1870	1585	1781	5106	1585	1781	3554	1585
Grp Volume(v), veh/h	264	118	155	114	93	66	142	1103	0	51	1053	0
Grp Sat Flow(s),veh/h/ln	1728	1870	1572	1728	1870	1585	1781	1702	1585	1781	1777	1585
Q Serve(g_s), s	9.1	7.5	9.1	3.8	5.9	4.9	9.4	21.2	0.0	1.8	0.0	0.0
Cycle Q Clear(g_c), s	9.1	7.5	9.1	3.8	5.9	4.9	9.4	21.2	0.0	1.8	0.0	0.0
Prop In Lane	1.00		1.00	1.00		1.00	1.00		1.00	1.00		1.00
Lane Grp Cap(c), veh/h	325	185	155	221	127	108	170	1829		459	1860	
V/C Ratio(X)	0.81	0.64	1.00	0.52	0.73	0.61	0.83	0.60		0.11	0.57	
Avail Cap(c_a), veh/h	374	312	262	221	223	189	266	2442		459	1860	
HCM Platoon Ratio	0.33	0.33	0.33	1.00	1.00	1.00	1.00	1.00	1.00	2.00	2.00	2.00
Upstream Filter(I)	1.00	1.00	1.00	1.00	1.00	1.00	1.00	1.00	0.00	0.91	0.91	0.00
Uniform Delay (d), s/veh	57.1	55.9	34.7	54.4	54.9	54.4	53.3	31.5	0.0	22.0	0.0	0.0
Incr Delay (d2), s/veh	11.4	3.6	42.7	2.1	7.8	5.5	12.3	1.5	0.0	0.1	1.1	0.0
Initial Q Delay(d3), s/veh	0.0	0.0	0.0	0.0	0.0	0.0	0.0	0.0	0.0	0.0	0.0	0.0
%ile BackOfQ(95%),veh/ln	8.2	6.9	9.5	3.1	5.4	3.8	8.2	13.4	0.0	1.3	0.5	0.0
Unsig. Movement Delay, s/veh												
LnGrp Delay(d), s/veh	68.5	59.6	77.4	56.4	62.7	59.9	65.7	33.0	0.0	22.1	1.1	0.0
LnGrp LOS	E	E	E	E	E	E	E	C		C	A	
Approach Vol, veh/h		537			273			1245			1104	
Approach Delay, s/veh		69.1			59.4			36.7			2.1	
Approach LOS		E			E			D			A	
Timer - Assigned Phs	1	2	3	4	5	6	7	8				
Phs Duration (G+Y+Rc), s	36.9	49.5	14.8	18.9	17.6	68.8	18.4	15.3				
Change Period (Y+Rc), s	6.0	6.5	7.1	7.0	6.1	6.0	7.1	* 7.1				
Max Green Setting (Gmax), s	8.7	57.4	7.3	20.0	17.9	48.6	13.0	* 14				
Max Q Clear Time (g_c+I1), s	3.8	23.2	5.8	11.1	11.4	2.0	11.1	7.9				
Green Ext Time (p_c), s	0.0	19.8	0.0	0.7	0.2	23.1	0.2	0.3				
Intersection Summary												
HCM 7th Control Delay, s/veh			32.1									
HCM 7th LOS			C									
Notes												
User approved pedestrian interval to be less than phase max green.												
* HCM 7th computational engine requires equal clearance times for the phases crossing the barrier.												

Unsignalized Delay for [NBR, SBR] is excluded from calculations of the approach delay and intersection delay.

Intersection						
Int Delay, s/veh	0.3					
Movement	EBL	EBR	NBL	NBT	SBT	SBR
Lane Configurations		↗		↕	↕	
Traffic Vol, veh/h	0	26	0	321	607	0
Future Vol, veh/h	0	26	0	321	607	0
Conflicting Peds, #/hr	0	0	0	0	0	0
Sign Control	Stop	Stop	Free	Free	Free	Free
RT Channelized	-	None	-	None	-	None
Storage Length	-	0	-	-	-	-
Veh in Median Storage, #	0	-	-	0	0	-
Grade, %	0	-	-	0	0	-
Peak Hour Factor	98	98	98	98	98	98
Heavy Vehicles, %	2	2	2	2	2	2
Mvmt Flow	0	27	0	328	619	0

Major/Minor	Minor2	Major1	Major2		
Conflicting Flow All	-	619	-	0	-
Stage 1	-	-	-	-	-
Stage 2	-	-	-	-	-
Critical Hdwy	-	6.23	-	-	-
Critical Hdwy Stg 1	-	-	-	-	-
Critical Hdwy Stg 2	-	-	-	-	-
Follow-up Hdwy	-	3.319	-	-	-
Pot Cap-1 Maneuver	0	487	0	-	-
Stage 1	0	-	0	-	-
Stage 2	0	-	0	-	-
Platoon blocked, %				-	-
Mov Cap-1 Maneuver	-	487	-	-	-
Mov Cap-2 Maneuver	-	-	-	-	-
Stage 1	-	-	-	-	-
Stage 2	-	-	-	-	-

Approach	EB	NB	SB
HCM Control Delay, s/v	12.81	0	0
HCM LOS	B		

Minor Lane/Major Mvmt	NBT EBLn1	SBT
Capacity (veh/h)	- 487	-
HCM Lane V/C Ratio	- 0.054	-
HCM Control Delay (s/veh)	- 12.8	-
HCM Lane LOS	- B	-
HCM 95th %tile Q(veh)	- 0.2	-

Queues
7: Oldham Parkway & Access 2























Existing + Full Development Traffic Volumes
SAT Peak Hour



Lane Group	EBL	EBT	WBL	WBT	NBL	NBT	NBR	SBL	SBT
Lane Group Flow (vph)	21	125	334	25	137	159	32	5	202
v/c Ratio	0.03	0.15	0.59	0.03	0.38	0.28	0.06	0.01	0.36
Control Delay (s/veh)	6.6	3.0	13.3	5.9	16.2	13.4	6.0	12.0	13.9
Queue Delay	0.0	0.0	0.0	0.0	0.0	0.0	0.0	0.0	0.0
Total Delay (s/veh)	6.6	3.0	13.3	5.9	16.2	13.4	6.0	12.0	13.9
Queue Length 50th (ft)	2	2	44	2	21	23	0	1	30
Queue Length 95th (ft)	12	24	136	12	77	80	15	7	98
Internal Link Dist (ft)		202		215		382			316
Turn Bay Length (ft)					150			100	
Base Capacity (vph)	1380	1628	1261	1807	1068	1693	1442	1111	1666
Starvation Cap Reductn	0	0	0	0	0	0	0	0	0
Spillback Cap Reductn	0	0	0	0	0	0	0	0	0
Storage Cap Reductn	0	0	0	0	0	0	0	0	0
Reduced v/c Ratio	0.02	0.08	0.26	0.01	0.13	0.09	0.02	0.00	0.12
Intersection Summary									

HCM 7th Signalized Intersection Summary
7: Oldham Parkway & Access 2

Existing + Full Development Traffic Volumes
SAT Peak Hour

												
Movement	EBL	EBT	EBR	WBL	WBT	WBR	NBL	NBT	NBR	SBL	SBT	SBR
Lane Configurations												
Traffic Volume (veh/h)	21	20	103	327	20	5	134	156	31	5	177	21
Future Volume (veh/h)	21	20	103	327	20	5	134	156	31	5	177	21
Initial Q (Qb), veh	0	0	0	0	0	0	0	0	0	0	0	0
Lane Width Adj.	1.00	1.00	1.00	1.00	1.00	1.00	1.00	1.00	1.00	1.00	1.00	1.00
Ped-Bike Adj(A_pbT)	1.00		1.00	1.00		1.00	1.00		1.00	1.00		1.00
Parking Bus, Adj	1.00	1.00	1.00	1.00	1.00	1.00	1.00	1.00	1.00	1.00	1.00	1.00
Work Zone On Approach		No			No			No			No	
Adj Sat Flow, veh/h/ln	1870	1870	1870	1870	1870	1870	1870	1870	1870	1870	1870	1870
Adj Flow Rate, veh/h	21	20	105	334	20	5	137	159	0	5	181	21
Peak Hour Factor	0.98	0.98	0.98	0.98	0.98	0.98	0.98	0.98	0.98	0.98	0.98	0.98
Percent Heavy Veh, %	2	2	2	2	2	2	2	2	2	2	2	2
Cap, veh/h	775	102	537	676	568	142	499	569		536	501	58
Arrive On Green	0.39	0.39	0.39	0.39	0.39	0.39	0.30	0.30	0.00	0.30	0.30	0.30
Sat Flow, veh/h	1386	260	1365	1266	1444	361	1180	1870	1585	1227	1645	191
Grp Volume(v), veh/h	21	0	125	334	0	25	137	159	0	5	0	202
Grp Sat Flow(s),veh/h/ln	1386	0	1625	1266	0	1805	1180	1870	1585	1227	0	1836
Q Serve(g_s), s	0.3	0.0	1.5	7.0	0.0	0.3	3.1	1.9	0.0	0.1	0.0	2.6
Cycle Q Clear(g_c), s	0.5	0.0	1.5	8.5	0.0	0.3	5.6	1.9	0.0	2.0	0.0	2.6
Prop In Lane	1.00		0.84	1.00		0.20	1.00		1.00	1.00		0.10
Lane Grp Cap(c), veh/h	775	0	639	676	0	711	499	569		536	0	559
V/C Ratio(X)	0.03	0.00	0.20	0.49	0.00	0.04	0.27	0.28		0.01	0.00	0.36
Avail Cap(c_a), veh/h	3601	0	3952	3257	0	4392	1665	2416		1748	0	2372
HCM Platoon Ratio	1.00	1.00	1.00	1.00	1.00	1.00	1.00	1.00	1.00	1.00	1.00	1.00
Upstream Filter(I)	1.00	0.00	1.00	1.00	0.00	1.00	1.00	1.00	0.00	1.00	0.00	1.00
Uniform Delay (d), s/veh	5.7	0.0	5.9	8.7	0.0	5.6	10.3	7.9	0.0	8.6	0.0	8.1
Incr Delay (d2), s/veh	0.0	0.0	0.1	0.6	0.0	0.0	0.3	0.3	0.0	0.0	0.0	0.4
Initial Q Delay(d3), s/veh	0.0	0.0	0.0	0.0	0.0	0.0	0.0	0.0	0.0	0.0	0.0	0.0
%ile BackOfQ(95%),veh/ln	0.1	0.0	0.6	2.3	0.0	0.1	1.1	1.0	0.0	0.0	0.0	1.3
Unsig. Movement Delay, s/veh												
LnGrp Delay(d), s/veh	5.7	0.0	6.1	9.3	0.0	5.6	10.6	8.1	0.0	8.7	0.0	8.5
LnGrp LOS	A		A	A		A	B	A		A		A
Approach Vol, veh/h		146			359			296			207	
Approach Delay, s/veh		6.0			9.0			9.3			8.5	
Approach LOS		A			A			A			A	
Timer - Assigned Phs		2		4		6		8				
Phs Duration (G+Y+Rc), s		13.6		16.2		13.6		16.2				
Change Period (Y+Rc), s		4.5		4.5		4.5		4.5				
Max Green Setting (Gmax), s		38.5		72.5		38.5		72.5				
Max Q Clear Time (g_c+I1), s		7.6		3.5		4.6		10.5				
Green Ext Time (p_c), s		1.5		0.9		1.2		1.4				
Intersection Summary												
HCM 7th Control Delay, s/veh			8.6									
HCM 7th LOS			A									
Notes												
Unsignalized Delay for [NBR] is excluded from calculations of the approach delay and intersection delay.												

HCM 7th TWSC
8: Oldham Parkway & Access 3

Existing + Full Development Traffic Volumes
SAT Peak Hour

Intersection												
Int Delay, s/veh	3											
Movement	EBL	EBT	EBR	WBL	WBT	WBR	NBL	NBT	NBR	SBL	SBT	SBR
Lane Configurations		+			+		+	+			+	
Traffic Vol, veh/h	9	0	34	45	0	3	35	100	47	3	124	11
Future Vol, veh/h	9	0	34	45	0	3	35	100	47	3	124	11
Conflicting Peds, #/hr	0	0	0	0	0	0	0	0	0	0	0	0
Sign Control	Stop	Stop	Stop	Stop	Stop	Stop	Free	Free	Free	Free	Free	Free
RT Channelized	-	-	None	-	-	None	-	-	None	-	-	None
Storage Length	-	-	-	-	-	-	150	-	-	-	-	-
Veh in Median Storage, #	-	0	-	-	0	-	-	0	-	-	0	-
Grade, %	-	0	-	-	0	-	-	0	-	-	0	-
Peak Hour Factor	98	98	98	98	98	98	98	98	98	98	98	98
Heavy Vehicles, %	2	2	2	2	2	2	2	2	2	2	2	2
Mvmt Flow	9	0	35	46	0	3	36	102	48	3	127	11

Major/Minor	Minor2		Minor1		Major1			Major2				
Conflicting Flow All	312	360	132	330	341	126	138	0	0	150	0	0
Stage 1	138	138	-	197	197	-	-	-	-	-	-	-
Stage 2	173	221	-	133	144	-	-	-	-	-	-	-
Critical Hdwy	7.12	6.52	6.22	7.12	6.52	6.22	4.12	-	-	4.12	-	-
Critical Hdwy Stg 1	6.12	5.52	-	6.12	5.52	-	-	-	-	-	-	-
Critical Hdwy Stg 2	6.12	5.52	-	6.12	5.52	-	-	-	-	-	-	-
Follow-up Hdwy	3.518	4.018	3.318	3.518	4.018	3.318	2.218	-	-	2.218	-	-
Pot Cap-1 Maneuver	641	567	917	623	581	924	1446	-	-	1431	-	-
Stage 1	865	782	-	804	738	-	-	-	-	-	-	-
Stage 2	828	720	-	871	778	-	-	-	-	-	-	-
Platoon blocked, %								-	-	-	-	-
Mov Cap-1 Maneuver	621	552	917	583	565	924	1446	-	-	1431	-	-
Mov Cap-2 Maneuver	621	552	-	583	565	-	-	-	-	-	-	-
Stage 1	863	780	-	785	719	-	-	-	-	-	-	-
Stage 2	805	702	-	836	776	-	-	-	-	-	-	-

Approach	EB	WB	NB	SB
HCM Control Delay, s/v	9.56	11.57	1.45	0.16
HCM LOS	A	B		

Minor Lane/Major Mvmt	NBL	NBT	NBR	EBLn1WBLn1	SBL	SBT	SBR
Capacity (veh/h)	1446	-	-	834	597	39	-
HCM Lane V/C Ratio	0.025	-	-	0.053	0.082	0.002	-
HCM Control Delay (s/veh)	7.6	-	-	9.6	11.6	7.5	0
HCM Lane LOS	A	-	-	A	B	A	A
HCM 95th %tile Q(veh)	0.1	-	-	0.2	0.3	0	-

Intersection						
Int Delay, s/veh	0.5					
Movement	EBT	EBR	WBL	WBT	NBL	NBR
Lane Configurations	T			T	T	
Traffic Vol, veh/h	133	5	5	107	5	5
Future Vol, veh/h	133	5	5	107	5	5
Conflicting Peds, #/hr	0	0	0	0	0	0
Sign Control	Free	Free	Free	Free	Stop	Stop
RT Channelized	-	None	-	None	-	None
Storage Length	-	-	-	-	0	-
Veh in Median Storage, #	0	-	-	0	0	-
Grade, %	0	-	-	0	0	-
Peak Hour Factor	98	98	98	98	98	98
Heavy Vehicles, %	2	2	2	2	2	2
Mvmt Flow	136	5	5	109	5	5

Major/Minor	Major1	Major2	Minor1	Minor2	Minor3
Conflicting Flow All	0	0	141	0	258
Stage 1	-	-	-	-	138
Stage 2	-	-	-	-	119
Critical Hdwy	-	-	4.12	-	6.42
Critical Hdwy Stg 1	-	-	-	-	5.42
Critical Hdwy Stg 2	-	-	-	-	5.42
Follow-up Hdwy	-	-	2.218	-	3.518
Pot Cap-1 Maneuver	-	-	1442	-	731
Stage 1	-	-	-	-	888
Stage 2	-	-	-	-	906
Platoon blocked, %	-	-	-	-	-
Mov Cap-1 Maneuver	-	-	1442	-	728
Mov Cap-2 Maneuver	-	-	-	-	728
Stage 1	-	-	-	-	888
Stage 2	-	-	-	-	902

Approach	EB	WB	NB
HCM Control Delay, s/v	0	0.34	9.51
HCM LOS			A

Minor Lane/Major Mvmt	NBLn1	EBT	EBR	WBL	WBT
Capacity (veh/h)	809	-	-	80	-
HCM Lane V/C Ratio	0.013	-	-	0.004	-
HCM Control Delay (s/veh)	9.5	-	-	7.5	0
HCM Lane LOS	A	-	-	A	A
HCM 95th %tile Q(veh)	0	-	-	0	-

Intersection						
Int Delay, s/veh	0.5					
Movement	EBT	EBR	WBL	WBT	NBL	NBR
Lane Configurations	T			T	T	
Traffic Vol, veh/h	133	5	5	107	5	5
Future Vol, veh/h	133	5	5	107	5	5
Conflicting Peds, #/hr	0	0	0	0	0	0
Sign Control	Free	Free	Free	Free	Stop	Stop
RT Channelized	-	None	-	None	-	None
Storage Length	-	-	-	-	0	-
Veh in Median Storage, #	0	-	-	0	0	-
Grade, %	0	-	-	0	0	-
Peak Hour Factor	98	98	98	98	98	98
Heavy Vehicles, %	2	2	2	2	2	2
Mvmt Flow	136	5	5	109	5	5

Major/Minor	Major1	Major2	Minor1	Minor2	Minor3
Conflicting Flow All	0	0	141	0	258
Stage 1	-	-	-	-	138
Stage 2	-	-	-	-	119
Critical Hdwy	-	-	4.12	-	6.42
Critical Hdwy Stg 1	-	-	-	-	5.42
Critical Hdwy Stg 2	-	-	-	-	5.42
Follow-up Hdwy	-	-	2.218	-	3.518
Pot Cap-1 Maneuver	-	-	1442	-	731
Stage 1	-	-	-	-	888
Stage 2	-	-	-	-	906
Platoon blocked, %	-	-	-	-	-
Mov Cap-1 Maneuver	-	-	1442	-	728
Mov Cap-2 Maneuver	-	-	-	-	728
Stage 1	-	-	-	-	888
Stage 2	-	-	-	-	902

Approach	EB	WB	NB
HCM Control Delay, s/v	0	0.34	9.51
HCM LOS			A

Minor Lane/Major Mvmt	NBLn1	EBT	EBR	WBL	WBT
Capacity (veh/h)	809	-	-	80	-
HCM Lane V/C Ratio	0.013	-	-	0.004	-
HCM Control Delay (s/veh)	9.5	-	-	7.5	0
HCM Lane LOS	A	-	-	A	A
HCM 95th %tile Q(veh)	0	-	-	0	-

Intersection						
Int Delay, s/veh	5.1					
Movement	WBL	WBR	NBT	NBR	SBL	SBT
Lane Configurations	↘		↗		↘	↗
Traffic Vol, veh/h	182	24	137	25	25	142
Future Vol, veh/h	182	24	137	25	25	142
Conflicting Peds, #/hr	0	0	0	0	0	0
Sign Control	Stop	Stop	Free	Free	Free	Free
RT Channelized	-	None	-	None	-	None
Storage Length	0	-	-	-	100	-
Veh in Median Storage, #	0	-	0	-	-	0
Grade, %	0	-	0	-	-	0
Peak Hour Factor	98	98	98	98	98	98
Heavy Vehicles, %	2	2	2	2	2	2
Mvmt Flow	186	24	140	26	26	145

Major/Minor	Minor1	Major1	Major2		
Conflicting Flow All	348	153	0	0	165
Stage 1	153	-	-	-	-
Stage 2	196	-	-	-	-
Critical Hdwy	6.42	6.22	-	-	4.12
Critical Hdwy Stg 1	5.42	-	-	-	-
Critical Hdwy Stg 2	5.42	-	-	-	-
Follow-up Hdwy	3.518	3.318	-	-	2.218
Pot Cap-1 Maneuver	649	894	-	-	1413
Stage 1	875	-	-	-	-
Stage 2	837	-	-	-	-
Platoon blocked, %			-	-	-
Mov Cap-1 Maneuver	637	894	-	-	1413
Mov Cap-2 Maneuver	676	-	-	-	-
Stage 1	875	-	-	-	-
Stage 2	822	-	-	-	-

Approach	WB	NB	SB
HCM Control Delay, s/v12.39		0	1.14
HCM LOS	B		

Minor Lane/Major Mvmt	NBT	NBRWBLn1	SBL	SBT
Capacity (veh/h)	-	-	696	1413
HCM Lane V/C Ratio	-	-	0.302	0.018
HCM Control Delay (s/veh)	-	-	12.4	7.6
HCM Lane LOS	-	-	B	A
HCM 95th %tile Q(veh)	-	-	1.3	0.1

Intersection						
Int Delay, s/veh	1.9					
Movement	WBL	WBR	NBT	NBR	SBL	SBT
Lane Configurations	↘		↗		↘	↗
Traffic Vol, veh/h	24	28	136	25	29	143
Future Vol, veh/h	24	28	136	25	29	143
Conflicting Peds, #/hr	0	0	0	0	0	0
Sign Control	Stop	Stop	Free	Free	Free	Free
RT Channelized	-	None	-	None	-	None
Storage Length	-	-	-	-	100	-
Veh in Median Storage, #	0	-	0	-	-	0
Grade, %	0	-	0	-	-	0
Peak Hour Factor	98	98	98	98	98	98
Heavy Vehicles, %	2	2	2	2	2	2
Mvmt Flow	24	29	139	26	30	146

Major/Minor	Minor1	Major1	Major2		
Conflicting Flow All	357	152	0	0	164
Stage 1	152	-	-	-	-
Stage 2	205	-	-	-	-
Critical Hdwy	6.42	6.22	-	-	4.12
Critical Hdwy Stg 1	5.42	-	-	-	-
Critical Hdwy Stg 2	5.42	-	-	-	-
Follow-up Hdwy	3.518	3.318	-	-	2.218
Pot Cap-1 Maneuver	642	895	-	-	1414
Stage 1	876	-	-	-	-
Stage 2	829	-	-	-	-
Platoon blocked, %			-	-	-
Mov Cap-1 Maneuver	628	895	-	-	1414
Mov Cap-2 Maneuver	670	-	-	-	-
Stage 1	876	-	-	-	-
Stage 2	812	-	-	-	-

Approach	WB	NB	SB
HCM Control Delay, s/v	9.99	0	1.28
HCM LOS	A		

Minor Lane/Major Mvmt	NBT	NBRWBLn1	SBL	SBT
Capacity (veh/h)	-	-	775	1414
HCM Lane V/C Ratio	-	-	0.068	0.021
HCM Control Delay (s/veh)	-	-	10	7.6
HCM Lane LOS	-	-	A	A
HCM 95th %tile Q(veh)	-	-	0.2	0.1

HCM 7th TWSC
 13: Jefferson Street & Access 6

Existing + Full Development Traffic Volumes
 SAT Peak Hour

Intersection												
Int Delay, s/veh	5.2											
Movement	EBL	EBT	EBR	WBL	WBT	WBR	NBL	NBT	NBR	SBL	SBT	SBR
Lane Configurations		+			+		+	+		+	+	
Traffic Vol, veh/h	48	0	24	36	0	85	25	102	37	86	112	50
Future Vol, veh/h	48	0	24	36	0	85	25	102	37	86	112	50
Conflicting Peds, #/hr	0	0	0	0	0	0	0	0	0	0	0	0
Sign Control	Stop	Stop	Stop	Stop	Stop	Stop	Free	Free	Free	Free	Free	Free
RT Channelized	-	-	None	-	-	None	-	-	None	-	-	None
Storage Length	-	-	-	-	-	-	100	-	-	100	-	-
Veh in Median Storage, #	-	0	-	-	0	-	-	0	-	-	0	-
Grade, %	-	0	-	-	0	-	-	0	-	-	0	-
Peak Hour Factor	98	98	98	98	98	98	98	98	98	98	98	98
Heavy Vehicles, %	2	2	2	2	2	2	2	2	2	2	2	2
Mvmt Flow	49	0	24	37	0	87	26	104	38	88	114	51

Major/Minor	Minor2		Minor1		Major1		Major2					
Conflicting Flow All	470	508	140	464	515	123	165	0	0	142	0	0
Stage 1	315	315	-	174	174	-	-	-	-	-	-	-
Stage 2	155	193	-	290	341	-	-	-	-	-	-	-
Critical Hdwy	7.12	6.52	6.22	7.12	6.52	6.22	4.12	-	-	4.12	-	-
Critical Hdwy Stg 1	6.12	5.52	-	6.12	5.52	-	-	-	-	-	-	-
Critical Hdwy Stg 2	6.12	5.52	-	6.12	5.52	-	-	-	-	-	-	-
Follow-up Hdwy	3.518	4.018	3.318	3.518	4.018	3.318	2.218	-	-	2.218	-	-
Pot Cap-1 Maneuver	503	468	908	509	464	928	1413	-	-	1441	-	-
Stage 1	696	655	-	828	755	-	-	-	-	-	-	-
Stage 2	847	741	-	718	639	-	-	-	-	-	-	-
Platoon blocked, %								-	-	-	-	-
Mov Cap-1 Maneuver	421	431	908	456	428	928	1413	-	-	1441	-	-
Mov Cap-2 Maneuver	421	431	-	456	428	-	-	-	-	-	-	-
Stage 1	653	615	-	813	741	-	-	-	-	-	-	-
Stage 2	754	728	-	656	600	-	-	-	-	-	-	-

Approach	EB		WB		NB		SB	
HCM Control Delay, s/v	13.2		11.14		1.16		2.66	
HCM LOS	B		B					

Minor Lane/Major Mvmt	NBL	NBT	NBR	EBLn1WBLn1	SBL	SBT	SBR
Capacity (veh/h)	1413	-	-	513	710	1441	-
HCM Lane V/C Ratio	0.018	-	-	0.143	0.174	0.061	-
HCM Control Delay (s/veh)	7.6	-	-	13.2	11.1	7.7	-
HCM Lane LOS	A	-	-	B	B	A	-
HCM 95th %tile Q(veh)	0.1	-	-	0.5	0.6	0.2	-

Intersection						
Int Delay, s/veh	2.1					
Movement	WBL	WBR	NBT	NBR	SBL	SBT
Lane Configurations	↘		↗		↘	↗
Traffic Vol, veh/h	28	28	206	29	74	220
Future Vol, veh/h	28	28	206	29	74	220
Conflicting Peds, #/hr	0	0	0	0	0	0
Sign Control	Stop	Stop	Free	Free	Free	Free
RT Channelized	-	None	-	None	-	None
Storage Length	0	-	-	-	100	-
Veh in Median Storage, #	0	-	0	-	-	0
Grade, %	0	-	0	-	-	0
Peak Hour Factor	98	98	98	98	98	98
Heavy Vehicles, %	2	2	2	2	2	2
Mvmt Flow	29	29	210	30	76	224

Major/Minor	Minor1	Major1	Major2		
Conflicting Flow All	601	225	0	0	240
Stage 1	225	-	-	-	-
Stage 2	376	-	-	-	-
Critical Hdwy	6.42	6.22	-	-	4.12
Critical Hdwy Stg 1	5.42	-	-	-	-
Critical Hdwy Stg 2	5.42	-	-	-	-
Follow-up Hdwy	3.518	3.318	-	-	2.218
Pot Cap-1 Maneuver	464	814	-	-	1327
Stage 1	812	-	-	-	-
Stage 2	695	-	-	-	-
Platoon blocked, %			-	-	-
Mov Cap-1 Maneuver	437	814	-	-	1327
Mov Cap-2 Maneuver	525	-	-	-	-
Stage 1	812	-	-	-	-
Stage 2	655	-	-	-	-

Approach	WB	NB	SB
HCM Control Delay, s/v	11.19	0	1.98
HCM LOS	B		

Minor Lane/Major Mvmt	NBT	NBRWBLn1	SBL	SBT
Capacity (veh/h)	-	-	638	1327
HCM Lane V/C Ratio	-	-	0.09	0.057
HCM Control Delay (s/veh)	-	-	11.2	7.9
HCM Lane LOS	-	-	B	A
HCM 95th %tile Q(veh)	-	-	0.3	0.2

HCM Unsignalized Intersection Capacity Analysis Existing + Full Development Traffic Volumes
 15: Access 8 & Oldham Parkway SAT Peak Hour



Movement	EBT	EBR	WBL	WBT	NBL	NBR	
Lane Configurations	↑↑↑↑			↑↑		↗	
Traffic Volume (veh/h)	829	12	0	898	0	56	
Future Volume (Veh/h)	829	12	0	898	0	56	
Sign Control	Free			Free	Stop		
Grade	0%			0%	0%		
Peak Hour Factor	0.98	0.98	0.98	0.98	0.98	0.98	
Hourly flow rate (vph)	846	12	0	916	0	57	
Pedestrians							
Lane Width (ft)							
Walking Speed (ft/s)							
Percent Blockage							
Right turn flare (veh)							
Median type	None			None			
Median storage (veh)							
Upstream signal (ft)	1111			281			
pX, platoon unblocked							
vC, conflicting volume			858	1310	218		
vC1, stage 1 conf vol							
vC2, stage 2 conf vol							
vCu, unblocked vol			858	1310	218		
tC, single (s)			4.1	6.8	6.9		
tC, 2 stage (s)							
tF (s)			2.2	3.5	3.3		
p0 queue free %			100	100	93		
cM capacity (veh/h)			779	151	787		
Direction, Lane #	EB 1	EB 2	EB 3	EB 4	WB 1	WB 2	NB 1
Volume Total	242	242	242	133	458	458	57
Volume Left	0	0	0	0	0	0	0
Volume Right	0	0	0	12	0	0	57
cSH	1700	1700	1700	1700	1700	1700	787
Volume to Capacity	0.14	0.14	0.14	0.08	0.27	0.27	0.07
Queue Length 95th (ft)	0	0	0	0	0	0	6
Control Delay (s/veh)	0.0	0.0	0.0	0.0	0.0	0.0	9.9
Lane LOS							A
Approach Delay (s/veh)	0.0			0.0			9.9
Approach LOS							A
Intersection Summary							
Average Delay			0.3				
Intersection Capacity Utilization			28.2%		ICU Level of Service		A
Analysis Period (min)			15				

Queues
1: Ward Road & Oldham Parkway

Future Conditions Traffic Volumes
AM Peak Hour



Lane Group	EBL	EBT	WBT	NBL	NBT	SBL	SBT	SBR
Lane Group Flow (vph)	45	36	273	17	749	201	302	74
v/c Ratio	0.30	0.10	0.68	0.10	0.62	0.56	0.14	0.07
Control Delay (s/veh)	33.9	19.9	27.1	40.3	23.3	35.8	9.6	3.0
Queue Delay	0.0	0.0	0.0	0.0	0.0	0.0	0.0	0.0
Total Delay (s/veh)	33.9	19.9	27.1	40.3	23.3	35.8	9.6	3.0
Queue Length 50th (ft)	17	7	64	7	136	78	24	0
Queue Length 95th (ft)	57	37	183	33	268	190	78	20
Internal Link Dist (ft)		116	246		459		353	
Turn Bay Length (ft)				110		105		
Base Capacity (vph)	344	803	782	373	2345	686	2857	1293
Starvation Cap Reductn	0	0	0	0	0	0	0	0
Spillback Cap Reductn	0	0	0	0	0	0	0	0
Storage Cap Reductn	0	0	0	0	0	0	0	0
Reduced v/c Ratio	0.13	0.04	0.35	0.05	0.32	0.29	0.11	0.06

Intersection Summary

HCM 7th Signalized Intersection Summary
1: Ward Road & Oldham Parkway

Future Conditions Traffic Volumes
AM Peak Hour



Movement	EBL	EBT	EBR	WBL	WBT	WBR	NBL	NBT	NBR	SBL	SBT	SBR
Lane Configurations												
Traffic Volume (veh/h)	44	21	15	38	35	194	17	692	42	197	296	73
Future Volume (veh/h)	44	21	15	38	35	194	17	692	42	197	296	73
Initial Q (Qb), veh	0	0	0	0	0	0	0	0	0	0	0	0
Lane Width Adj.	1.00	1.00	1.00	1.00	1.00	1.00	1.00	1.00	1.00	1.00	1.00	1.00
Ped-Bike Adj(A_pbT)	1.00		1.00	1.00		1.00	1.00		1.00	1.00		1.00
Parking Bus, Adj	1.00	1.00	1.00	1.00	1.00	1.00	1.00	1.00	1.00	1.00	1.00	1.00
Work Zone On Approach		No			No			No			No	
Adj Sat Flow, veh/h/ln	1870	1870	1870	1870	1870	1870	1870	1870	1870	1870	1870	1870
Adj Flow Rate, veh/h	45	21	15	39	36	198	17	706	43	201	302	74
Peak Hour Factor	0.98	0.98	0.98	0.98	0.98	0.98	0.98	0.98	0.98	0.98	0.98	0.98
Percent Heavy Veh, %	2	2	2	2	2	2	2	2	2	2	2	2
Cap, veh/h	322	222	159	102	65	255	37	1143	70	259	1638	730
Arrive On Green	0.22	0.22	0.22	0.22	0.22	0.22	0.02	0.34	0.34	0.15	0.46	0.46
Sat Flow, veh/h	1146	1015	725	143	299	1167	1781	3403	207	1781	3554	1585
Grp Volume(v), veh/h	45	0	36	273	0	0	17	368	381	201	302	74
Grp Sat Flow(s),veh/h/ln	1146	0	1740	1609	0	0	1781	1777	1833	1781	1777	1585
Q Serve(g_s), s	0.0	0.0	1.0	4.5	0.0	0.0	0.6	10.1	10.2	6.3	2.9	1.5
Cycle Q Clear(g_c), s	2.7	0.0	1.0	9.3	0.0	0.0	0.6	10.1	10.2	6.3	2.9	1.5
Prop In Lane	1.00		0.42	0.14		0.73	1.00		0.11	1.00		1.00
Lane Grp Cap(c), veh/h	322	0	381	422	0	0	37	597	616	259	1638	730
V/C Ratio(X)	0.14	0.00	0.09	0.65	0.00	0.00	0.46	0.62	0.62	0.78	0.18	0.10
Avail Cap(c_a), veh/h	678	0	921	913	0	0	436	1379	1422	802	3488	1556
HCM Platoon Ratio	1.00	1.00	1.00	1.00	1.00	1.00	1.00	1.00	1.00	1.00	1.00	1.00
Upstream Filter(I)	1.00	0.00	1.00	1.00	0.00	0.00	1.00	1.00	1.00	1.00	1.00	1.00
Uniform Delay (d), s/veh	18.9	0.0	18.2	21.4	0.0	0.0	28.3	16.2	16.3	24.0	9.3	8.9
Incr Delay (d2), s/veh	0.2	0.0	0.1	1.7	0.0	0.0	8.8	1.5	1.4	4.9	0.1	0.1
Initial Q Delay(d3), s/veh	0.0	0.0	0.0	0.0	0.0	0.0	0.0	0.0	0.0	0.0	0.0	0.0
%ile BackOfQ(95%),veh/ln	0.9	0.0	0.7	6.0	0.0	0.0	0.6	6.9	7.1	5.0	1.7	0.8
Unsig. Movement Delay, s/veh												
LnGrp Delay(d), s/veh	19.0	0.0	18.3	23.0	0.0	0.0	37.1	17.7	17.7	28.9	9.4	9.0
LnGrp LOS	B		B	C			D	B	B	C	A	A
Approach Vol, veh/h		81			273			766			577	
Approach Delay, s/veh		18.7			23.0			18.1			16.1	
Approach LOS		B			C			B			B	
Timer - Assigned Phs	1	2		4	5	6		8				
Phs Duration (G+Y+Rc), s	6.9	32.6		18.9	14.2	25.3		18.9				
Change Period (Y+Rc), s	5.7	5.7		6.1	5.7	5.7		6.1				
Max Green Setting (Gmax), s	14.3	57.3		30.9	26.3	45.3		30.9				
Max Q Clear Time (g_c+I1), s	2.6	4.9		11.3	8.3	12.2		4.7				
Green Ext Time (p_c), s	0.0	3.4		1.6	0.5	7.5		0.3				
Intersection Summary												
HCM 7th Control Delay, s/veh			18.3									
HCM 7th LOS			B									
Notes												
User approved pedestrian interval to be less than phase max green.												

HCM 7th TWSC
2: Jefferson Street & Oldham Parkway

Future Conditions Traffic Volumes
AM Peak Hour

Intersection												
Int Delay, s/veh	4.6											
Movement	EBL	EBT	EBR	WBL	WBT	WBR	NBL	NBT	NBR	SBL	SBT	SBR
Lane Configurations	↗	↗↘		↗	↗↘				↗			↗
Traffic Vol, veh/h	3	547	56	437	443	323	0	0	306	0	0	2
Future Vol, veh/h	3	547	56	437	443	323	0	0	306	0	0	2
Conflicting Peds, #/hr	0	0	0	0	0	0	0	0	0	0	0	0
Sign Control	Free	Free	Free	Free	Free	Free	Stop	Stop	Stop	Stop	Stop	Stop
RT Channelized	-	-	None	-	-	None	-	-	None	-	-	None
Storage Length	150	-	-	400	-	-	-	-	0	-	-	0
Veh in Median Storage, #	-	0	-	-	0	-	-	0	-	-	0	-
Grade, %	-	0	-	-	0	-	-	0	-	-	0	-
Peak Hour Factor	98	98	98	98	98	98	98	98	98	98	98	98
Heavy Vehicles, %	2	2	2	2	2	2	2	2	2	2	2	2
Mvmt Flow	3	558	57	446	452	330	0	0	312	0	0	2













Major/Minor	Major1			Major2			Minor1			Minor2		
Conflicting Flow All	782	0	0	615	0	0	-	-	308	-	-	391
Stage 1	-	-	-	-	-	-	-	-	-	-	-	-
Stage 2	-	-	-	-	-	-	-	-	-	-	-	-
Critical Hdwy	4.14	-	-	4.14	-	-	-	-	6.94	-	-	6.94
Critical Hdwy Stg 1	-	-	-	-	-	-	-	-	-	-	-	-
Critical Hdwy Stg 2	-	-	-	-	-	-	-	-	-	-	-	-
Follow-up Hdwy	2.22	-	-	2.22	-	-	-	-	3.32	-	-	3.32
Pot Cap-1 Maneuver	832	-	-	960	-	-	0	0	688	0	0	608
Stage 1	-	-	-	-	-	-	0	0	-	0	0	-
Stage 2	-	-	-	-	-	-	0	0	-	0	0	-
Platoon blocked, %		-	-	-	-	-						
Mov Cap-1 Maneuver	832	-	-	960	-	-	-	-	688	-	-	608
Mov Cap-2 Maneuver	-	-	-	-	-	-	-	-	-	-	-	-
Stage 1	-	-	-	-	-	-	-	-	-	-	-	-
Stage 2	-	-	-	-	-	-	-	-	-	-	-	-

Approach	EB			WB			NB			SB		
HCM Control Delay, s/v	0.05			4.34			14.5			10.94		
HCM LOS							B			B		

Minor Lane/Major Mvmt	NBLn1	EBL	EBT	EBR	WBL	WBT	WBR	SBLn1
Capacity (veh/h)	688	832	-	-	960	-	-	608
HCM Lane V/C Ratio	0.454	0.004	-	-	0.464	-	-	0.003
HCM Control Delay (s/veh)	14.5	9.3	-	-	12	-	-	10.9
HCM Lane LOS	B	A	-	-	B	-	-	B
HCM 95th %tile Q(veh)	2.4	0	-	-	2.5	-	-	0

Queues
3: M-291 & Oldham Parkway

Future Conditions Traffic Volumes
AM Peak Hour

												
Lane Group	EBL	EBT	EBR	WBL	WBT	WBR	NBL	NBT	NBR	SBL	SBT	SBR
Lane Group Flow (vph)	638	5	270	31	5	41	329	1954	51	46	1565	848
v/c Ratio	0.87	0.01	0.45	0.21	0.04	0.11	0.80	0.76	0.05	0.30	0.76	0.80
Control Delay (s/veh)	59.8	35.2	7.0	59.2	54.4	0.6	41.8	9.6	0.0	61.0	35.4	13.6
Queue Delay	0.0	0.0	0.0	0.0	0.0	0.0	0.0	0.0	0.0	0.0	0.0	0.0
Total Delay (s/veh)	59.8	35.2	7.0	59.2	54.4	0.6	41.8	9.6	0.0	61.0	35.4	13.6
Queue Length 50th (ft)	244	3	0	12	4	0	129	149	0	18	405	105
Queue Length 95th (ft)	#321	14	68	28	17	0	m157	226	m0	38	469	333
Internal Link Dist (ft)		201			629			1398			887	
Turn Bay Length (ft)	345						250		365	300		300
Base Capacity (vph)	766	475	604	146	108	366	423	2550	908	153	2040	1048
Starvation Cap Reductn	0	0	0	0	0	0	0	0	0	0	0	0
Spillback Cap Reductn	0	0	0	0	0	0	0	0	0	0	0	0
Storage Cap Reductn	0	0	0	0	0	0	0	0	0	0	0	0
Reduced v/c Ratio	0.83	0.01	0.45	0.21	0.05	0.11	0.78	0.77	0.06	0.30	0.77	0.81































Intersection Summary

95th percentile volume exceeds capacity, queue may be longer.
Queue shown is maximum after two cycles.

m Volume for 95th percentile queue is metered by upstream signal.

HCM 7th Signalized Intersection Summary
3: M-291 & Oldham Parkway

Future Conditions Traffic Volumes
AM Peak Hour

												
Movement	EBL	EBT	EBR	WBL	WBT	WBR	NBL	NBT	NBR	SBL	SBT	SBR
Lane Configurations	 		 	 			 	  		  		
Traffic Volume (veh/h)	625	5	265	30	5	40	322	1915	50	45	1534	831
Future Volume (veh/h)	625	5	265	30	5	40	322	1915	50	45	1534	831
Initial Q (Qb), veh	0	0	0	0	0	0	0	0	0	0	0	0
Lane Width Adj.	1.00	1.00	1.00	1.00	1.00	1.00	1.00	1.00	1.00	1.00	1.00	1.00
Ped-Bike Adj(A_pbT)	1.00		1.00	1.00		1.00	1.00		1.00	1.00		1.00
Parking Bus, Adj	1.00	1.00	1.00	1.00	1.00	1.00	1.00	1.00	1.00	1.00	1.00	1.00
Work Zone On Approach		No			No			No			No	
Adj Sat Flow, veh/h/ln	1870	1870	1870	1870	1870	1870	1870	1870	1870	1870	1870	1870
Adj Flow Rate, veh/h	638	5	0	31	5	41	329	1954	0	46	1565	0
Peak Hour Factor	0.98	0.98	0.98	0.98	0.98	0.98	0.98	0.98	0.98	0.98	0.98	0.98
Percent Heavy Veh, %	2	2	2	2	2	2	2	2	2	2	2	2
Cap, veh/h	705	432		93	102	86	540	2423		113	1796	
Arrive On Green	0.20	0.23	0.00	0.03	0.05	0.05	0.31	0.95	0.00	0.03	0.35	0.00
Sat Flow, veh/h	3456	1870	1585	3456	1870	1585	3456	5106	1585	3456	5106	1585
Grp Volume(v), veh/h	638	5	0	31	5	41	329	1954	0	46	1565	0
Grp Sat Flow(s),veh/h/ln	1728	1870	1585	1728	1870	1585	1728	1702	1585	1728	1702	1585
Q Serve(g_s), s	21.6	0.2	0.0	1.1	0.3	3.0	9.7	10.0	0.0	1.6	34.4	0.0
Cycle Q Clear(g_c), s	21.6	0.2	0.0	1.1	0.3	3.0	9.7	10.0	0.0	1.6	34.4	0.0
Prop In Lane	1.00		1.00	1.00		1.00	1.00		1.00	1.00		1.00
Lane Grp Cap(c), veh/h	705	432		93	102	86	540	2423		113	1796	
V/C Ratio(X)	0.90	0.01		0.33	0.05	0.47	0.61	0.81		0.41	0.87	
Avail Cap(c_a), veh/h	772	444		144	109	92	540	2423		144	1855	
HCM Platoon Ratio	1.00	1.00	1.00	1.00	1.00	1.00	2.00	2.00	2.00	1.00	1.00	1.00
Upstream Filter(I)	1.00	1.00	0.00	1.00	1.00	1.00	0.53	0.53	0.00	1.00	1.00	0.00
Uniform Delay (d), s/veh	46.6	35.6	0.0	57.3	53.8	55.1	38.1	1.9	0.0	56.9	36.4	0.0
Incr Delay (d2), s/veh	13.4	0.0	0.0	2.1	0.2	4.0	1.1	1.6	0.0	2.3	6.1	0.0
Initial Q Delay(d3), s/veh	0.0	0.0	0.0	0.0	0.0	0.0	0.0	0.0	0.0	0.0	0.0	0.0
%ile BackOfQ(95%),veh/ln	16.0	0.2	0.0	0.9	0.3	2.4	5.9	2.3	0.0	1.3	20.9	0.0
Unsig. Movement Delay, s/veh												
LnGrp Delay(d), s/veh	60.0	35.6	0.0	59.4	54.0	59.0	39.2	3.5	0.0	59.2	42.5	0.0
LnGrp LOS	E	D		E	D	E	D	A		E	D	
Approach Vol, veh/h		643			77			2283			1611	
Approach Delay, s/veh		59.8			58.9			8.6			43.0	
Approach LOS		E			E			A			D	
Timer - Assigned Phs	1	2	3	4	5	6	7	8				
Phs Duration (G+Y+Rc), s	10.6	64.1	10.5	34.7	25.9	48.8	31.7	13.5				
Change Period (Y+Rc), s	6.7	* 7.2	7.3	7.0	7.2	6.6	7.2	* 7				
Max Green Setting (Gmax), s	5.0	* 54	5.0	28.5	14.8	43.6	26.8	* 7				
Max Q Clear Time (g_c+I1), s	3.6	12.0	3.1	2.2	11.7	36.4	23.6	5.0				
Green Ext Time (p_c), s	0.0	28.4	0.0	0.0	0.4	5.8	0.9	0.0				
Intersection Summary												
HCM 7th Control Delay, s/veh			28.6									
HCM 7th LOS			C									
Notes												
User approved pedestrian interval to be less than phase max green.												
* HCM 7th computational engine requires equal clearance times for the phases crossing the barrier.												

Unsignalized Delay for [NBR, EBR, SBR] is excluded from calculations of the approach delay and intersection delay.

Queues
4: Jefferson Street & Persels Road

Future Conditions Traffic Volumes
AM Peak Hour























Lane Group	EBL	EBT	WBL	WBT	WBR	NBL	NBT	SBL	SBT
Lane Group Flow (vph)	65	351	364	295	65	19	321	219	336
v/c Ratio	0.14	0.27	0.60	0.36	0.08	0.05	0.77	0.65	0.56
Control Delay (s/veh)	18.5	29.6	31.2	25.8	3.0	20.8	41.7	34.9	35.8
Queue Delay	0.0	0.0	0.0	0.0	0.0	0.0	0.0	0.0	0.0
Total Delay (s/veh)	18.5	29.6	31.2	25.8	3.0	20.8	41.7	34.9	35.8
Queue Length 50th (ft)	23	96	198	151	0	9	158	119	187
Queue Length 95th (ft)	56	171	305	327	m8	21	242	154	293
Internal Link Dist (ft)		1272		101			1173		315
Turn Bay Length (ft)	110		175			110		150	
Base Capacity (vph)	463	1334	699	844	777	343	524	334	601
Starvation Cap Reductn	0	0	0	0	0	0	0	0	0
Spillback Cap Reductn	0	0	0	0	0	0	0	0	0
Storage Cap Reductn	0	0	0	0	0	0	0	0	0
Reduced v/c Ratio	0.14	0.26	0.52	0.35	0.08	0.06	0.61	0.66	0.56

Intersection Summary

m Volume for 95th percentile queue is metered by upstream signal.

HCM 7th Signalized Intersection Summary
4: Jefferson Street & Persels Road

Future Conditions Traffic Volumes
AM Peak Hour

												
Movement	EBL	EBT	EBR	WBL	WBT	WBR	NBL	NBT	NBR	SBL	SBT	SBR
Lane Configurations												
Traffic Volume (veh/h)	64	303	41	357	289	64	19	84	230	215	245	84
Future Volume (veh/h)	64	303	41	357	289	64	19	84	230	215	245	84
Initial Q (Qb), veh	0	0	0	0	0	0	0	0	0	0	0	0
Lane Width Adj.	1.00	1.00	1.00	1.00	1.00	1.00	1.00	1.00	1.00	1.00	1.00	1.00
Ped-Bike Adj(A_pbT)	1.00		1.00	1.00		1.00	1.00		1.00	1.00		1.00
Parking Bus, Adj	1.00	1.00	1.00	1.00	1.00	1.00	1.00	1.00	1.00	1.00	1.00	1.00
Work Zone On Approach		No			No			No			No	
Adj Sat Flow, veh/h/ln	1870	1870	1870	1870	1870	1870	1870	1870	1870	1870	1870	1870
Adj Flow Rate, veh/h	65	309	42	364	295	65	19	86	235	219	250	86
Peak Hour Factor	0.98	0.98	0.98	0.98	0.98	0.98	0.98	0.98	0.98	0.98	0.98	0.98
Percent Heavy Veh, %	2	2	2	2	2	2	2	2	2	2	2	2
Cap, veh/h	615	441	59	740	362	307	260	97	266	287	385	132
Arrive On Green	0.31	0.14	0.14	0.61	0.32	0.32	0.04	0.22	0.22	0.11	0.29	0.29
Sat Flow, veh/h	1781	3147	424	1781	1870	1585	1781	443	1210	1781	1330	458
Grp Volume(v), veh/h	65	173	178	364	295	65	19	0	321	219	0	336
Grp Sat Flow(s),veh/h/ln	1781	1777	1794	1781	1870	1585	1781	0	1653	1781	0	1788
Q Serve(g_s), s	0.0	11.1	11.4	5.4	17.4	3.0	1.0	0.0	22.6	11.0	0.0	19.7
Cycle Q Clear(g_c), s	0.0	11.1	11.4	5.4	17.4	3.0	1.0	0.0	22.6	11.0	0.0	19.7
Prop In Lane	1.00		0.24	1.00		1.00	1.00		0.73	1.00		0.26
Lane Grp Cap(c), veh/h	615	249	251	740	362	307	260	0	364	287	0	517
V/C Ratio(X)	0.11	0.70	0.71	0.49	0.82	0.21	0.07	0.00	0.88	0.76	0.00	0.65
Avail Cap(c_a), veh/h	615	489	493	740	701	594	339	0	441	287	0	521
HCM Platoon Ratio	1.00	1.00	1.00	1.67	1.67	1.67	1.00	1.00	1.00	1.00	1.00	1.00
Upstream Filter(I)	1.00	1.00	1.00	1.00	1.00	1.00	1.00	0.00	1.00	1.00	0.00	1.00
Uniform Delay (d), s/veh	28.4	49.2	49.2	15.1	38.7	24.4	33.8	0.0	45.3	32.4	0.0	37.3
Incr Delay (d2), s/veh	0.1	14.9	15.5	0.7	18.1	1.6	0.2	0.0	19.3	12.2	0.0	3.9
Initial Q Delay(d3), s/veh	0.0	0.0	0.0	0.0	0.0	0.0	0.0	0.0	0.0	0.0	0.0	0.0
%ile BackOfQ(95%),veh/ln	2.4	9.9	10.2	7.8	13.6	2.6	0.8	0.0	16.5	9.5	0.0	14.0
Unsig. Movement Delay, s/veh												
LnGrp Delay(d), s/veh	28.5	64.1	64.7	15.9	56.7	26.0	34.0	0.0	64.6	44.6	0.0	41.2
LnGrp LOS	C	E	E	B	E	C	C		E	D		D
Approach Vol, veh/h		416			724			340				555
Approach Delay, s/veh		58.8			33.4			62.9				42.5
Approach LOS		E			C			E				D
Timer - Assigned Phs	1	2	3	4	5	6	7	8				
Phs Duration (G+Y+Rc), s	48.8	21.8	18.0	31.4	42.4	28.2	9.7	39.7				
Change Period (Y+Rc), s	5.0	5.0	5.0	5.0	5.0	5.0	5.0	5.0				
Max Green Setting (Gmax), s	22.0	33.0	13.0	32.0	10.0	45.0	10.0	35.0				
Max Q Clear Time (g_c+I1), s	7.4	13.4	13.0	24.6	2.0	19.4	3.0	21.7				
Green Ext Time (p_c), s	1.6	3.5	0.0	1.9	0.1	3.8	0.0	2.8				
Intersection Summary												
HCM 7th Control Delay, s/veh			46.0									
HCM 7th LOS			D									

Queues
5: M-291 & Persels Road/Bailey Road

Future Conditions Traffic Volumes
AM Peak Hour



























Lane Group	EBL	EBT	EBR	WBL	WBT	WBR	NBL	NBT	NBR	SBL	SBT	SBR
Lane Group Flow (vph)	464	148	150	267	194	93	168	1873	407	108	1260	595
v/c Ratio	0.82	0.48	0.46	0.49	0.68	0.29	0.54	0.79	0.42	0.44	0.55	0.60
Control Delay (s/veh)	52.9	51.6	10.4	49.6	66.5	2.3	58.7	30.9	3.3	31.9	6.3	3.5
Queue Delay	0.0	0.0	0.0	0.0	0.0	0.0	0.0	0.0	0.0	0.0	0.0	0.0
Total Delay (s/veh)	52.9	51.6	10.4	49.6	66.5	2.3	58.7	30.9	3.3	31.9	6.3	3.5
Queue Length 50th (ft)	190	45	6	96	77	0	64	452	0	39	50	14
Queue Length 95th (ft)	190	m85	m45	144	118	0	101	519	56	m51	75	40
Internal Link Dist (ft)		341			1421			2289			1398	
Turn Bay Length (ft)	200		150	280		290	310		350	330		
Base Capacity (vph)	600	457	381	543	291	319	357	2353	951	243	2271	983
Starvation Cap Reductn	0	0	0	0	0	0	0	0	0	0	0	0
Spillback Cap Reductn	0	0	0	0	0	0	0	0	0	0	0	0
Storage Cap Reductn	0	0	0	0	0	0	0	0	0	0	0	0
Reduced v/c Ratio	0.77	0.32	0.39	0.49	0.67	0.29	0.47	0.80	0.43	0.44	0.55	0.61

Intersection Summary

m Volume for 95th percentile queue is metered by upstream signal.

HCM 7th Signalized Intersection Summary
5: M-291 & Persels Road/Bailey Road

Future Conditions Traffic Volumes
AM Peak Hour

												
Movement	EBL	EBT	EBR	WBL	WBT	WBR	NBL	NBT	NBR	SBL	SBT	SBR
Lane Configurations												
Traffic Volume (veh/h)	455	145	147	262	190	91	165	1836	399	106	1235	583
Future Volume (veh/h)	455	145	147	262	190	91	165	1836	399	106	1235	583
Initial Q (Qb), veh	0	0	0	0	0	0	0	0	0	0	0	0
Lane Width Adj.	1.00	1.00	1.00	1.00	1.00	1.00	1.00	1.00	1.00	1.00	1.00	1.00
Ped-Bike Adj(A_pbT)	1.00		1.00	1.00		1.00	1.00		1.00	1.00		1.00
Parking Bus, Adj	1.00	1.00	1.00	1.00	1.00	1.00	1.00	1.00	1.00	1.00	1.00	1.00
Work Zone On Approach		No			No			No			No	
Adj Sat Flow, veh/h/ln	1870	1870	1856	1870	1870	1870	1870	1870	1870	1870	1870	1870
Adj Flow Rate, veh/h	464	148	150	267	194	93	168	1873	0	108	1260	0
Peak Hour Factor	0.98	0.98	0.98	0.98	0.98	0.98	0.98	0.98	0.98	0.98	0.98	0.98
Percent Heavy Veh, %	2	2	3	2	2	2	2	2	2	2	2	2
Cap, veh/h	534	348	154	460	268	120	227	2265		359	2476	
Arrive On Green	0.05	0.03	0.03	0.13	0.08	0.08	0.07	0.44	0.00	0.21	0.97	0.00
Sat Flow, veh/h	3456	3554	1572	3456	3554	1585	3456	5106	1585	3456	5106	1585
Grp Volume(v), veh/h	464	148	150	267	194	93	168	1873	0	108	1260	0
Grp Sat Flow(s),veh/h/ln	1728	1777	1572	1728	1777	1585	1728	1702	1585	1728	1702	1585
Q Serve(g_s), s	16.0	4.9	9.2	8.7	6.4	6.9	5.7	38.7	0.0	3.2	1.8	0.0
Cycle Q Clear(g_c), s	16.0	4.9	9.2	8.7	6.4	6.9	5.7	38.7	0.0	3.2	1.8	0.0
Prop In Lane	1.00		1.00	1.00		1.00	1.00		1.00	1.00		1.00
Lane Grp Cap(c), veh/h	534	348	154	460	268	120	227	2265		359	2476	
V/C Ratio(X)	0.87	0.43	0.98	0.58	0.72	0.78	0.74	0.83		0.30	0.51	
Avail Cap(c_a), veh/h	605	459	203	460	293	131	360	2298		359	2476	
HCM Platoon Ratio	0.33	0.33	0.33	1.00	1.00	1.00	1.00	1.00	1.00	2.00	2.00	2.00
Upstream Filter(I)	1.00	1.00	1.00	1.00	1.00	1.00	1.00	1.00	0.00	0.63	0.63	0.00
Uniform Delay (d), s/veh	55.7	54.8	37.6	48.9	54.2	54.5	55.0	29.3	0.0	43.9	1.0	0.0
Incr Delay (d2), s/veh	11.8	0.8	49.7	1.8	7.7	23.3	4.7	3.6	0.0	0.3	0.5	0.0
Initial Q Delay(d3), s/veh	0.0	0.0	0.0	0.0	0.0	0.0	0.0	0.0	0.0	0.0	0.0	0.0
%ile BackOfQ(95%),veh/ln	13.0	4.1	9.9	6.9	5.6	6.3	4.6	22.0	0.0	2.3	0.8	0.0
Unsig. Movement Delay, s/veh												
LnGrp Delay(d), s/veh	67.5	55.6	87.4	50.7	62.0	77.8	59.7	33.0	0.0	44.2	1.4	0.0
LnGrp LOS	E	E	F	D	E	E	E	C		D	A	
Approach Vol, veh/h		762			554			2041			1368	
Approach Delay, s/veh		69.1			59.2			35.2			4.8	
Approach LOS		E			E			D			A	
Timer - Assigned Phs	1	2	3	4	5	6	7	8				
Phs Duration (G+Y+Rc), s	18.5	59.7	23.1	18.7	14.0	64.2	25.6	16.2				
Change Period (Y+Rc), s	6.0	6.5	7.1	7.0	6.1	6.0	7.1	* 7.1				
Max Green Setting (Gmax), s	8.5	54.0	15.4	15.5	12.5	50.4	21.0	* 9.9				
Max Q Clear Time (g_c+I1), s	5.2	40.7	10.7	11.2	7.7	3.8	18.0	8.9				
Green Ext Time (p_c), s	0.1	12.6	0.4	0.5	0.2	27.6	0.5	0.1				
Intersection Summary												
HCM 7th Control Delay, s/veh			34.7									
HCM 7th LOS			C									
Notes												
User approved pedestrian interval to be less than phase max green.												
* HCM 7th computational engine requires equal clearance times for the phases crossing the barrier.												

Unsignalized Delay for [NBR, SBR] is excluded from calculations of the approach delay and intersection delay.

Intersection						
Int Delay, s/veh	0.2					
Movement	EBL	EBR	NBL	NBT	SBT	SBR
Lane Configurations		↗		↕	↕	
Traffic Vol, veh/h	0	21	0	445	586	0
Future Vol, veh/h	0	21	0	445	586	0
Conflicting Peds, #/hr	0	0	0	0	0	0
Sign Control	Stop	Stop	Free	Free	Free	Free
RT Channelized	-	None	-	None	-	None
Storage Length	-	0	-	-	-	-
Veh in Median Storage, #	0	-	-	0	0	-
Grade, %	0	-	-	0	0	-
Peak Hour Factor	98	98	98	98	98	98
Heavy Vehicles, %	2	2	2	2	2	2
Mvmt Flow	0	21	0	454	598	0

Major/Minor	Minor2	Major1	Major2			
Conflicting Flow All	-	598	-	0	-	0
Stage 1	-	-	-	-	-	-
Stage 2	-	-	-	-	-	-
Critical Hdwy	-	6.23	-	-	-	-
Critical Hdwy Stg 1	-	-	-	-	-	-
Critical Hdwy Stg 2	-	-	-	-	-	-
Follow-up Hdwy	-	3.319	-	-	-	-
Pot Cap-1 Maneuver	0	501	0	-	-	0
Stage 1	0	-	0	-	-	0
Stage 2	0	-	0	-	-	0
Platoon blocked, %				-	-	
Mov Cap-1 Maneuver	-	501	-	-	-	-
Mov Cap-2 Maneuver	-	-	-	-	-	-
Stage 1	-	-	-	-	-	-
Stage 2	-	-	-	-	-	-

Approach	EB	NB	SB
HCM Control Delay, s/v	12.5	0	0
HCM LOS	B		

Minor Lane/Major Mvmt	NBT EBLn1	SBT
Capacity (veh/h)	- 501	-
HCM Lane V/C Ratio	- 0.043	-
HCM Control Delay (s/veh)	- 12.5	-
HCM Lane LOS	- B	-
HCM 95th %tile Q(veh)	- 0.1	-

Queues
7: Oldham Parkway & Access 2























Future Conditions Traffic Volumes
AM Peak Hour



Lane Group	EBL	EBT	WBL	WBT	NBL	NBT	NBR	SBL	SBT
Lane Group Flow (vph)	17	106	307	24	135	287	33	5	226
v/c Ratio	0.02	0.14	0.56	0.03	0.35	0.46	0.05	0.01	0.36
Control Delay (s/veh)	7.4	3.5	13.8	6.7	14.3	14.1	5.3	10.8	12.7
Queue Delay	0.0	0.0	0.0	0.0	0.0	0.0	0.0	0.0	0.0
Total Delay (s/veh)	7.4	3.5	13.8	6.7	14.3	14.1	5.3	10.8	12.7
Queue Length 50th (ft)	2	2	41	2	19	43	0	1	32
Queue Length 95th (ft)	11	23	126	13	70	128	14	7	100
Internal Link Dist (ft)		202		215		382			357
Turn Bay Length (ft)					150			150	
Base Capacity (vph)	1382	1635	1283	1816	1095	1775	1510	1012	1751
Starvation Cap Reductn	0	0	0	0	0	0	0	0	0
Spillback Cap Reductn	0	0	0	0	0	0	0	0	0
Storage Cap Reductn	0	0	0	0	0	0	0	0	0
Reduced v/c Ratio	0.01	0.06	0.24	0.01	0.12	0.16	0.02	0.00	0.13
Intersection Summary									

HCM 7th Signalized Intersection Summary
7: Oldham Parkway & Access 2

Future Conditions Traffic Volumes
AM Peak Hour

												
Movement	EBL	EBT	EBR	WBL	WBT	WBR	NBL	NBT	NBR	SBL	SBT	SBR
Lane Configurations												
Traffic Volume (veh/h)	17	20	84	301	20	4	132	281	32	5	201	21
Future Volume (veh/h)	17	20	84	301	20	4	132	281	32	5	201	21
Initial Q (Qb), veh	0	0	0	0	0	0	0	0	0	0	0	0
Lane Width Adj.	1.00	1.00	1.00	1.00	1.00	1.00	1.00	1.00	1.00	1.00	1.00	1.00
Ped-Bike Adj(A_pbT)	1.00		1.00	1.00		1.00	1.00		1.00	1.00		1.00
Parking Bus, Adj	1.00	1.00	1.00	1.00	1.00	1.00	1.00	1.00	1.00	1.00	1.00	1.00
Work Zone On Approach		No			No			No			No	
Adj Sat Flow, veh/h/ln	1870	1870	1870	1870	1870	1870	1870	1870	1870	1870	1870	1870
Adj Flow Rate, veh/h	17	20	86	307	20	4	135	287	0	5	205	21
Peak Hour Factor	0.98	0.98	0.98	0.98	0.98	0.98	0.98	0.98	0.98	0.98	0.98	0.98
Percent Heavy Veh, %	2	2	2	2	2	2	2	2	2	2	2	2
Cap, veh/h	727	111	475	646	543	109	526	635		481	566	58
Arrive On Green	0.36	0.36	0.36	0.36	0.36	0.36	0.34	0.34	0.00	0.34	0.34	0.34
Sat Flow, veh/h	1387	308	1324	1288	1513	303	1155	1870	1585	1092	1669	171
Grp Volume(v), veh/h	17	0	106	307	0	24	135	287	0	5	0	226
Grp Sat Flow(s),veh/h/ln	1387	0	1632	1288	0	1816	1155	1870	1585	1092	0	1840
Q Serve(g_s), s	0.2	0.0	1.3	6.4	0.0	0.3	3.0	3.6	0.0	0.1	0.0	2.8
Cycle Q Clear(g_c), s	0.5	0.0	1.3	7.7	0.0	0.3	5.7	3.6	0.0	3.7	0.0	2.8
Prop In Lane	1.00		0.81	1.00		0.17	1.00		1.00	1.00		0.09
Lane Grp Cap(c), veh/h	727	0	586	646	0	652	526	635		481	0	624
V/C Ratio(X)	0.02	0.00	0.18	0.48	0.00	0.04	0.26	0.45		0.01	0.00	0.36
Avail Cap(c_a), veh/h	3368	0	3692	3098	0	4108	1818	2727		1703	0	2682
HCM Platoon Ratio	1.00	1.00	1.00	1.00	1.00	1.00	1.00	1.00	1.00	1.00	1.00	1.00
Upstream Filter(I)	1.00	0.00	1.00	1.00	0.00	1.00	1.00	1.00	0.00	1.00	0.00	1.00
Uniform Delay (d), s/veh	6.4	0.0	6.6	9.2	0.0	6.2	9.6	7.7	0.0	9.1	0.0	7.4
Incr Delay (d2), s/veh	0.0	0.0	0.1	0.5	0.0	0.0	0.3	0.5	0.0	0.0	0.0	0.4
Initial Q Delay(d3), s/veh	0.0	0.0	0.0	0.0	0.0	0.0	0.0	0.0	0.0	0.0	0.0	0.0
%ile BackOfQ(95%),veh/ln	0.1	0.0	0.5	2.2	0.0	0.1	1.0	1.8	0.0	0.0	0.0	1.3
Unsig. Movement Delay, s/veh												
LnGrp Delay(d), s/veh	6.4	0.0	6.7	9.7	0.0	6.2	9.8	8.2	0.0	9.1	0.0	7.8
LnGrp LOS	A		A	A		A	A	A		A		A
Approach Vol, veh/h		123			331			422			231	
Approach Delay, s/veh		6.7			9.5			8.7			7.8	
Approach LOS		A			A			A			A	
Timer - Assigned Phs		2		4		6		8				
Phs Duration (G+Y+Rc), s		14.6		15.2		14.6		15.2				
Change Period (Y+Rc), s		4.5		4.5		4.5		4.5				
Max Green Setting (Gmax), s		43.5		67.5		43.5		67.5				
Max Q Clear Time (g_c+I1), s		7.7		3.3		5.7		9.7				
Green Ext Time (p_c), s		2.4		0.8		1.4		1.2				
Intersection Summary												
HCM 7th Control Delay, s/veh			8.5									
HCM 7th LOS			A									
Notes												
Unsignalized Delay for [NBR] is excluded from calculations of the approach delay and intersection delay.												

HCM 7th TWSC
8: Oldham Parkway & Access 3

Future Conditions Traffic Volumes
AM Peak Hour

Intersection												
Int Delay, s/veh	2.3											
Movement	EBL	EBT	EBR	WBL	WBT	WBR	NBL	NBT	NBR	SBL	SBT	SBR
Lane Configurations		+			+		↑	↓			+	
Traffic Vol, veh/h	8	0	32	39	0	2	37	218	47	3	156	11
Future Vol, veh/h	8	0	32	39	0	2	37	218	47	3	156	11
Conflicting Peds, #/hr	0	0	0	0	0	0	0	0	0	0	0	0
Sign Control	Stop	Stop	Stop	Stop	Stop	Stop	Free	Free	Free	Free	Free	Free
RT Channelized	-	-	None	-	-	None	-	-	None	-	-	None
Storage Length	-	-	-	-	-	-	150	-	-	-	-	-
Veh in Median Storage, #	-	0	-	-	0	-	-	0	-	-	0	-
Grade, %	-	0	-	-	0	-	-	0	-	-	0	-
Peak Hour Factor	98	98	98	98	98	98	98	98	98	98	98	98
Heavy Vehicles, %	2	2	2	2	2	2	2	2	2	2	2	2
Mvmt Flow	8	0	33	40	0	2	38	222	48	3	159	11

Major/Minor	Minor2		Minor1		Major1		Major2					
Conflicting Flow All	469	517	165	487	498	246	170	0	0	270	0	0
Stage 1	171	171	-	322	322	-	-	-	-	-	-	-
Stage 2	298	346	-	165	177	-	-	-	-	-	-	-
Critical Hdwy	7.12	6.52	6.22	7.12	6.52	6.22	4.12	-	-	4.12	-	-
Critical Hdwy Stg 1	6.12	5.52	-	6.12	5.52	-	-	-	-	-	-	-
Critical Hdwy Stg 2	6.12	5.52	-	6.12	5.52	-	-	-	-	-	-	-
Follow-up Hdwy	3.518	4.018	3.318	3.518	4.018	3.318	2.218	-	-	2.218	-	-
Pot Cap-1 Maneuver	505	462	880	491	474	792	1407	-	-	1293	-	-
Stage 1	831	757	-	690	651	-	-	-	-	-	-	-
Stage 2	711	635	-	837	753	-	-	-	-	-	-	-
Platoon blocked, %								-	-	-	-	-
Mov Cap-1 Maneuver	489	449	880	459	460	792	1407	-	-	1293	-	-
Mov Cap-2 Maneuver	489	449	-	459	460	-	-	-	-	-	-	-
Stage 1	829	755	-	671	634	-	-	-	-	-	-	-
Stage 2	690	618	-	804	751	-	-	-	-	-	-	-

Approach	EB		WB		NB		SB	
HCM Control Delay, s/v10.02			13.44		0.93		0.14	
HCM LOS	B		B					

Minor Lane/Major Mvmt	NBL	NBT	NBR	EBLn1WBLn1	SBL	SBT	SBR
Capacity (veh/h)	1407	-	-	758	468	31	-
HCM Lane V/C Ratio	0.027	-	-	0.054	0.089	0.002	-
HCM Control Delay (s/veh)	7.6	-	-	10	13.4	7.8	0
HCM Lane LOS	A	-	-	B	B	A	A
HCM 95th %tile Q(veh)	0.1	-	-	0.2	0.3	0	-

Intersection						
Int Delay, s/veh	0.3					
Movement	EBT	EBR	WBL	WBT	NBL	NBR
Lane Configurations	h			4	Y	
Traffic Vol, veh/h	165	5	5	223	4	5
Future Vol, veh/h	165	5	5	223	4	5
Conflicting Peds, #/hr	0	0	0	0	0	0
Sign Control	Free	Free	Free	Free	Stop	Stop
RT Channelized	-	None	-	None	-	None
Storage Length	-	-	-	-	0	-
Veh in Median Storage, #	0	-	-	0	0	-
Grade, %	0	-	-	0	0	-
Peak Hour Factor	98	98	98	98	98	98
Heavy Vehicles, %	2	2	2	2	2	2
Mvmt Flow	168	5	5	228	4	5

Major/Minor	Major1	Major2	Minor1		
Conflicting Flow All	0	0	173	0	409
Stage 1	-	-	-	-	171
Stage 2	-	-	-	-	238
Critical Hdwy	-	-	4.12	-	6.42
Critical Hdwy Stg 1	-	-	-	-	5.42
Critical Hdwy Stg 2	-	-	-	-	5.42
Follow-up Hdwy	-	-	2.218	-	3.518
Pot Cap-1 Maneuver	-	-	1403	-	599
Stage 1	-	-	-	-	859
Stage 2	-	-	-	-	802
Platoon blocked, %	-	-	-	-	-
Mov Cap-1 Maneuver	-	-	1403	-	596
Mov Cap-2 Maneuver	-	-	-	-	596
Stage 1	-	-	-	-	859
Stage 2	-	-	-	-	798

Approach	EB	WB	NB
HCM Control Delay, s/v	0	0.17	10.04
HCM LOS			B

Minor Lane/Major Mvmt	NBLn1	EBT	EBR	WBL	WBT
Capacity (veh/h)	724	-	-	39	-
HCM Lane V/C Ratio	0.013	-	-	0.004	-
HCM Control Delay (s/veh)	10	-	-	7.6	0
HCM Lane LOS	B	-	-	A	A
HCM 95th %tile Q(veh)	0	-	-	0	-

Intersection						
Int Delay, s/veh	0.3					
Movement	EBT	EBR	WBL	WBT	NBL	NBR
Lane Configurations	T			T	T	
Traffic Vol, veh/h	161	5	5	217	4	4
Future Vol, veh/h	161	5	5	217	4	4
Conflicting Peds, #/hr	0	0	0	0	0	0
Sign Control	Free	Free	Free	Free	Stop	Stop
RT Channelized	-	None	-	None	-	None
Storage Length	-	-	-	-	0	-
Veh in Median Storage, #	0	-	-	0	0	-
Grade, %	0	-	-	0	0	-
Peak Hour Factor	98	98	98	98	98	98
Heavy Vehicles, %	2	2	2	2	2	2
Mvmt Flow	164	5	5	221	4	4

Major/Minor	Major1	Major2	Minor1	Minor2	Minor3
Conflicting Flow All	0	0	169	0	398
Stage 1	-	-	-	-	167
Stage 2	-	-	-	-	232
Critical Hdwy	-	-	4.12	-	6.42
Critical Hdwy Stg 1	-	-	-	-	5.42
Critical Hdwy Stg 2	-	-	-	-	5.42
Follow-up Hdwy	-	-	2.218	-	3.518
Pot Cap-1 Maneuver	-	-	1408	-	607
Stage 1	-	-	-	-	863
Stage 2	-	-	-	-	807
Platoon blocked, %	-	-	-	-	-
Mov Cap-1 Maneuver	-	-	1408	-	605
Mov Cap-2 Maneuver	-	-	-	-	605
Stage 1	-	-	-	-	863
Stage 2	-	-	-	-	803

Approach	EB	WB	NB
HCM Control Delay, s/v	0	0.17	10.09
HCM LOS			B

Minor Lane/Major Mvmt	NBLn1	EBT	EBR	WBL	WBT
Capacity (veh/h)	716	-	-	41	-
HCM Lane V/C Ratio	0.011	-	-	0.004	-
HCM Control Delay (s/veh)	10.1	-	-	7.6	0
HCM Lane LOS	B	-	-	A	A
HCM 95th %tile Q(veh)	0	-	-	0	-

Intersection						
Int Delay, s/veh	4					
Movement	WBL	WBR	NBT	NBR	SBL	SBT
Lane Configurations	↘		↗		↘	↗
Traffic Vol, veh/h	179	21	192	19	19	366
Future Vol, veh/h	179	21	192	19	19	366
Conflicting Peds, #/hr	0	0	0	0	0	0
Sign Control	Stop	Stop	Free	Free	Free	Free
RT Channelized	-	None	-	None	-	None
Storage Length	0	-	-	-	100	-
Veh in Median Storage, #	0	-	0	-	-	0
Grade, %	0	-	0	-	-	0
Peak Hour Factor	98	98	98	98	98	98
Heavy Vehicles, %	2	2	2	2	2	2
Mvmt Flow	183	21	196	19	19	373

Major/Minor	Minor1	Major1	Major2		
Conflicting Flow All	618	206	0	0	215
Stage 1	206	-	-	-	-
Stage 2	412	-	-	-	-
Critical Hdwy	6.42	6.22	-	-	4.12
Critical Hdwy Stg 1	5.42	-	-	-	-
Critical Hdwy Stg 2	5.42	-	-	-	-
Follow-up Hdwy	3.518	3.318	-	-	2.218
Pot Cap-1 Maneuver	453	835	-	-	1355
Stage 1	829	-	-	-	-
Stage 2	668	-	-	-	-
Platoon blocked, %			-	-	-
Mov Cap-1 Maneuver	446	835	-	-	1355
Mov Cap-2 Maneuver	532	-	-	-	-
Stage 1	829	-	-	-	-
Stage 2	659	-	-	-	-

Approach	WB	NB	SB
HCM Control Delay, s/v15.26		0	0.38
HCM LOS	C		

Minor Lane/Major Mvmt	NBT	NBRWBLn1	SBL	SBT
Capacity (veh/h)	-	-	553	1355
HCM Lane V/C Ratio	-	-	0.369	0.014
HCM Control Delay (s/veh)	-	-	15.3	7.7
HCM Lane LOS	-	-	C	A
HCM 95th %tile Q(veh)	-	-	1.7	0

Intersection						
Int Delay, s/veh	1.1					
Movement	WBL	WBR	NBT	NBR	SBL	SBT
Lane Configurations	↘		↗		↘	↗
Traffic Vol, veh/h	22	27	194	19	25	363
Future Vol, veh/h	22	27	194	19	25	363
Conflicting Peds, #/hr	0	0	0	0	0	0
Sign Control	Stop	Stop	Free	Free	Free	Free
RT Channelized	-	None	-	None	-	None
Storage Length	-	-	-	-	100	-
Veh in Median Storage, #	0	-	0	-	-	0
Grade, %	0	-	0	-	-	0
Peak Hour Factor	98	98	98	98	98	98
Heavy Vehicles, %	2	2	2	2	2	2
Mvmt Flow	22	28	198	19	26	370

Major/Minor	Minor1	Major1	Major2		
Conflicting Flow All	629	208	0	0	217
Stage 1	208	-	-	-	-
Stage 2	421	-	-	-	-
Critical Hdwy	6.42	6.22	-	-	4.12
Critical Hdwy Stg 1	5.42	-	-	-	-
Critical Hdwy Stg 2	5.42	-	-	-	-
Follow-up Hdwy	3.518	3.318	-	-	2.218
Pot Cap-1 Maneuver	446	833	-	-	1352
Stage 1	827	-	-	-	-
Stage 2	662	-	-	-	-
Platoon blocked, %			-	-	-
Mov Cap-1 Maneuver	438	833	-	-	1352
Mov Cap-2 Maneuver	525	-	-	-	-
Stage 1	827	-	-	-	-
Stage 2	649	-	-	-	-

Approach	WB	NB	SB
HCM Control Delay, s/v10.91		0	0.5
HCM LOS	B		

Minor Lane/Major Mvmt	NBT	NBRWBLn1	SBL	SBT
Capacity (veh/h)	-	-	659	1352
HCM Lane V/C Ratio	-	-	0.076	0.019
HCM Control Delay (s/veh)	-	-	10.9	7.7
HCM Lane LOS	-	-	B	A
HCM 95th %tile Q(veh)	-	-	0.2	0.1

HCM 7th TWSC
13: Jefferson Street & Access 6

Future Conditions Traffic Volumes
AM Peak Hour

Intersection												
Int Delay, s/veh	4.1											
Movement	EBL	EBT	EBR	WBL	WBT	WBR	NBL	NBT	NBR	SBL	SBT	SBR
Lane Configurations		+			+		+	+		+	+	
Traffic Vol, veh/h	44	0	23	37	0	82	19	166	36	74	328	39
Future Vol, veh/h	44	0	23	37	0	82	19	166	36	74	328	39
Conflicting Peds, #/hr	0	0	0	0	0	0	0	0	0	0	0	0
Sign Control	Stop	Stop	Stop	Stop	Stop	Stop	Free	Free	Free	Free	Free	Free
RT Channelized	-	-	None	-	-	None	-	-	None	-	-	None
Storage Length	-	-	-	-	-	-	100	-	-	100	-	-
Veh in Median Storage, #	-	0	-	-	0	-	-	0	-	-	0	-
Grade, %	-	0	-	-	0	-	-	0	-	-	0	-
Peak Hour Factor	98	98	98	98	98	98	98	98	98	98	98	98
Heavy Vehicles, %	2	2	2	2	2	2	2	2	2	2	2	2
Mvmt Flow	45	0	23	38	0	84	19	169	37	76	335	40

Major/Minor	Minor2		Minor1		Major1		Major2					
Conflicting Flow All	714	751	355	712	752	188	374	0	0	206	0	0
Stage 1	506	506	-	227	227	-	-	-	-	-	-	-
Stage 2	208	245	-	486	526	-	-	-	-	-	-	-
Critical Hdwy	7.12	6.52	6.22	7.12	6.52	6.22	4.12	-	-	4.12	-	-
Critical Hdwy Stg 1	6.12	5.52	-	6.12	5.52	-	-	-	-	-	-	-
Critical Hdwy Stg 2	6.12	5.52	-	6.12	5.52	-	-	-	-	-	-	-
Follow-up Hdwy	3.518	4.018	3.318	3.518	4.018	3.318	2.218	-	-	2.218	-	-
Pot Cap-1 Maneuver	346	340	689	347	339	854	1184	-	-	1365	-	-
Stage 1	549	540	-	776	716	-	-	-	-	-	-	-
Stage 2	794	703	-	563	529	-	-	-	-	-	-	-
Platoon blocked, %								-	-	-	-	-
Mov Cap-1 Maneuver	290	316	689	312	315	854	1184	-	-	1365	-	-
Mov Cap-2 Maneuver	290	316	-	312	315	-	-	-	-	-	-	-
Stage 1	519	510	-	763	705	-	-	-	-	-	-	-
Stage 2	704	692	-	514	500	-	-	-	-	-	-	-

Approach	EB		WB		NB		SB	
HCM Control Delay, s/v	17.23		13.31		0.7		1.31	
HCM LOS	C		B					

Minor Lane/Major Mvmt	NBL	NBT	NBR	EBLn1WBLn1	SBL	SBT	SBR
Capacity (veh/h)	1184	-	-	362	554	1365	-
HCM Lane V/C Ratio	0.016	-	-	0.189	0.219	0.055	-
HCM Control Delay (s/veh)	8.1	-	-	17.2	13.3	7.8	-
HCM Lane LOS	A	-	-	C	B	A	-
HCM 95th %tile Q(veh)	0	-	-	0.7	0.8	0.2	-

Intersection						
Int Delay, s/veh	1.4					
Movement	WBL	WBR	NBT	NBR	SBL	SBT
Lane Configurations	↘		↗		↘	↗
Traffic Vol, veh/h	27	26	268	24	65	414
Future Vol, veh/h	27	26	268	24	65	414
Conflicting Peds, #/hr	0	0	0	0	0	0
Sign Control	Stop	Stop	Free	Free	Free	Free
RT Channelized	-	None	-	None	-	None
Storage Length	0	-	-	-	100	-
Veh in Median Storage, #	0	-	0	-	-	0
Grade, %	0	-	0	-	-	0
Peak Hour Factor	98	98	98	98	98	98
Heavy Vehicles, %	2	2	2	2	2	2
Mvmt Flow	28	27	273	24	66	422

Major/Minor	Minor1	Major1	Major2		
Conflicting Flow All	841	286	0	0	298
Stage 1	286	-	-	-	-
Stage 2	555	-	-	-	-
Critical Hdwy	6.42	6.22	-	-	4.12
Critical Hdwy Stg 1	5.42	-	-	-	-
Critical Hdwy Stg 2	5.42	-	-	-	-
Follow-up Hdwy	3.518	3.318	-	-	2.218
Pot Cap-1 Maneuver	335	753	-	-	1263
Stage 1	763	-	-	-	-
Stage 2	575	-	-	-	-
Platoon blocked, %			-	-	-
Mov Cap-1 Maneuver	317	753	-	-	1263
Mov Cap-2 Maneuver	427	-	-	-	-
Stage 1	763	-	-	-	-
Stage 2	545	-	-	-	-

Approach	WB	NB	SB
HCM Control Delay, s/v12.37		0	1.09
HCM LOS	B		

Minor Lane/Major Mvmt	NBT	NBRWBLn1	SBL	SBT
Capacity (veh/h)	-	-	542	1263
HCM Lane V/C Ratio	-	-	0.1	0.053
HCM Control Delay (s/veh)	-	-	12.4	8
HCM Lane LOS	-	-	B	A
HCM 95th %tile Q(veh)	-	-	0.3	0.2

HCM Unsignalized Intersection Capacity Analysis
 15: Access 8 & Oldham Parkway

Future Conditions Traffic Volumes
 AM Peak Hour



Movement	EBT	EBR	WBL	WBT	NBL	NBR	
Lane Configurations	↑↑↑↑			↑↑		↗	
Traffic Volume (veh/h)	838	10	0	1199	0	55	
Future Volume (Veh/h)	838	10	0	1199	0	55	
Sign Control	Free			Free	Stop		
Grade	0%			0%	0%		
Peak Hour Factor	0.98	0.98	0.98	0.98	0.98	0.98	
Hourly flow rate (vph)	855	10	0	1223	0	56	
Pedestrians							
Lane Width (ft)							
Walking Speed (ft/s)							
Percent Blockage							
Right turn flare (veh)							
Median type	None			None			
Median storage (veh)							
Upstream signal (ft)	1111			281			
pX, platoon unblocked							
vC, conflicting volume			865	1472	219		
vC1, stage 1 conf vol							
vC2, stage 2 conf vol							
vCu, unblocked vol			865	1472	219		
tC, single (s)			4.1	6.8	6.9		
tC, 2 stage (s)							
tF (s)			2.2	3.5	3.3		
p0 queue free %			100	100	93		
cM capacity (veh/h)			774	118	785		
Direction, Lane #	EB 1	EB 2	EB 3	EB 4	WB 1	WB 2	NB 1
Volume Total	244	244	244	132	612	612	56
Volume Left	0	0	0	0	0	0	0
Volume Right	0	0	0	10	0	0	56
cSH	1700	1700	1700	1700	1700	1700	785
Volume to Capacity	0.14	0.14	0.14	0.08	0.36	0.36	0.07
Queue Length 95th (ft)	0	0	0	0	0	0	6
Control Delay (s/veh)	0.0	0.0	0.0	0.0	0.0	0.0	9.9
Lane LOS							A
Approach Delay (s/veh)	0.0			0.0			9.9
Approach LOS							A
Intersection Summary							
Average Delay			0.3				
Intersection Capacity Utilization			36.5%	ICU Level of Service		A	
Analysis Period (min)			15				

Queues
1: Ward Road & Oldham Parkway

Future Conditions Traffic Volumes
PM Peak Hour



Lane Group	EBL	EBT	WBT	NBL	NBT	SBL	SBT	SBR
Lane Group Flow (vph)	169	87	260	37	709	187	709	232
v/c Ratio	0.70	0.18	0.53	0.21	0.63	0.58	0.41	0.26
Control Delay (s/veh)	45.6	13.9	21.0	44.1	27.2	41.4	16.9	3.4
Queue Delay	0.0	0.0	0.0	0.0	0.0	0.0	0.0	0.0
Total Delay (s/veh)	45.6	13.9	21.0	44.1	27.2	41.4	16.9	3.4
Queue Length 50th (ft)	73	13	65	17	148	82	126	0
Queue Length 95th (ft)	182	57	173	61	292	203	244	45
Internal Link Dist (ft)		116	246		459		353	
Turn Bay Length (ft)				110		105		
Base Capacity (vph)	482	921	890	343	1967	535	2371	1137
Starvation Cap Reductn	0	0	0	0	0	0	0	0
Spillback Cap Reductn	0	0	0	0	0	0	0	0
Storage Cap Reductn	0	0	0	0	0	0	0	0
Reduced v/c Ratio	0.35	0.09	0.29	0.11	0.36	0.35	0.30	0.20
Intersection Summary								

HCM 7th Signalized Intersection Summary
1: Ward Road & Oldham Parkway

Future Conditions Traffic Volumes
PM Peak Hour



Movement	EBL	EBT	EBR	WBL	WBT	WBR	NBL	NBT	NBR	SBL	SBT	SBR
Lane Configurations												
Traffic Volume (veh/h)	166	36	49	34	47	173	36	658	37	183	695	227
Future Volume (veh/h)	166	36	49	34	47	173	36	658	37	183	695	227
Initial Q (Qb), veh	0	0	0	0	0	0	0	0	0	0	0	0
Lane Width Adj.	1.00	1.00	1.00	1.00	1.00	1.00	1.00	1.00	1.00	1.00	1.00	1.00
Ped-Bike Adj(A_pbT)	1.00		1.00	1.00		1.00	1.00		1.00	1.00		1.00
Parking Bus, Adj	1.00	1.00	1.00	1.00	1.00	1.00	1.00	1.00	1.00	1.00	1.00	1.00
Work Zone On Approach		No			No			No			No	
Adj Sat Flow, veh/h/ln	1870	1870	1870	1870	1870	1870	1870	1870	1870	1870	1870	1870
Adj Flow Rate, veh/h	169	37	50	35	48	177	37	671	38	187	709	232
Peak Hour Factor	0.98	0.98	0.98	0.98	0.98	0.98	0.98	0.98	0.98	0.98	0.98	0.98
Percent Heavy Veh, %	2	2	2	2	2	2	2	2	2	2	2	2
Cap, veh/h	355	164	221	102	88	250	70	1103	62	243	1493	666
Arrive On Green	0.23	0.23	0.23	0.23	0.23	0.23	0.04	0.32	0.32	0.14	0.42	0.42
Sat Flow, veh/h	1156	721	974	128	388	1101	1781	3419	193	1781	3554	1585
Grp Volume(v), veh/h	169	0	87	260	0	0	37	348	361	187	709	232
Grp Sat Flow(s),veh/h/ln	1156	0	1695	1617	0	0	1781	1777	1836	1781	1777	1585
Q Serve(g_s), s	1.3	0.0	2.3	3.1	0.0	0.0	1.1	9.2	9.2	5.7	8.1	5.6
Cycle Q Clear(g_c), s	9.5	0.0	2.3	8.2	0.0	0.0	1.1	9.2	9.2	5.7	8.1	5.6
Prop In Lane	1.00		0.57	0.13		0.68	1.00		0.11	1.00		1.00
Lane Grp Cap(c), veh/h	355	0	385	441	0	0	70	573	592	243	1493	666
V/C Ratio(X)	0.48	0.00	0.23	0.59	0.00	0.00	0.53	0.61	0.61	0.77	0.47	0.35
Avail Cap(c_a), veh/h	897	0	1181	1184	0	0	456	1314	1357	711	3137	1399
HCM Platoon Ratio	1.00	1.00	1.00	1.00	1.00	1.00	1.00	1.00	1.00	1.00	1.00	1.00
Upstream Filter(I)	1.00	0.00	1.00	1.00	0.00	0.00	1.00	1.00	1.00	1.00	1.00	1.00
Uniform Delay (d), s/veh	20.5	0.0	17.6	19.8	0.0	0.0	26.3	15.9	15.9	23.3	11.7	11.0
Incr Delay (d2), s/veh	1.0	0.0	0.3	1.3	0.0	0.0	6.1	1.5	1.4	5.1	0.3	0.4
Initial Q Delay(d3), s/veh	0.0	0.0	0.0	0.0	0.0	0.0	0.0	0.0	0.0	0.0	0.0	0.0
%ile BackOfQ(95%),veh/ln	3.7	0.0	1.6	5.2	0.0	0.0	1.0	6.2	6.4	4.5	4.8	3.0
Unsig. Movement Delay, s/veh												
LnGrp Delay(d), s/veh	21.5	0.0	17.9	21.0	0.0	0.0	32.5	17.4	17.4	28.3	12.1	11.4
LnGrp LOS	C		B	C			C	B	B	C	B	B
Approach Vol, veh/h		256			260			746			1128	
Approach Delay, s/veh		20.3			21.0			18.1			14.6	
Approach LOS		C			C			B			B	
Timer - Assigned Phs	1	2		4	5	6		8				
Phs Duration (G+Y+Rc), s	7.9	29.2		18.8	13.3	23.7		18.8				
Change Period (Y+Rc), s	5.7	5.7		6.1	5.7	5.7		6.1				
Max Green Setting (Gmax), s	14.3	49.3		38.9	22.3	41.3		38.9				
Max Q Clear Time (g_c+I1), s	3.1	10.1		10.2	7.7	11.2		11.5				
Green Ext Time (p_c), s	0.0	9.7		1.7	0.4	6.8		1.2				
Intersection Summary												
HCM 7th Control Delay, s/veh			17.0									
HCM 7th LOS			B									
Notes												
User approved pedestrian interval to be less than phase max green.												

HCM 7th TWSC
2: Jefferson Street & Oldham Parkway

Future Conditions Traffic Volumes
PM Peak Hour

Intersection												
Int Delay, s/veh	3											
Movement	EBL	EBT	EBR	WBL	WBT	WBR	NBL	NBT	NBR	SBL	SBT	SBR
Lane Configurations	↗	↗↘		↗	↗↘				↗			↗
Traffic Vol, veh/h	2	576	33	218	336	278	0	0	217	0	0	2
Future Vol, veh/h	2	576	33	218	336	278	0	0	217	0	0	2
Conflicting Peds, #/hr	0	0	0	0	0	0	0	0	0	0	0	0
Sign Control	Free	Free	Free	Free	Free	Free	Stop	Stop	Stop	Stop	Stop	Stop
RT Channelized	-	-	None	-	-	None	-	-	None	-	-	None
Storage Length	150	-	-	400	-	-	-	-	0	-	-	0
Veh in Median Storage, #	-	0	-	-	0	-	-	0	-	-	0	-
Grade, %	-	0	-	-	0	-	-	0	-	-	0	-
Peak Hour Factor	98	98	98	98	98	98	98	98	98	98	98	98
Heavy Vehicles, %	2	2	2	2	2	2	2	2	2	2	2	2
Mvmt Flow	2	588	34	222	343	284	0	0	221	0	0	2













Major/Minor	Major1			Major2			Minor1			Minor2		
Conflicting Flow All	627	0	0	621	0	0	-	-	311	-	-	313
Stage 1	-	-	-	-	-	-	-	-	-	-	-	-
Stage 2	-	-	-	-	-	-	-	-	-	-	-	-
Critical Hdwy	4.14	-	-	4.14	-	-	-	-	6.94	-	-	6.94
Critical Hdwy Stg 1	-	-	-	-	-	-	-	-	-	-	-	-
Critical Hdwy Stg 2	-	-	-	-	-	-	-	-	-	-	-	-
Follow-up Hdwy	2.22	-	-	2.22	-	-	-	-	3.32	-	-	3.32
Pot Cap-1 Maneuver	951	-	-	955	-	-	0	0	685	0	0	683
Stage 1	-	-	-	-	-	-	0	0	-	0	0	-
Stage 2	-	-	-	-	-	-	0	0	-	0	0	-
Platoon blocked, %		-	-		-	-				-	-	
Mov Cap-1 Maneuver	951	-	-	955	-	-	-	-	685	-	-	683
Mov Cap-2 Maneuver	-	-	-	-	-	-	-	-	-	-	-	-
Stage 1	-	-	-	-	-	-	-	-	-	-	-	-
Stage 2	-	-	-	-	-	-	-	-	-	-	-	-

Approach	EB			WB			NB			SB		
HCM Control Delay, s/v	0.03			2.6			12.74			10.29		
HCM LOS							B			B		

Minor Lane/Major Mvmt	NBLn1	EBL	EBT	EBR	WBL	WBT	WBR	SBLn1
Capacity (veh/h)	685	951	-	-	955	-	-	683
HCM Lane V/C Ratio	0.323	0.002	-	-	0.233	-	-	0.003
HCM Control Delay (s/veh)	12.7	8.8	-	-	9.9	-	-	10.3
HCM Lane LOS	B	A	-	-	A	-	-	B
HCM 95th %tile Q(veh)	1.4	0	-	-	0.9	-	-	0

Queues
3: M-291 & Oldham Parkway

Future Conditions Traffic Volumes
PM Peak Hour

												
Lane Group	EBL	EBT	EBR	WBL	WBT	WBR	NBL	NBT	NBR	SBL	SBT	SBR
Lane Group Flow (vph)	579	5	250	179	10	209	265	2073	153	230	2466	531
v/c Ratio	1.04	0.01	0.59	0.71	0.09	0.57	0.92	0.87	0.17	0.75	1.04	0.55
Control Delay (s/veh)	98.6	44.4	14.8	71.0	55.5	7.3	60.9	13.5	0.3	69.5	63.0	6.7
Queue Delay	0.0	0.0	0.0	0.0	0.0	0.0	0.0	0.0	0.0	0.0	0.0	0.0
Total Delay (s/veh)	98.6	44.4	14.8	71.0	55.5	7.3	60.9	13.5	0.3	69.5	63.0	6.7
Queue Length 50th (ft)	~250	3	17	71	8	0	105	230	0	91	~757	45
Queue Length 95th (ft)	#364	16	98	#119	26	11	m#140	m277	m1	#145	#851	135
Internal Link Dist (ft)		201			629			1398			887	
Turn Bay Length (ft)	345						250		365	300		300
Base Capacity (vph)	555	271	422	251	110	367	286	2360	857	310	2363	965
Starvation Cap Reductn	0	0	0	0	0	0	0	0	0	0	0	0
Spillback Cap Reductn	0	0	0	0	0	0	0	0	0	0	0	0
Storage Cap Reductn	0	0	0	0	0	0	0	0	0	0	0	0
Reduced v/c Ratio	1.04	0.02	0.59	0.71	0.09	0.57	0.93	0.88	0.18	0.74	1.04	0.55

Intersection Summary

~ Volume exceeds capacity, queue is theoretically infinite.
Queue shown is maximum after two cycles.

95th percentile volume exceeds capacity, queue may be longer.
Queue shown is maximum after two cycles.

m Volume for 95th percentile queue is metered by upstream signal.

HCM 7th Signalized Intersection Summary
3: M-291 & Oldham Parkway

Future Conditions Traffic Volumes
PM Peak Hour



Movement	EBL	EBT	EBR	WBL	WBT	WBR	NBL	NBT	NBR	SBL	SBT	SBR
Lane Configurations	↔↔	↑	↗	↔↔	↑	↗	↔↔	↑↑↑	↗	↔↔	↑↑↑	↗
Traffic Volume (veh/h)	567	5	245	175	10	205	260	2032	150	225	2417	520
Future Volume (veh/h)	567	5	245	175	10	205	260	2032	150	225	2417	520
Initial Q (Qb), veh	0	0	0	0	0	0	0	0	0	0	0	0
Lane Width Adj.	1.00	1.00	1.00	1.00	1.00	1.00	1.00	1.00	1.00	1.00	1.00	1.00
Ped-Bike Adj(A_pbT)	1.00		1.00	1.00		1.00	1.00		1.00	1.00		1.00
Parking Bus, Adj	1.00	1.00	1.00	1.00	1.00	1.00	1.00	1.00	1.00	1.00	1.00	1.00
Work Zone On Approach		No			No			No			No	
Adj Sat Flow, veh/h/ln	1870	1870	1870	1870	1870	1870	1870	1870	1870	1870	1870	1870
Adj Flow Rate, veh/h	579	5	0	179	10	209	265	2073	0	230	2466	0
Peak Hour Factor	0.98	0.98	0.98	0.98	0.98	0.98	0.98	0.98	0.98	0.98	0.98	0.98
Percent Heavy Veh, %	2	2	2	2	2	2	2	2	2	2	2	2
Cap, veh/h	559	285		234	111	94	473	2643		286	2370	
Arrive On Green	0.16	0.15	0.00	0.07	0.06	0.06	0.27	1.00	0.00	0.08	0.46	0.00
Sat Flow, veh/h	3456	1870	1585	3456	1870	1585	3456	5106	1585	3456	5106	1585
Grp Volume(v), veh/h	579	5	0	179	10	209	265	2073	0	230	2466	0
Grp Sat Flow(s),veh/h/ln	1728	1870	1585	1728	1870	1585	1728	1702	1585	1728	1702	1585
Q Serve(g_s), s	19.4	0.3	0.0	6.1	0.6	7.1	7.9	0.0	0.0	7.8	55.7	0.0
Cycle Q Clear(g_c), s	19.4	0.3	0.0	6.1	0.6	7.1	7.9	0.0	0.0	7.8	55.7	0.0
Prop In Lane	1.00		1.00	1.00		1.00	1.00		1.00	1.00		1.00
Lane Grp Cap(c), veh/h	559	285		234	111	94	473	2643		286	2370	
V/C Ratio(X)	1.04	0.02		0.76	0.09	2.23	0.56	0.78		0.81	1.04	
Avail Cap(c_a), veh/h	559	285		253	111	94	473	2643		311	2370	
HCM Platoon Ratio	1.00	1.00	1.00	1.00	1.00	1.00	2.00	2.00	2.00	1.00	1.00	1.00
Upstream Filter(I)	1.00	1.00	0.00	1.00	1.00	1.00	0.42	0.42	0.00	1.00	1.00	0.00
Uniform Delay (d), s/veh	50.3	43.2	0.0	55.0	53.4	56.5	40.5	0.0	0.0	54.1	32.2	0.0
Incr Delay (d2), s/veh	47.8	0.0	0.0	12.1	0.3	585.7	0.6	1.0	0.0	13.4	30.0	0.0
Initial Q Delay(d3), s/veh	0.0	0.0	0.0	0.0	0.0	0.0	0.0	0.0	0.0	0.0	0.0	0.0
%ile BackOfQ(95%),veh/ln	18.2	0.2	0.0	5.5	0.5	29.5	4.9	0.5	0.0	6.9	37.4	0.0
Unsig. Movement Delay, s/veh												
LnGrp Delay(d), s/veh	98.1	43.3	0.0	67.1	53.7	642.2	41.1	1.0	0.0	67.5	62.2	0.0
LnGrp LOS	F	D		E	D	F	D	A		E	F	
Approach Vol, veh/h		584			398			2338			2696	
Approach Delay, s/veh		97.6			368.7			5.6			62.6	
Approach LOS		F			F			A			E	
Timer - Assigned Phs	1	2	3	4	5	6	7	8				
Phs Duration (G+Y+Rc), s	16.6	69.4	15.4	25.3	23.7	62.3	26.6	14.1				
Change Period (Y+Rc), s	6.7	* 7.2	7.3	7.0	7.2	6.6	7.2	* 7				
Max Green Setting (Gmax), s	10.8	* 56	8.8	17.4	10.0	55.7	19.4	* 7.1				
Max Q Clear Time (g_c+I1), s	9.8	2.0	8.1	2.3	9.9	57.7	21.4	9.1				
Green Ext Time (p_c), s	0.1	35.9	0.0	0.0	0.0	0.0	0.0	0.0				

Intersection Summary

HCM 7th Control Delay, s/veh	64.1
HCM 7th LOS	E

Notes

User approved pedestrian interval to be less than phase max green.
* HCM 7th computational engine requires equal clearance times for the phases crossing the barrier.

Unsignalized Delay for [NBR, EBR, SBR] is excluded from calculations of the approach delay and intersection delay.

Queues
4: Jefferson Street & Persels Road

Future Conditions Traffic Volumes
PM Peak Hour























Lane Group	EBL	EBT	WBL	WBT	WBR	NBL	NBT	SBL	SBT
Lane Group Flow (vph)	54	427	210	444	62	22	285	130	144
v/c Ratio	0.13	0.30	0.32	0.47	0.07	0.06	0.72	0.50	0.30
Control Delay (s/veh)	15.0	27.5	17.9	22.6	3.6	26.5	33.5	36.2	28.3
Queue Delay	0.0	0.0	0.0	0.3	0.0	0.0	0.0	0.0	0.0
Total Delay (s/veh)	15.0	27.5	17.9	23.0	3.6	26.5	33.5	36.2	28.3
Queue Length 50th (ft)	16	114	76	199	0	12	105	76	62
Queue Length 95th (ft)	41	198	m121	457	m3	28	186	111	123
Internal Link Dist (ft)		1272		101			1173		315
Turn Bay Length (ft)	110		175			110		150	
Base Capacity (vph)	393	1540	654	944	856	351	532	269	523
Starvation Cap Reductn	0	0	0	148	0	0	0	0	0
Spillback Cap Reductn	0	0	0	0	0	0	0	0	0
Storage Cap Reductn	0	0	0	0	0	0	0	0	0
Reduced v/c Ratio	0.14	0.28	0.32	0.56	0.07	0.06	0.54	0.48	0.28

Intersection Summary

m Volume for 95th percentile queue is metered by upstream signal.

HCM 7th Signalized Intersection Summary
4: Jefferson Street & Persels Road

Future Conditions Traffic Volumes
PM Peak Hour

												
Movement	EBL	EBT	EBR	WBL	WBT	WBR	NBL	NBT	NBR	SBL	SBT	SBR
Lane Configurations												
Traffic Volume (veh/h)	53	399	20	206	435	61	22	61	219	127	74	67
Future Volume (veh/h)	53	399	20	206	435	61	22	61	219	127	74	67
Initial Q (Qb), veh	0	0	0	0	0	0	0	0	0	0	0	0
Lane Width Adj.	1.00	1.00	1.00	1.00	1.00	1.00	1.00	1.00	1.00	1.00	1.00	1.00
Ped-Bike Adj(A_pbT)	1.00		1.00	1.00		1.00	1.00		1.00	1.00		1.00
Parking Bus, Adj	1.00	1.00	1.00	1.00	1.00	1.00	1.00	1.00	1.00	1.00	1.00	1.00
Work Zone On Approach		No			No			No			No	
Adj Sat Flow, veh/h/ln	1870	1870	1870	1870	1870	1870	1870	1870	1870	1870	1870	1870
Adj Flow Rate, veh/h	54	407	20	210	444	62	22	62	223	130	76	68
Peak Hour Factor	0.98	0.98	0.98	0.98	0.98	0.98	0.98	0.98	0.98	0.98	0.98	0.98
Percent Heavy Veh, %	2	2	2	2	2	2	2	2	2	2	2	2
Cap, veh/h	563	587	29	779	503	426	348	71	257	241	218	195
Arrive On Green	0.28	0.17	0.17	0.76	0.54	0.54	0.04	0.20	0.20	0.08	0.24	0.24
Sat Flow, veh/h	1781	3448	169	1781	1870	1585	1781	357	1283	1781	910	814
Grp Volume(v), veh/h	54	209	218	210	444	62	22	0	285	130	0	144
Grp Sat Flow(s),veh/h/ln	1781	1777	1840	1781	1870	1585	1781	0	1639	1781	0	1724
Q Serve(g_s), s	0.0	13.3	13.4	0.0	25.1	1.9	1.1	0.0	20.2	6.6	0.0	8.3
Cycle Q Clear(g_c), s	0.0	13.3	13.4	0.0	25.1	1.9	1.1	0.0	20.2	6.6	0.0	8.3
Prop In Lane	1.00		0.09	1.00		1.00	1.00		0.78	1.00		0.47
Lane Grp Cap(c), veh/h	563	302	313	779	503	426	348	0	328	241	0	412
V/C Ratio(X)	0.10	0.69	0.70	0.27	0.88	0.15	0.06	0.00	0.87	0.54	0.00	0.35
Avail Cap(c_a), veh/h	563	681	705	779	717	608	420	0	424	288	0	488
HCM Platoon Ratio	1.00	1.00	1.00	2.00	2.00	2.00	1.00	1.00	1.00	1.00	1.00	1.00
Upstream Filter(I)	1.00	1.00	1.00	1.00	1.00	1.00	1.00	0.00	1.00	1.00	0.00	1.00
Uniform Delay (d), s/veh	30.9	46.8	46.9	8.4	26.1	14.2	34.8	0.0	46.5	34.3	0.0	37.9
Incr Delay (d2), s/veh	0.1	12.3	12.1	0.3	19.7	0.7	0.1	0.0	18.0	2.6	0.0	1.1
Initial Q Delay(d3), s/veh	0.0	0.0	0.0	0.0	0.0	0.0	0.0	0.0	0.0	0.0	0.0	0.0
%ile BackOfQ(95%),veh/ln	2.1	11.1	11.5	2.7	15.8	1.7	0.9	0.0	14.9	5.4	0.0	6.5
Unsig. Movement Delay, s/veh												
LnGrp Delay(d), s/veh	31.0	59.1	58.9	8.6	45.8	15.0	34.9	0.0	64.5	37.0	0.0	39.0
LnGrp LOS	C	E	E	A	D	B	C		E	D		D
Approach Vol, veh/h		481			716			307				274
Approach Delay, s/veh		55.9			32.2			62.3				38.0
Approach LOS		E			C			E				D
Timer - Assigned Phs	1	2	3	4	5	6	7	8				
Phs Duration (G+Y+Rc), s	50.7	25.4	14.9	29.0	38.9	37.2	10.2	33.7				
Change Period (Y+Rc), s	5.0	5.0	5.0	5.0	5.0	5.0	5.0	5.0				
Max Green Setting (Gmax), s	10.0	46.0	13.0	31.0	10.0	46.0	10.0	34.0				
Max Q Clear Time (g_c+I1), s	2.0	15.4	8.6	22.2	2.0	27.1	3.1	10.3				
Green Ext Time (p_c), s	0.5	5.1	0.2	1.8	0.1	5.2	0.0	1.4				
Intersection Summary												
HCM 7th Control Delay, s/veh			44.7									
HCM 7th LOS			D									

Queues
5: M-291 & Persels Road/Bailey Road

Future Conditions Traffic Volumes
PM Peak Hour



Lane Group	EBL	EBT	EBR	WBL	WBT	WBR	NBL	NBT	NBR	SBL	SBT	SBR
Lane Group Flow (vph)	536	236	104	692	248	332	169	1660	591	252	2231	506
v/c Ratio	0.94	1.00	0.35	0.96	0.63	0.92	0.69	0.79	0.60	0.78	1.00	0.56
Control Delay (s/veh)	67.7	110.8	6.9	73.1	58.6	52.8	70.3	34.8	5.9	36.4	24.5	1.1
Queue Delay	0.0	0.0	0.0	0.0	0.0	0.0	0.0	0.0	0.0	0.0	0.0	0.0
Total Delay (s/veh)	67.7	110.8	6.9	73.1	58.6	52.8	70.3	34.8	5.9	36.4	24.5	1.1
Queue Length 50th (ft)	221	~100	4	275	97	100	67	407	19	91	~383	0
Queue Length 95th (ft)	#336	#189	34	#396	142	#273	#112	470	108	m95	m326	m2
Internal Link Dist (ft)		341			1421			2289			1398	
Turn Bay Length (ft)	200		150	280		290	310		350	330		
Base Capacity (vph)	566	235	296	718	415	367	243	2076	971	323	2213	893
Starvation Cap Reductn	0	0	0	0	0	0	0	0	0	0	0	0
Spillback Cap Reductn	0	0	0	0	0	0	0	0	0	0	0	0
Storage Cap Reductn	0	0	0	0	0	0	0	0	0	0	0	0
Reduced v/c Ratio	0.95	1.00	0.35	0.96	0.60	0.90	0.70	0.80	0.61	0.78	1.01	0.57

Intersection Summary

























~ Volume exceeds capacity, queue is theoretically infinite.
Queue shown is maximum after two cycles.

95th percentile volume exceeds capacity, queue may be longer.
Queue shown is maximum after two cycles.

m Volume for 95th percentile queue is metered by upstream signal.

HCM 7th Signalized Intersection Summary
5: M-291 & Persels Road/Bailey Road

Future Conditions Traffic Volumes
PM Peak Hour

												
Movement	EBL	EBT	EBR	WBL	WBT	WBR	NBL	NBT	NBR	SBL	SBT	SBR
Lane Configurations												
Traffic Volume (veh/h)	525	231	102	678	243	325	166	1627	579	247	2186	496
Future Volume (veh/h)	525	231	102	678	243	325	166	1627	579	247	2186	496
Initial Q (Qb), veh	0	0	0	0	0	0	0	0	0	0	0	0
Lane Width Adj.	1.00	1.00	1.00	1.00	1.00	1.00	1.00	1.00	1.00	1.00	1.00	1.00
Ped-Bike Adj(A_pbT)	1.00		1.00	1.00		1.00	1.00		1.00	1.00		1.00
Parking Bus, Adj	1.00	1.00	1.00	1.00	1.00	1.00	1.00	1.00	1.00	1.00	1.00	1.00
Work Zone On Approach		No			No			No			No	
Adj Sat Flow, veh/h/ln	1870	1870	1856	1870	1870	1870	1870	1870	1870	1870	1870	1870
Adj Flow Rate, veh/h	536	236	104	692	248	332	169	1660	0	252	2231	0
Peak Hour Factor	0.98	0.98	0.98	0.98	0.98	0.98	0.98	0.98	0.98	0.98	0.98	0.98
Percent Heavy Veh, %	2	2	3	2	2	2	2	2	2	2	2	2
Cap, veh/h	547	237	105	726	418	186	224	2040		353	2248	
Arrive On Green	0.05	0.02	0.02	0.21	0.12	0.12	0.06	0.40	0.00	0.20	0.88	0.00
Sat Flow, veh/h	3456	3554	1572	3456	3554	1585	3456	5106	1585	3456	5106	1585
Grp Volume(v), veh/h	536	236	104	692	248	332	169	1660	0	252	2231	0
Grp Sat Flow(s),veh/h/ln	1728	1777	1572	1728	1777	1585	1728	1702	1585	1728	1702	1585
Q Serve(g_s), s	18.6	8.0	6.5	23.7	7.9	14.1	5.8	34.7	0.0	8.2	49.7	0.0
Cycle Q Clear(g_c), s	18.6	8.0	6.5	23.7	7.9	14.1	5.8	34.7	0.0	8.2	49.7	0.0
Prop In Lane	1.00		1.00	1.00		1.00	1.00		1.00	1.00		1.00
Lane Grp Cap(c), veh/h	547	237	105	726	418	186	224	2040		353	2248	
V/C Ratio(X)	0.98	1.00	0.99	0.95	0.59	1.78	0.75	0.81		0.71	0.99	
Avail Cap(c_a), veh/h	547	237	105	726	418	186	245	2085		353	2248	
HCM Platoon Ratio	0.33	0.33	0.33	1.00	1.00	1.00	1.00	1.00	1.00	2.00	2.00	2.00
Upstream Filter(I)	1.00	1.00	1.00	1.00	1.00	1.00	1.00	1.00	0.00	0.13	0.13	0.00
Uniform Delay (d), s/veh	56.7	58.7	38.8	46.8	50.2	53.0	55.2	32.1	0.0	46.1	7.0	0.0
Incr Delay (d2), s/veh	33.2	57.3	85.2	22.7	2.3	373.0	11.5	3.7	0.0	0.9	5.4	0.0
Initial Q Delay(d3), s/veh	0.0	0.0	0.0	0.0	0.0	0.0	0.0	0.0	0.0	0.0	0.0	0.0
%ile BackOfQ(95%),veh/ln	16.6	9.5	8.8	18.1	6.5	39.6	5.1	20.4	0.0	4.2	4.9	0.0
Unsig. Movement Delay, s/veh												
LnGrp Delay(d), s/veh	89.8	116.0	124.1	69.5	52.5	425.9	66.7	35.8	0.0	47.0	12.4	0.0
LnGrp LOS	F	F	F	E	D	F	E	D		D	B	
Approach Vol, veh/h		876			1272			1829			2483	
Approach Delay, s/veh		100.9			159.2			38.6			15.9	
Approach LOS		F			F			D			B	
Timer - Assigned Phs	1	2	3	4	5	6	7	8				
Phs Duration (G+Y+Rc), s	18.3	54.4	32.3	15.0	13.9	58.8	26.1	21.2				
Change Period (Y+Rc), s	6.0	6.5	7.1	7.0	6.1	6.0	7.1	* 7.1				
Max Green Setting (Gmax), s	11.3	49.0	25.1	8.0	8.5	52.2	19.0	* 14				
Max Q Clear Time (g_c+I1), s	10.2	36.7	25.7	10.0	7.8	51.7	20.6	16.1				
Green Ext Time (p_c), s	0.1	11.2	0.0	0.0	0.0	0.5	0.0	0.0				
Intersection Summary												
HCM 7th Control Delay, s/veh			62.1									
HCM 7th LOS			E									
Notes												
User approved pedestrian interval to be less than phase max green.												
* HCM 7th computational engine requires equal clearance times for the phases crossing the barrier.												

Unsignalized Delay for [NBR, SBR] is excluded from calculations of the approach delay and intersection delay.

Intersection						
Int Delay, s/veh	0.2					
Movement	EBL	EBR	NBL	NBT	SBT	SBR
Lane Configurations		↗		↕	↕	
Traffic Vol, veh/h	0	18	0	333	598	0
Future Vol, veh/h	0	18	0	333	598	0
Conflicting Peds, #/hr	0	0	0	0	0	0
Sign Control	Stop	Stop	Free	Free	Free	Free
RT Channelized	-	None	-	None	-	None
Storage Length	-	0	-	-	-	-
Veh in Median Storage, #	0	-	-	0	0	-
Grade, %	0	-	-	0	0	-
Peak Hour Factor	98	98	98	98	98	98
Heavy Vehicles, %	2	2	2	2	2	2
Mvmt Flow	0	18	0	340	610	0

Major/Minor	Minor2	Major1	Major2			
Conflicting Flow All	-	610	-	0	-	0
Stage 1	-	-	-	-	-	-
Stage 2	-	-	-	-	-	-
Critical Hdwy	-	6.23	-	-	-	-
Critical Hdwy Stg 1	-	-	-	-	-	-
Critical Hdwy Stg 2	-	-	-	-	-	-
Follow-up Hdwy	-	3.319	-	-	-	-
Pot Cap-1 Maneuver	0	493	0	-	-	0
Stage 1	0	-	0	-	-	0
Stage 2	0	-	0	-	-	0
Platoon blocked, %				-	-	
Mov Cap-1 Maneuver	-	493	-	-	-	-
Mov Cap-2 Maneuver	-	-	-	-	-	-
Stage 1	-	-	-	-	-	-
Stage 2	-	-	-	-	-	-

Approach	EB	NB	SB
HCM Control Delay, s/v12.58		0	0
HCM LOS	B		

Minor Lane/Major Mvmt	NBT EBLn1	SBT
Capacity (veh/h)	- 493	-
HCM Lane V/C Ratio	- 0.037	-
HCM Control Delay (s/veh)	- 12.6	-
HCM Lane LOS	- B	-
HCM 95th %tile Q(veh)	- 0.1	-

Queues
7: Oldham Parkway & Access 2























Future Conditions Traffic Volumes
PM Peak Hour



Lane Group	EBL	EBT	WBL	WBT	NBL	NBT	NBR	SBL	SBT
Lane Group Flow (vph)	14	93	296	23	99	218	28	4	252
v/c Ratio	0.02	0.12	0.54	0.03	0.27	0.36	0.05	0.01	0.42
Control Delay (s/veh)	6.5	3.3	12.4	6.0	12.8	12.5	5.4	10.2	13.1
Queue Delay	0.0	0.0	0.0	0.0	0.0	0.0	0.0	0.0	0.0
Total Delay (s/veh)	6.5	3.3	12.4	6.0	12.8	12.5	5.4	10.2	13.1
Queue Length 50th (ft)	1	2	36	2	13	29	0	1	35
Queue Length 95th (ft)	8	20	104	11	49	90	12	6	103
Internal Link Dist (ft)		202		215		382			334
Turn Bay Length (ft)					150			150	
Base Capacity (vph)	1382	1643	1298	1825	1088	1805	1534	1123	1786
Starvation Cap Reductn	0	0	0	0	0	0	0	0	0
Spillback Cap Reductn	0	0	0	0	0	0	0	0	0
Storage Cap Reductn	0	0	0	0	0	0	0	0	0
Reduced v/c Ratio	0.01	0.06	0.23	0.01	0.09	0.12	0.02	0.00	0.14
Intersection Summary									

HCM 7th Signalized Intersection Summary
7: Oldham Parkway & Access 2

Future Conditions Traffic Volumes
PM Peak Hour

												
Movement	EBL	EBT	EBR	WBL	WBT	WBR	NBL	NBT	NBR	SBL	SBT	SBR
Lane Configurations												
Traffic Volume (veh/h)	14	20	72	290	20	3	97	214	27	4	231	16
Future Volume (veh/h)	14	20	72	290	20	3	97	214	27	4	231	16
Initial Q (Qb), veh	0	0	0	0	0	0	0	0	0	0	0	0
Lane Width Adj.	1.00	1.00	1.00	1.00	1.00	1.00	1.00	1.00	1.00	1.00	1.00	1.00
Ped-Bike Adj(A_pbT)	1.00		1.00	1.00		1.00	1.00		1.00	1.00		1.00
Parking Bus, Adj	1.00	1.00	1.00	1.00	1.00	1.00	1.00	1.00	1.00	1.00	1.00	1.00
Work Zone On Approach		No			No			No			No	
Adj Sat Flow, veh/h/ln	1870	1870	1870	1870	1870	1870	1870	1870	1870	1870	1870	1870
Adj Flow Rate, veh/h	14	20	73	296	20	3	99	218	0	4	236	16
Peak Hour Factor	0.98	0.98	0.98	0.98	0.98	0.98	0.98	0.98	0.98	0.98	0.98	0.98
Percent Heavy Veh, %	2	2	2	2	2	2	2	2	2	2	2	2
Cap, veh/h	735	122	445	665	549	82	508	601		536	557	38
Arrive On Green	0.35	0.35	0.35	0.35	0.35	0.35	0.32	0.32	0.00	0.32	0.32	0.32
Sat Flow, veh/h	1388	352	1286	1303	1589	238	1128	1870	1585	1163	1732	117
Grp Volume(v), veh/h	14	0	93	296	0	23	99	218	0	4	0	252
Grp Sat Flow(s),veh/h/ln	1388	0	1639	1303	0	1827	1128	1870	1585	1163	0	1849
Q Serve(g_s), s	0.2	0.0	1.1	5.5	0.0	0.2	2.0	2.4	0.0	0.1	0.0	2.9
Cycle Q Clear(g_c), s	0.4	0.0	1.1	6.6	0.0	0.2	4.9	2.4	0.0	2.5	0.0	2.9
Prop In Lane	1.00		0.78	1.00		0.13	1.00		1.00	1.00		0.06
Lane Grp Cap(c), veh/h	735	0	566	665	0	632	508	601		536	0	594
V/C Ratio(X)	0.02	0.00	0.16	0.44	0.00	0.04	0.19	0.36		0.01	0.00	0.42
Avail Cap(c_a), veh/h	3825	0	4215	3566	0	4700	1877	2872		1948	0	2840
HCM Platoon Ratio	1.00	1.00	1.00	1.00	1.00	1.00	1.00	1.00	1.00	1.00	1.00	1.00
Upstream Filter(I)	1.00	0.00	1.00	1.00	0.00	1.00	1.00	1.00	0.00	1.00	0.00	1.00
Uniform Delay (d), s/veh	6.0	0.0	6.1	8.4	0.0	5.9	9.1	7.0	0.0	8.0	0.0	7.2
Incr Delay (d2), s/veh	0.0	0.0	0.1	0.5	0.0	0.0	0.2	0.4	0.0	0.0	0.0	0.5
Initial Q Delay(d3), s/veh	0.0	0.0	0.0	0.0	0.0	0.0	0.0	0.0	0.0	0.0	0.0	0.0
%ile BackOfQ(95%),veh/ln	0.1	0.0	0.4	1.8	0.0	0.1	0.6	1.1	0.0	0.0	0.0	1.3
Unsig. Movement Delay, s/veh												
LnGrp Delay(d), s/veh	6.0	0.0	6.3	8.9	0.0	5.9	9.3	7.4	0.0	8.0	0.0	7.7
LnGrp LOS	A		A	A		A	A	A		A		A
Approach Vol, veh/h		107			319			317			256	
Approach Delay, s/veh		6.2			8.7			8.0			7.7	
Approach LOS		A			A			A			A	
Timer - Assigned Phs		2		4		6		8				
Phs Duration (G+Y+Rc), s		13.2		13.8		13.2		13.8				
Change Period (Y+Rc), s		4.5		4.5		4.5		4.5				
Max Green Setting (Gmax), s		41.5		69.5		41.5		69.5				
Max Q Clear Time (g_c+I1), s		6.9		3.1		4.9		8.6				
Green Ext Time (p_c), s		1.7		0.7		1.6		1.2				
Intersection Summary												
HCM 7th Control Delay, s/veh			7.9									
HCM 7th LOS			A									
Notes												
Unsignalized Delay for [NBR] is excluded from calculations of the approach delay and intersection delay.												

HCM 7th TWSC
8: Oldham Parkway & Access 3

Future Conditions Traffic Volumes
PM Peak Hour

Intersection												
Int Delay, s/veh	2.3											
Movement	EBL	EBT	EBR	WBL	WBT	WBR	NBL	NBT	NBR	SBL	SBT	SBR
Lane Configurations		↕			↕		↗	↘			↕	
Traffic Vol, veh/h	7	2	31	35	2	2	33	162	36	2	185	8
Future Vol, veh/h	7	2	31	35	2	2	33	162	36	2	185	8
Conflicting Peds, #/hr	0	0	0	0	0	0	0	0	0	0	0	0
Sign Control	Stop	Stop	Stop	Stop	Stop	Stop	Free	Free	Free	Free	Free	Free
RT Channelized	-	-	None	-	-	None	-	-	None	-	-	None
Storage Length	-	-	-	-	-	-	150	-	-	-	-	-
Veh in Median Storage, #	-	0	-	-	0	-	-	0	-	-	0	-
Grade, %	-	0	-	-	0	-	-	0	-	-	0	-
Peak Hour Factor	98	98	98	98	98	98	98	98	98	98	98	98
Heavy Vehicles, %	2	2	2	2	2	2	2	2	2	2	2	2
Mvmt Flow	7	2	32	36	2	2	34	165	37	2	189	8

Major/Minor	Minor2		Minor1		Major1		Major2					
Conflicting Flow All	431	466	193	445	452	184	197	0	0	202	0	0
Stage 1	197	197	-	251	251	-	-	-	-	-	-	-
Stage 2	234	269	-	194	201	-	-	-	-	-	-	-
Critical Hdwy	7.12	6.52	6.22	7.12	6.52	6.22	4.12	-	-	4.12	-	-
Critical Hdwy Stg 1	6.12	5.52	-	6.12	5.52	-	-	-	-	-	-	-
Critical Hdwy Stg 2	6.12	5.52	-	6.12	5.52	-	-	-	-	-	-	-
Follow-up Hdwy	3.518	4.018	3.318	3.518	4.018	3.318	2.218	-	-	2.218	-	-
Pot Cap-1 Maneuver	535	494	849	523	503	859	1376	-	-	1370	-	-
Stage 1	805	738	-	753	699	-	-	-	-	-	-	-
Stage 2	769	686	-	808	735	-	-	-	-	-	-	-
Platoon blocked, %								-	-	-	-	-
Mov Cap-1 Maneuver	518	481	849	489	490	859	1376	-	-	1370	-	-
Mov Cap-2 Maneuver	518	481	-	489	490	-	-	-	-	-	-	-
Stage 1	804	737	-	735	682	-	-	-	-	-	-	-
Stage 2	747	670	-	774	734	-	-	-	-	-	-	-

Approach	EB		WB		NB		SB	
HCM Control Delay, s/v10.16			12.82		1.1		0.08	
HCM LOS	B		B					

Minor Lane/Major Mvmt	NBL	NBT	NBR	EBLn1WBLn1	SBL	SBT	SBR
Capacity (veh/h)	1376	-	-	738	500	18	-
HCM Lane V/C Ratio	0.024	-	-	0.055	0.08	0.001	-
HCM Control Delay (s/veh)	7.7	-	-	10.2	12.8	7.6	0
HCM Lane LOS	A	-	-	B	B	A	A
HCM 95th %tile Q(veh)	0.1	-	-	0.2	0.3	0	-

Intersection						
Int Delay, s/veh	0.3					
Movement	EBT	EBR	WBL	WBT	NBL	NBR
Lane Configurations	1			4	3	
Traffic Vol, veh/h	191	4	4	167	4	4
Future Vol, veh/h	191	4	4	167	4	4
Conflicting Peds, #/hr	0	0	0	0	0	0
Sign Control	Free	Free	Free	Free	Stop	Stop
RT Channelized	-	None	-	None	-	None
Storage Length	-	-	-	-	0	-
Veh in Median Storage, #	0	-	-	0	0	-
Grade, %	0	-	-	0	0	-
Peak Hour Factor	98	98	98	98	98	98
Heavy Vehicles, %	2	2	2	2	2	2
Mvmt Flow	195	4	4	170	4	4

Major/Minor	Major1	Major2	Minor1		
Conflicting Flow All	0	0	199	0	376
Stage 1	-	-	-	-	197
Stage 2	-	-	-	-	179
Critical Hdwy	-	-	4.12	-	6.42
Critical Hdwy Stg 1	-	-	-	-	5.42
Critical Hdwy Stg 2	-	-	-	-	5.42
Follow-up Hdwy	-	-	2.218	-	3.518
Pot Cap-1 Maneuver	-	-	1373	-	626
Stage 1	-	-	-	-	836
Stage 2	-	-	-	-	852
Platoon blocked, %	-	-	-	-	-
Mov Cap-1 Maneuver	-	-	1373	-	624
Mov Cap-2 Maneuver	-	-	-	-	624
Stage 1	-	-	-	-	836
Stage 2	-	-	-	-	849

Approach	EB	WB	NB
HCM Control Delay, s/v	0	0.18	10.08
HCM LOS			B

Minor Lane/Major Mvmt	NBLn1	EBT	EBR	WBL	WBT
Capacity (veh/h)	717	-	-	42	-
HCM Lane V/C Ratio	0.011	-	-	0.003	-
HCM Control Delay (s/veh)	10.1	-	-	7.6	0
HCM Lane LOS	B	-	-	A	A
HCM 95th %tile Q(veh)	0	-	-	0	-

Intersection						
Int Delay, s/veh	0.3					
Movement	EBT	EBR	WBL	WBT	NBL	NBR
Lane Configurations	h			4	W	
Traffic Vol, veh/h	186	4	4	157	4	4
Future Vol, veh/h	186	4	4	157	4	4
Conflicting Peds, #/hr	0	0	0	0	0	0
Sign Control	Free	Free	Free	Free	Stop	Stop
RT Channelized	-	None	-	None	-	None
Storage Length	-	-	-	-	0	-
Veh in Median Storage, #	0	-	-	0	0	-
Grade, %	0	-	-	0	0	-
Peak Hour Factor	98	98	98	98	98	98
Heavy Vehicles, %	2	2	2	2	2	2
Mvmt Flow	190	4	4	160	4	4

Major/Minor	Major1	Major2	Minor1		
Conflicting Flow All	0	0	194	0	360
Stage 1	-	-	-	-	192
Stage 2	-	-	-	-	168
Critical Hdwy	-	-	4.12	-	6.42
Critical Hdwy Stg 1	-	-	-	-	5.42
Critical Hdwy Stg 2	-	-	-	-	5.42
Follow-up Hdwy	-	-	2.218	-	3.518
Pot Cap-1 Maneuver	-	-	1379	-	639
Stage 1	-	-	-	-	841
Stage 2	-	-	-	-	861
Platoon blocked, %	-	-	-	-	-
Mov Cap-1 Maneuver	-	-	1379	-	637
Mov Cap-2 Maneuver	-	-	-	-	637
Stage 1	-	-	-	-	841
Stage 2	-	-	-	-	859

Approach	EB	WB	NB
HCM Control Delay, s/v	0	0.19	10
HCM LOS			B

Minor Lane/Major Mvmt	NBLn1	EBT	EBR	WBL	WBT
Capacity (veh/h)	728	-	-	45	-
HCM Lane V/C Ratio	0.011	-	-	0.003	-
HCM Control Delay (s/veh)	10	-	-	7.6	0
HCM Lane LOS	B	-	-	A	A
HCM 95th %tile Q(veh)	0	-	-	0	-

Intersection						
Int Delay, s/veh	3.4					
Movement	WBL	WBR	NBT	NBR	SBL	SBT
Lane Configurations	W		T		T	T
Traffic Vol, veh/h	119	13	160	15	15	150
Future Vol, veh/h	119	13	160	15	15	150
Conflicting Peds, #/hr	0	0	0	0	0	0
Sign Control	Stop	Stop	Free	Free	Free	Free
RT Channelized	-	None	-	None	-	None
Storage Length	0	-	-	-	100	-
Veh in Median Storage, #	0	-	0	-	-	0
Grade, %	0	-	0	-	-	0
Peak Hour Factor	98	98	98	98	98	98
Heavy Vehicles, %	2	2	2	2	2	2
Mvmt Flow	121	13	163	15	15	153

Major/Minor	Minor1	Major1	Major2		
Conflicting Flow All	355	171	0	0	179
Stage 1	171	-	-	-	-
Stage 2	184	-	-	-	-
Critical Hdwy	6.42	6.22	-	-	4.12
Critical Hdwy Stg 1	5.42	-	-	-	-
Critical Hdwy Stg 2	5.42	-	-	-	-
Follow-up Hdwy	3.518	3.318	-	-	2.218
Pot Cap-1 Maneuver	643	873	-	-	1397
Stage 1	859	-	-	-	-
Stage 2	848	-	-	-	-
Platoon blocked, %			-	-	-
Mov Cap-1 Maneuver	636	873	-	-	1397
Mov Cap-2 Maneuver	678	-	-	-	-
Stage 1	859	-	-	-	-
Stage 2	839	-	-	-	-

Approach	WB	NB	SB
HCM Control Delay, s/v	11.45	0	0.69
HCM LOS	B		

Minor Lane/Major Mvmt	NBT	NBRWBLn1	SBL	SBT
Capacity (veh/h)	-	-	693	1397
HCM Lane V/C Ratio	-	-	0.194	0.011
HCM Control Delay (s/veh)	-	-	11.4	7.6
HCM Lane LOS	-	-	B	A
HCM 95th %tile Q(veh)	-	-	0.7	0

Intersection						
Int Delay, s/veh	1.2					
Movement	WBL	WBR	NBT	NBR	SBL	SBT
Lane Configurations	W		T		T	T
Traffic Vol, veh/h	2	27	173	2	28	165
Future Vol, veh/h	2	27	173	2	28	165
Conflicting Peds, #/hr	0	0	0	0	0	0
Sign Control	Stop	Stop	Free	Free	Free	Free
RT Channelized	-	None	-	None	-	None
Storage Length	-	-	-	-	100	-
Veh in Median Storage, #	0	-	0	-	-	0
Grade, %	0	-	0	-	-	0
Peak Hour Factor	98	98	98	98	98	98
Heavy Vehicles, %	2	2	2	2	2	2
Mvmt Flow	2	28	177	2	29	168

Major/Minor	Minor1	Major1	Major2		
Conflicting Flow All	403	178	0	0	179
Stage 1	178	-	-	-	-
Stage 2	226	-	-	-	-
Critical Hdwy	6.42	6.22	-	-	4.12
Critical Hdwy Stg 1	5.42	-	-	-	-
Critical Hdwy Stg 2	5.42	-	-	-	-
Follow-up Hdwy	3.518	3.318	-	-	2.218
Pot Cap-1 Maneuver	603	865	-	-	1397
Stage 1	853	-	-	-	-
Stage 2	812	-	-	-	-
Platoon blocked, %			-	-	-
Mov Cap-1 Maneuver	591	865	-	-	1397
Mov Cap-2 Maneuver	644	-	-	-	-
Stage 1	853	-	-	-	-
Stage 2	795	-	-	-	-

Approach	WB	NB	SB
HCM Control Delay, s/v	9.41	0	1.11
HCM LOS	A		

Minor Lane/Major Mvmt	NBT	NBRWBLn1	SBL	SBT
Capacity (veh/h)	-	-	845	1397
HCM Lane V/C Ratio	-	-	0.035	0.02
HCM Control Delay (s/veh)	-	-	9.4	7.6
HCM Lane LOS	-	-	A	A
HCM 95th %tile Q(veh)	-	-	0.1	0.1

HCM 7th TWSC
 13: Jefferson Street & Access 6

Future Conditions Traffic Volumes
 PM Peak Hour

Intersection												
Int Delay, s/veh	4.3											
Movement	EBL	EBT	EBR	WBL	WBT	WBR	NBL	NBT	NBR	SBL	SBT	SBR
Lane Configurations		↕			↕		↗	↖		↗	↖	
Traffic Vol, veh/h	27	2	13	59	2	59	15	122	72	59	124	30
Future Vol, veh/h	27	2	13	59	2	59	15	122	72	59	124	30
Conflicting Peds, #/hr	0	0	0	0	0	0	0	0	0	0	0	0
Sign Control	Stop	Stop	Stop	Stop	Stop	Stop	Free	Free	Free	Free	Free	Free
RT Channelized	-	-	None	-	-	None	-	-	None	-	-	None
Storage Length	-	-	-	-	-	-	100	-	-	100	-	-
Veh in Median Storage, #	-	0	-	-	0	-	-	0	-	-	0	-
Grade, %	-	0	-	-	0	-	-	0	-	-	0	-
Peak Hour Factor	98	98	98	98	98	98	98	98	98	98	98	98
Heavy Vehicles, %	2	2	2	2	2	2	2	2	2	2	2	2
Mvmt Flow	28	2	13	60	2	60	15	124	73	60	127	31

Major/Minor	Minor2		Minor1		Major1		Major2					
Conflicting Flow All	418	491	142	440	469	161	157	0	0	198	0	0
Stage 1	262	262	-	192	192	-	-	-	-	-	-	-
Stage 2	156	229	-	248	278	-	-	-	-	-	-	-
Critical Hdwy	7.12	6.52	6.22	7.12	6.52	6.22	4.12	-	-	4.12	-	-
Critical Hdwy Stg 1	6.12	5.52	-	6.12	5.52	-	-	-	-	-	-	-
Critical Hdwy Stg 2	6.12	5.52	-	6.12	5.52	-	-	-	-	-	-	-
Follow-up Hdwy	3.518	4.018	3.318	3.518	4.018	3.318	2.218	-	-	2.218	-	-
Pot Cap-1 Maneuver	545	478	906	528	492	884	1423	-	-	1375	-	-
Stage 1	743	691	-	810	742	-	-	-	-	-	-	-
Stage 2	846	715	-	756	681	-	-	-	-	-	-	-
Platoon blocked, %								-	-	-	-	-
Mov Cap-1 Maneuver	478	453	906	490	465	884	1423	-	-	1375	-	-
Mov Cap-2 Maneuver	478	453	-	490	465	-	-	-	-	-	-	-
Stage 1	710	661	-	801	734	-	-	-	-	-	-	-
Stage 2	778	707	-	710	651	-	-	-	-	-	-	-

Approach	EB	WB	NB	SB
HCM Control Delay, s/v11.98		12.14	0.54	2.14
HCM LOS	B	B		

Minor Lane/Major Mvmt	NBL	NBT	NBR	EBLn1WBLn1	SBL	SBT	SBR
Capacity (veh/h)	1423	-	-	558	626	1375	-
HCM Lane V/C Ratio	0.011	-	-	0.077	0.195	0.044	-
HCM Control Delay (s/veh)	7.6	-	-	12	12.1	7.7	-
HCM Lane LOS	A	-	-	B	B	A	-
HCM 95th %tile Q(veh)	0	-	-	0.2	0.7	0.1	-

Intersection						
Int Delay, s/veh	1.7					
Movement	WBL	WBR	NBT	NBR	SBL	SBT
Lane Configurations	↘		↗		↘	↗
Traffic Vol, veh/h	19	19	186	22	57	194
Future Vol, veh/h	19	19	186	22	57	194
Conflicting Peds, #/hr	0	0	0	0	0	0
Sign Control	Stop	Stop	Free	Free	Free	Free
RT Channelized	-	None	-	None	-	None
Storage Length	0	-	-	-	100	-
Veh in Median Storage, #	0	-	0	-	-	0
Grade, %	0	-	0	-	-	0
Peak Hour Factor	98	98	98	98	98	98
Heavy Vehicles, %	2	2	2	2	2	2
Mvmt Flow	19	19	190	22	58	198

Major/Minor	Minor1	Major1	Major2		
Conflicting Flow All	515	201	0	0	212
Stage 1	201	-	-	-	-
Stage 2	314	-	-	-	-
Critical Hdwy	6.42	6.22	-	-	4.12
Critical Hdwy Stg 1	5.42	-	-	-	-
Critical Hdwy Stg 2	5.42	-	-	-	-
Follow-up Hdwy	3.518	3.318	-	-	2.218
Pot Cap-1 Maneuver	520	840	-	-	1358
Stage 1	833	-	-	-	-
Stage 2	740	-	-	-	-
Platoon blocked, %			-	-	-
Mov Cap-1 Maneuver	497	840	-	-	1358
Mov Cap-2 Maneuver	572	-	-	-	-
Stage 1	833	-	-	-	-
Stage 2	709	-	-	-	-

Approach	WB	NB	SB
HCM Control Delay, s/v	10.61	0	1.76
HCM LOS	B		

Minor Lane/Major Mvmt	NBT	NBRWBLn1	SBL	SBT
Capacity (veh/h)	-	-	681	1358
HCM Lane V/C Ratio	-	-	0.057	0.043
HCM Control Delay (s/veh)	-	-	10.6	7.8
HCM Lane LOS	-	-	B	A
HCM 95th %tile Q(veh)	-	-	0.2	0.1

HCM Unsignalized Intersection Capacity Analysis
 15: Access 8 & Oldham Parkway

Future Conditions Traffic Volumes
 PM Peak Hour



Movement	EBT	EBR	WBL	WBT	NBL	NBR	
Lane Configurations	↑↑↑↑			↑↑		↗	
Traffic Volume (veh/h)	780	7	0	828	0	40	
Future Volume (Veh/h)	780	7	0	828	0	40	
Sign Control	Free			Free	Stop		
Grade	0%			0%	0%		
Peak Hour Factor	0.98	0.98	0.98	0.98	0.98	0.98	
Hourly flow rate (vph)	796	7	0	845	0	41	
Pedestrians							
Lane Width (ft)							
Walking Speed (ft/s)							
Percent Blockage							
Right turn flare (veh)							
Median type	None			None			
Median storage (veh)							
Upstream signal (ft)	1111			281			
pX, platoon unblocked							
vC, conflicting volume			803	1222	203		
vC1, stage 1 conf vol							
vC2, stage 2 conf vol							
vCu, unblocked vol			803	1222	203		
tC, single (s)			4.1	6.8	6.9		
tC, 2 stage (s)							
tF (s)			2.2	3.5	3.3		
p0 queue free %			100	100	95		
cM capacity (veh/h)			817	172	805		
Direction, Lane #	EB 1	EB 2	EB 3	EB 4	WB 1	WB 2	NB 1
Volume Total	227	227	227	121	423	423	41
Volume Left	0	0	0	0	0	0	0
Volume Right	0	0	0	7	0	0	41
cSH	1700	1700	1700	1700	1700	1700	805
Volume to Capacity	0.13	0.13	0.13	0.07	0.25	0.25	0.05
Queue Length 95th (ft)	0	0	0	0	0	0	4
Control Delay (s/veh)	0.0	0.0	0.0	0.0	0.0	0.0	9.7
Lane LOS							A
Approach Delay (s/veh)	0.0			0.0			9.7
Approach LOS							A
Intersection Summary							
Average Delay			0.2				
Intersection Capacity Utilization			26.2%		ICU Level of Service		A
Analysis Period (min)			15				

Queues
1: Ward Road & Oldham Parkway

Future Conditions Traffic Volumes
SAT Peak Hour



Lane Group	EBL	EBT	WBT	NBL	NBT	SBL	SBT	SBR
Lane Group Flow (vph)	196	55	231	38	729	191	473	235
v/c Ratio	0.72	0.11	0.44	0.22	0.65	0.59	0.27	0.26
Control Delay (s/veh)	45.1	13.6	15.7	45.8	28.7	42.7	16.1	3.4
Queue Delay	0.0	0.0	0.0	0.0	0.0	0.0	0.0	0.0
Total Delay (s/veh)	45.1	13.6	15.7	45.8	28.7	42.7	16.1	3.4
Queue Length 50th (ft)	88	7	41	18	160	88	81	0
Queue Length 95th (ft)	208	40	127	63	311	208	161	47
Internal Link Dist (ft)		116	246		459		353	
Turn Bay Length (ft)				110		105		
Base Capacity (vph)	537	918	898	331	1760	539	2210	1077
Starvation Cap Reductn	0	0	0	0	0	0	0	0
Spillback Cap Reductn	0	0	0	0	0	0	0	0
Storage Cap Reductn	0	0	0	0	0	0	0	0
Reduced v/c Ratio	0.36	0.06	0.26	0.11	0.41	0.35	0.21	0.22

Intersection Summary

HCM 7th Signalized Intersection Summary
1: Ward Road & Oldham Parkway

Future Conditions Traffic Volumes
SAT Peak Hour



Movement	EBL	EBT	EBR	WBL	WBT	WBR	NBL	NBT	NBR	SBL	SBT	SBR	
Lane Configurations													
Traffic Volume (veh/h)	192	20	34	40	21	166	37	677	37	187	464	230	
Future Volume (veh/h)	192	20	34	40	21	166	37	677	37	187	464	230	
Initial Q (Qb), veh	0	0	0	0	0	0	0	0	0	0	0	0	
Lane Width Adj.	1.00	1.00	1.00	1.00	1.00	1.00	1.00	1.00	1.00	1.00	1.00	1.00	
Ped-Bike Adj(A_pbT)	1.00		1.00	1.00		1.00	1.00		1.00	1.00		1.00	
Parking Bus, Adj	1.00	1.00	1.00	1.00	1.00	1.00	1.00	1.00	1.00	1.00	1.00	1.00	
Work Zone On Approach		No			No			No			No		
Adj Sat Flow, veh/h/ln	1870	1870	1870	1870	1870	1870	1870	1870	1870	1870	1870	1870	
Adj Flow Rate, veh/h	196	20	35	41	21	169	38	691	38	191	473	235	
Peak Hour Factor	0.98	0.98	0.98	0.98	0.98	0.98	0.98	0.98	0.98	0.98	0.98	0.98	
Percent Heavy Veh, %	2	2	2	2	2	2	2	2	2	2	2	2	
Cap, veh/h	376	140	244	115	58	266	71	1112	61	248	1507	672	
Arrive On Green	0.23	0.23	0.23	0.23	0.23	0.23	0.04	0.32	0.32	0.14	0.42	0.42	
Sat Flow, veh/h	1193	610	1068	175	252	1165	1781	3425	188	1781	3554	1585	
Grp Volume(v), veh/h	196	0	55	231	0	0	38	358	371	191	473	235	
Grp Sat Flow(s),veh/h/ln	1193	0	1678	1593	0	0	1781	1777	1836	1781	1777	1585	
Q Serve(g_s), s	2.6	0.0	1.5	2.5	0.0	0.0	1.2	9.7	9.7	5.9	5.0	5.7	
Cycle Q Clear(g_c), s	9.9	0.0	1.5	7.3	0.0	0.0	1.2	9.7	9.7	5.9	5.0	5.7	
Prop In Lane	1.00		0.64	0.18		0.73	1.00		0.10	1.00		1.00	
Lane Grp Cap(c), veh/h	376	0	384	439	0	0	71	577	596	248	1507	672	
V/C Ratio(X)	0.52	0.00	0.14	0.53	0.00	0.00	0.54	0.62	0.62	0.77	0.31	0.35	
Avail Cap(c_a), veh/h	961	0	1206	1202	0	0	448	1196	1236	729	2953	1317	
HCM Platoon Ratio	1.00	1.00	1.00	1.00	1.00	1.00	1.00	1.00	1.00	1.00	1.00	1.00	
Upstream Filter(I)	1.00	0.00	1.00	1.00	0.00	0.00	1.00	1.00	1.00	1.00	1.00	1.00	
Uniform Delay (d), s/veh	20.9	0.0	17.5	19.7	0.0	0.0	26.8	16.3	16.3	23.6	10.9	11.1	
Incr Delay (d2), s/veh	1.1	0.0	0.2	1.0	0.0	0.0	6.2	1.6	1.5	5.0	0.2	0.4	
Initial Q Delay(d3), s/veh	0.0	0.0	0.0	0.0	0.0	0.0	0.0	0.0	0.0	0.0	0.0	0.0	
%ile BackOfQ(95%),veh/ln	4.4	0.0	1.0	4.6	0.0	0.0	1.1	6.6	6.8	4.7	3.0	3.1	
Unsig. Movement Delay, s/veh													
LnGrp Delay(d), s/veh	22.0	0.0	17.7	20.7	0.0	0.0	33.0	17.8	17.8	28.7	11.1	11.5	
LnGrp LOS	C		B	C			C	B	B	C	B	B	
Approach Vol, veh/h	251						231		767		899		
Approach Delay, s/veh	21.1						20.7		18.5		14.9		
Approach LOS	C						C		B		B		
Timer - Assigned Phs	1	2	4		5	6	8						
Phs Duration (G+Y+Rc), s	8.0	29.8	19.1		13.6	24.2	19.1						
Change Period (Y+Rc), s	5.7	5.7	6.1		5.7	5.7	6.1						
Max Green Setting (Gmax), s	14.3	47.3	40.9		23.3	38.3	40.9						
Max Q Clear Time (g_c+I1), s	3.2	7.7	9.3		7.9	11.7	11.9						
Green Ext Time (p_c), s	0.0	6.5	1.5		0.4	6.8	1.1						
Intersection Summary													
HCM 7th Control Delay, s/veh			17.6										
HCM 7th LOS			B										
Notes													
User approved pedestrian interval to be less than phase max green.													

HCM 7th TWSC
 2: Jefferson Street & Oldham Parkway

Future Conditions Traffic Volumes
 SAT Peak Hour

Intersection												
Int Delay, s/veh	3.1											
Movement	EBL	EBT	EBR	WBL	WBT	WBR	NBL	NBT	NBR	SBL	SBT	SBR
Lane Configurations	↗	↗↘		↗	↗↘				↗			↗
Traffic Vol, veh/h	3	623	27	221	343	307	0	0	237	0	0	3
Future Vol, veh/h	3	623	27	221	343	307	0	0	237	0	0	3
Conflicting Peds, #/hr	0	0	0	0	0	0	0	0	0	0	0	0
Sign Control	Free	Free	Free	Free	Free	Free	Stop	Stop	Stop	Stop	Stop	Stop
RT Channelized	-	-	None	-	-	None	-	-	None	-	-	None
Storage Length	150	-	-	400	-	-	-	-	0	-	-	0
Veh in Median Storage, #	-	0	-	-	0	-	-	0	-	-	0	-
Grade, %	-	0	-	-	0	-	-	0	-	-	0	-
Peak Hour Factor	98	98	98	98	98	98	98	98	98	98	98	98
Heavy Vehicles, %	2	2	2	2	2	2	2	2	2	2	2	2
Mvmt Flow	3	636	28	226	350	313	0	0	242	0	0	3













Major/Minor	Major1			Major2			Minor1			Minor2		
Conflicting Flow All	663	0	0	663	0	0	-	-	332	-	-	332
Stage 1	-	-	-	-	-	-	-	-	-	-	-	-
Stage 2	-	-	-	-	-	-	-	-	-	-	-	-
Critical Hdwy	4.14	-	-	4.14	-	-	-	-	6.94	-	-	6.94
Critical Hdwy Stg 1	-	-	-	-	-	-	-	-	-	-	-	-
Critical Hdwy Stg 2	-	-	-	-	-	-	-	-	-	-	-	-
Follow-up Hdwy	2.22	-	-	2.22	-	-	-	-	3.32	-	-	3.32
Pot Cap-1 Maneuver	921	-	-	921	-	-	0	0	664	0	0	664
Stage 1	-	-	-	-	-	-	0	0	-	0	0	-
Stage 2	-	-	-	-	-	-	0	0	-	0	0	-
Platoon blocked, %		-	-		-	-				-	-	
Mov Cap-1 Maneuver	921	-	-	921	-	-	-	-	664	-	-	664
Mov Cap-2 Maneuver	-	-	-	-	-	-	-	-	-	-	-	-
Stage 1	-	-	-	-	-	-	-	-	-	-	-	-
Stage 2	-	-	-	-	-	-	-	-	-	-	-	-

Approach	EB			WB			NB			SB		
HCM Control Delay, s/v	0.04			2.58			13.49			10.45		
HCM LOS							B			B		

Minor Lane/Major Mvmt	NBLn1	EBL	EBT	EBR	WBL	WBT	WBR	SBLn1
Capacity (veh/h)	664	921	-	-	921	-	-	664
HCM Lane V/C Ratio	0.364	0.003	-	-	0.245	-	-	0.005
HCM Control Delay (s/veh)	13.5	8.9	-	-	10.2	-	-	10.4
HCM Lane LOS	B	A	-	-	B	-	-	B
HCM 95th %tile Q(veh)	1.7	0	-	-	1	-	-	0

Queues
3: M-291 & Oldham Parkway

Future Conditions Traffic Volumes
SAT Peak Hour

												
Lane Group	EBL	EBT	EBR	WBL	WBT	WBR	NBL	NBT	NBR	SBL	SBT	SBR
Lane Group Flow (vph)	647	5	272	214	10	250	301	1597	184	276	1539	556
v/c Ratio	0.89	0.01	0.55	0.63	0.08	0.67	0.78	0.81	0.24	0.70	0.79	0.58
Control Delay (s/veh)	62.8	40.6	10.8	60.9	53.6	12.3	41.6	15.0	0.9	61.7	36.8	5.0
Queue Delay	0.0	0.0	0.0	0.0	0.0	0.0	0.0	0.0	0.0	0.0	0.0	0.0
Total Delay (s/veh)	62.8	40.6	10.8	60.9	53.6	12.3	41.6	15.0	0.9	61.7	36.8	5.0
Queue Length 50th (ft)	251	3	8	82	8	0	120	204	3	106	384	0
Queue Length 95th (ft)	#346	15	84	123	25	46	m#159	236	m7	#169	468	79
Internal Link Dist (ft)		201			629			1398			887	
Turn Bay Length (ft)	345						250		365	300		300
Base Capacity (vph)	740	360	515	366	161	402	394	1962	751	398	1948	949
Starvation Cap Reductn	0	0	0	0	0	0	0	0	0	0	0	0
Spillback Cap Reductn	0	0	0	0	0	0	0	0	0	0	0	0
Storage Cap Reductn	0	0	0	0	0	0	0	0	0	0	0	0
Reduced v/c Ratio	0.87	0.01	0.53	0.58	0.06	0.62	0.76	0.81	0.25	0.69	0.79	0.59

Intersection Summary

























95th percentile volume exceeds capacity, queue may be longer.

Queue shown is maximum after two cycles.

m Volume for 95th percentile queue is metered by upstream signal.

HCM 7th Signalized Intersection Summary
3: M-291 & Oldham Parkway

Future Conditions Traffic Volumes
SAT Peak Hour

												
Movement	EBL	EBT	EBR	WBL	WBT	WBR	NBL	NBT	NBR	SBL	SBT	SBR
Lane Configurations												
Traffic Volume (veh/h)	634	5	267	210	10	245	295	1565	180	270	1508	545
Future Volume (veh/h)	634	5	267	210	10	245	295	1565	180	270	1508	545
Initial Q (Qb), veh	0	0	0	0	0	0	0	0	0	0	0	0
Lane Width Adj.	1.00	1.00	1.00	1.00	1.00	1.00	1.00	1.00	1.00	1.00	1.00	1.00
Ped-Bike Adj(A_pbT)	1.00		1.00	1.00		1.00	1.00		1.00	1.00		1.00
Parking Bus, Adj	1.00	1.00	1.00	1.00	1.00	1.00	1.00	1.00	1.00	1.00	1.00	1.00
Work Zone On Approach		No			No			No			No	
Adj Sat Flow, veh/h/ln	1870	1870	1870	1870	1870	1870	1870	1870	1870	1870	1870	1870
Adj Flow Rate, veh/h	647	5	0	214	10	250	301	1597	0	276	1539	0
Peak Hour Factor	0.98	0.98	0.98	0.98	0.98	0.98	0.98	0.98	0.98	0.98	0.98	0.98
Percent Heavy Veh, %	2	2	2	2	2	2	2	2	2	2	2	2
Cap, veh/h	707	395		274	162	137	462	1933		332	1744	
Arrive On Green	0.20	0.21	0.00	0.08	0.09	0.09	0.27	0.76	0.00	0.10	0.34	0.00
Sat Flow, veh/h	3456	1870	1585	3456	1870	1585	3456	5106	1585	3456	5106	1585
Grp Volume(v), veh/h	647	5	0	214	10	250	301	1597	0	276	1539	0
Grp Sat Flow(s),veh/h/ln	1728	1870	1585	1728	1870	1585	1728	1702	1585	1728	1702	1585
Q Serve(g_s), s	22.0	0.3	0.0	7.3	0.6	10.4	9.3	24.4	0.0	9.4	34.1	0.0
Cycle Q Clear(g_c), s	22.0	0.3	0.0	7.3	0.6	10.4	9.3	24.4	0.0	9.4	34.1	0.0
Prop In Lane	1.00		1.00	1.00		1.00	1.00		1.00	1.00		1.00
Lane Grp Cap(c), veh/h	707	395		274	162	137	462	1933		332	1744	
V/C Ratio(X)	0.91	0.01		0.78	0.06	1.82	0.65	0.83		0.83	0.88	
Avail Cap(c_a), veh/h	746	395		369	162	137	462	1933		360	1791	
HCM Platoon Ratio	1.00	1.00	1.00	1.00	1.00	1.00	2.00	2.00	2.00	1.00	1.00	1.00
Upstream Filter(I)	1.00	1.00	0.00	1.00	1.00	1.00	0.60	0.60	0.00	1.00	1.00	0.00
Uniform Delay (d), s/veh	46.7	37.4	0.0	54.2	50.3	54.8	41.5	12.0	0.0	53.3	37.2	0.0
Incr Delay (d2), s/veh	15.4	0.0	0.0	7.5	0.2	396.0	2.0	2.6	0.0	14.3	6.9	0.0
Initial Q Delay(d3), s/veh	0.0	0.0	0.0	0.0	0.0	0.0	0.0	0.0	0.0	0.0	0.0	0.0
%ile BackOfQ(95%),veh/ln	16.4	0.2	0.0	6.3	0.5	31.2	6.0	7.2	0.0	8.2	20.9	0.0
Unsig. Movement Delay, s/veh												
LnGrp Delay(d), s/veh	62.1	37.4	0.0	61.7	50.5	450.8	43.4	14.6	0.0	67.6	44.1	0.0
LnGrp LOS	E	D		E	D	F	D	B		E	D	
Approach Vol, veh/h		652			474			1898			1815	
Approach Delay, s/veh		61.9			266.7			19.2			47.7	
Approach LOS		E			F			B			D	
Timer - Assigned Phs	1	2	3	4	5	6	7	8				
Phs Duration (G+Y+Rc), s	18.2	52.6	16.8	32.3	23.2	47.6	31.8	17.4				
Change Period (Y+Rc), s	6.7	* 7.2	7.3	7.0	7.2	6.6	7.2	* 7				
Max Green Setting (Gmax), s	12.5	* 44	12.8	23.2	13.8	42.1	25.9	* 10				
Max Q Clear Time (g_c+I1), s	11.4	26.4	9.3	2.3	11.3	36.1	24.0	12.4				
Green Ext Time (p_c), s	0.1	12.5	0.2	0.0	0.3	4.9	0.6	0.0				
Intersection Summary												
HCM 7th Control Delay, s/veh			59.9									
HCM 7th LOS			E									
Notes												
User approved pedestrian interval to be less than phase max green.												
* HCM 7th computational engine requires equal clearance times for the phases crossing the barrier.												

Unsignalized Delay for [NBR, EBR, SBR] is excluded from calculations of the approach delay and intersection delay.

Queues
4: Jefferson Street & Persels Road

Future Conditions Traffic Volumes
SAT Peak Hour























Lane Group	EBL	EBT	WBL	WBT	WBR	NBL	NBT	SBL	SBT
Lane Group Flow (vph)	76	333	87	345	52	11	131	126	131
v/c Ratio	0.13	0.19	0.11	0.34	0.05	0.03	0.45	0.37	0.27
Control Delay (s/veh)	10.7	19.7	10.5	15.1	1.8	30.2	25.1	36.1	18.2
Queue Delay	0.0	0.0	0.0	0.0	0.0	0.0	0.0	0.0	0.0
Total Delay (s/veh)	10.7	19.7	10.5	15.1	1.8	30.2	25.1	36.1	18.2
Queue Length 50th (ft)	20	78	23	139	0	6	34	76	32
Queue Length 95th (ft)	45	127	57	244	5	20	95	121	93
Internal Link Dist (ft)		1272		101			1173		315
Turn Bay Length (ft)	110		175			110		150	
Base Capacity (vph)	595	1734	750	1001	900	308	494	341	521
Starvation Cap Reductn	0	0	0	0	0	0	0	0	0
Spillback Cap Reductn	0	0	0	0	0	0	0	0	0
Storage Cap Reductn	0	0	0	0	0	0	0	0	0
Reduced v/c Ratio	0.13	0.19	0.12	0.34	0.06	0.04	0.27	0.37	0.25

Intersection Summary

HCM 7th Signalized Intersection Summary
4: Jefferson Street & Persels Road

Future Conditions Traffic Volumes
SAT Peak Hour

												
Movement	EBL	EBT	EBR	WBL	WBT	WBR	NBL	NBT	NBR	SBL	SBT	SBR
Lane Configurations												
Traffic Volume (veh/h)	74	322	4	85	338	51	11	42	86	123	45	83
Future Volume (veh/h)	74	322	4	85	338	51	11	42	86	123	45	83
Initial Q (Qb), veh	0	0	0	0	0	0	0	0	0	0	0	0
Lane Width Adj.	1.00	1.00	1.00	1.00	1.00	1.00	1.00	1.00	1.00	1.00	1.00	1.00
Ped-Bike Adj(A_pbT)	1.00		1.00	1.00		1.00	1.00		1.00	1.00		1.00
Parking Bus, Adj	1.00	1.00	1.00	1.00	1.00	1.00	1.00	1.00	1.00	1.00	1.00	1.00
Work Zone On Approach		No			No			No			No	
Adj Sat Flow, veh/h/ln	1870	1870	1870	1870	1870	1870	1870	1870	1870	1870	1870	1870
Adj Flow Rate, veh/h	76	329	4	87	345	52	11	43	88	126	46	85
Peak Hour Factor	0.98	0.98	0.98	0.98	0.98	0.98	0.98	0.98	0.98	0.98	0.98	0.98
Percent Heavy Veh, %	2	2	2	2	2	2	2	2	2	2	2	2
Cap, veh/h	789	489	6	967	406	344	247	68	140	270	107	197
Arrive On Green	0.41	0.14	0.14	0.98	0.43	0.43	0.03	0.12	0.12	0.08	0.18	0.18
Sat Flow, veh/h	1781	3596	44	1781	1870	1585	1781	548	1121	1781	588	1087
Grp Volume(v), veh/h	76	162	171	87	345	52	11	0	131	126	0	131
Grp Sat Flow(s),veh/h/ln	1781	1777	1862	1781	1870	1585	1781	0	1669	1781	0	1675
Q Serve(g_s), s	0.0	10.4	10.5	0.0	19.8	2.1	0.6	0.0	8.9	7.1	0.0	8.3
Cycle Q Clear(g_c), s	0.0	10.4	10.5	0.0	19.8	2.1	0.6	0.0	8.9	7.1	0.0	8.3
Prop In Lane	1.00		0.02	1.00		1.00	1.00		0.67	1.00		0.65
Lane Grp Cap(c), veh/h	789	242	253	967	406	344	247	0	209	270	0	304
V/C Ratio(X)	0.10	0.67	0.67	0.09	0.85	0.15	0.04	0.00	0.63	0.47	0.00	0.43
Avail Cap(c_a), veh/h	789	666	698	967	701	594	349	0	431	302	0	461
HCM Platoon Ratio	1.00	1.00	1.00	2.00	2.00	2.00	1.00	1.00	1.00	1.00	1.00	1.00
Upstream Filter(I)	1.00	1.00	1.00	1.00	1.00	1.00	1.00	0.00	1.00	1.00	0.00	1.00
Uniform Delay (d), s/veh	20.9	49.3	49.3	0.5	32.2	20.2	43.6	0.0	49.9	39.5	0.0	43.6
Incr Delay (d2), s/veh	0.1	14.0	13.4	0.1	19.4	0.9	0.1	0.0	6.5	1.8	0.0	2.1
Initial Q Delay(d3), s/veh	0.0	0.0	0.0	0.0	0.0	0.0	0.0	0.0	0.0	0.0	0.0	0.0
%ile BackOfQ(95%),veh/ln	2.3	9.4	9.7	0.1	14.1	1.7	0.5	0.0	7.4	5.8	0.0	6.5
Unsig. Movement Delay, s/veh												
LnGrp Delay(d), s/veh	21.0	63.3	62.8	0.6	51.6	21.1	43.7	0.0	56.3	41.3	0.0	45.7
LnGrp LOS	C	E	E	A	D	C	D		E	D		D
Approach Vol, veh/h		409			484			142			257	
Approach Delay, s/veh		55.2			39.2			55.4			43.5	
Approach LOS		E			D			E			D	
Timer - Assigned Phs	1	2	3	4	5	6	7	8				
Phs Duration (G+Y+Rc), s	63.8	21.3	14.9	20.0	54.1	31.1	8.1	26.8				
Change Period (Y+Rc), s	5.0	5.0	5.0	5.0	5.0	5.0	5.0	5.0				
Max Green Setting (Gmax), s	12.0	45.0	12.0	31.0	12.0	45.0	10.0	33.0				
Max Q Clear Time (g_c+I1), s	2.0	12.5	9.1	10.9	2.0	21.8	2.6	10.3				
Green Ext Time (p_c), s	0.2	3.9	0.1	1.2	0.2	4.2	0.0	1.2				
Intersection Summary												
HCM 7th Control Delay, s/veh				46.9								
HCM 7th LOS				D								

Queues
5: M-291 & Persels Road/Bailey Road

Future Conditions Traffic Volumes
SAT Peak Hour



























Lane Group	EBL	EBT	EBR	WBL	WBT	WBR	NBL	NBT	NBR	SBL	SBT	SBR
Lane Group Flow (vph)	324	208	103	473	176	331	148	1452	468	292	1488	390
v/c Ratio	0.61	0.61	0.26	0.79	0.43	0.81	0.51	0.74	0.53	0.68	0.68	0.43
Control Delay (s/veh)	49.4	48.6	2.5	57.6	51.6	29.0	59.2	35.4	5.6	36.7	11.0	1.4
Queue Delay	0.0	0.0	0.0	0.0	0.0	0.0	0.0	0.0	0.0	0.0	0.0	0.0
Total Delay (s/veh)	49.4	48.6	2.5	57.6	51.6	29.0	59.2	35.4	5.6	36.7	11.0	1.4
Queue Length 50th (ft)	126	84	2	181	68	56	57	359	11	115	98	3
Queue Length 95th (ft)	179	94	2	236	98	159	91	431	91	m138	121	m9
Internal Link Dist (ft)		341			1421			2289			1398	
Turn Bay Length (ft)	200		150	280		290	310		350	330		
Base Capacity (vph)	530	365	405	672	586	475	320	1952	882	429	2183	900
Starvation Cap Reductn	0	0	0	0	0	0	0	0	0	0	0	0
Spillback Cap Reductn	0	0	0	0	0	0	0	0	0	0	0	0
Storage Cap Reductn	0	0	0	0	0	0	0	0	0	0	0	0
Reduced v/c Ratio	0.61	0.57	0.25	0.70	0.30	0.70	0.46	0.74	0.53	0.68	0.68	0.43

Intersection Summary

m Volume for 95th percentile queue is metered by upstream signal.

HCM 7th Signalized Intersection Summary
5: M-291 & Persels Road/Bailey Road

Future Conditions Traffic Volumes
SAT Peak Hour

												
Movement	EBL	EBT	EBR	WBL	WBT	WBR	NBL	NBT	NBR	SBL	SBT	SBR
Lane Configurations												
Traffic Volume (veh/h)	318	204	101	464	172	324	145	1423	459	286	1458	382
Future Volume (veh/h)	318	204	101	464	172	324	145	1423	459	286	1458	382
Initial Q (Qb), veh	0	0	0	0	0	0	0	0	0	0	0	0
Lane Width Adj.	1.00	1.00	1.00	1.00	1.00	1.00	1.00	1.00	1.00	1.00	1.00	1.00
Ped-Bike Adj(A_pbT)	1.00		1.00	1.00		1.00	1.00		1.00	1.00		1.00
Parking Bus, Adj	1.00	1.00	1.00	1.00	1.00	1.00	1.00	1.00	1.00	1.00	1.00	1.00
Work Zone On Approach		No			No			No			No	
Adj Sat Flow, veh/h/ln	1870	1870	1856	1870	1870	1870	1870	1870	1870	1870	1870	1870
Adj Flow Rate, veh/h	324	208	103	473	176	331	148	1452	0	292	1488	0
Peak Hour Factor	0.98	0.98	0.98	0.98	0.98	0.98	0.98	0.98	0.98	0.98	0.98	0.98
Percent Heavy Veh, %	2	2	3	2	2	2	2	2	2	2	2	2
Cap, veh/h	389	280	124	692	589	263	206	1764		531	2262	
Arrive On Green	0.04	0.03	0.03	0.20	0.17	0.17	0.06	0.35	0.00	0.31	0.89	0.00
Sat Flow, veh/h	3456	3554	1572	3456	3554	1585	3456	5106	1585	3456	5106	1585
Grp Volume(v), veh/h	324	208	103	473	176	331	148	1452	0	292	1488	0
Grp Sat Flow(s),veh/h/ln	1728	1777	1572	1728	1777	1585	1728	1702	1585	1728	1702	1585
Q Serve(g_s), s	11.2	7.0	6.4	15.2	5.2	19.9	5.0	31.2	0.0	8.5	9.6	0.0
Cycle Q Clear(g_c), s	11.2	7.0	6.4	15.2	5.2	19.9	5.0	31.2	0.0	8.5	9.6	0.0
Prop In Lane	1.00		1.00	1.00		1.00	1.00		1.00	1.00		1.00
Lane Grp Cap(c), veh/h	389	280	124	692	589	263	206	1764		531	2262	
V/C Ratio(X)	0.83	0.74	0.83	0.68	0.30	1.26	0.72	0.82		0.55	0.66	
Avail Cap(c_a), veh/h	461	367	162	692	589	263	323	1808		531	2262	
HCM Platoon Ratio	0.33	0.33	0.33	1.00	1.00	1.00	1.00	1.00	1.00	2.00	2.00	2.00
Upstream Filter(I)	1.00	1.00	1.00	1.00	1.00	1.00	1.00	1.00	0.00	0.59	0.59	0.00
Uniform Delay (d), s/veh	56.7	57.2	38.5	44.5	43.9	50.0	55.4	35.9	0.0	38.1	4.4	0.0
Incr Delay (d2), s/veh	10.8	5.6	23.1	2.8	0.3	143.7	4.7	4.5	0.0	0.7	0.9	0.0
Initial Q Delay(d3), s/veh	0.0	0.0	0.0	0.0	0.0	0.0	0.0	0.0	0.0	0.0	0.0	0.0
%ile BackOfQ(95%),veh/ln	9.7	6.2	6.1	11.0	4.2	28.0	4.1	19.0	0.0	5.5	3.3	0.0
Unsig. Movement Delay, s/veh												
LnGrp Delay(d), s/veh	67.4	62.8	61.6	47.2	44.2	193.7	60.1	40.4	0.0	38.8	5.3	0.0
LnGrp LOS	E	E	E	D	D	F	E	D		D	A	
Approach Vol, veh/h		635			980			1600			1780	
Approach Delay, s/veh		65.0			96.2			42.3			10.8	
Approach LOS		E			F			D			B	
Timer - Assigned Phs	1	2	3	4	5	6	7	8				
Phs Duration (G+Y+Rc), s	24.4	47.9	31.1	16.5	13.2	59.2	20.6	27.0				
Change Period (Y+Rc), s	6.0	6.5	7.1	7.0	6.1	6.0	7.1	* 7.1				
Max Green Setting (Gmax), s	15.0	42.5	23.5	12.4	11.2	46.7	16.0	* 20				
Max Q Clear Time (g_c+I1), s	10.5	33.2	17.2	9.0	7.0	11.6	13.2	21.9				
Green Ext Time (p_c), s	0.4	8.2	1.0	0.5	0.1	26.6	0.3	0.0				
Intersection Summary												
HCM 7th Control Delay, s/veh			44.5									
HCM 7th LOS			D									
Notes												
User approved pedestrian interval to be less than phase max green.												
* HCM 7th computational engine requires equal clearance times for the phases crossing the barrier.												

Unsignalized Delay for [NBR, SBR] is excluded from calculations of the approach delay and intersection delay.

Intersection						
Int Delay, s/veh	0.3					
Movement	EBL	EBR	NBL	NBT	SBT	SBR
Lane Configurations		↗		↕↕	↕	
Traffic Vol, veh/h	0	26	0	341	632	0
Future Vol, veh/h	0	26	0	341	632	0
Conflicting Peds, #/hr	0	0	0	0	0	0
Sign Control	Stop	Stop	Free	Free	Free	Free
RT Channelized	-	None	-	None	-	None
Storage Length	-	0	-	-	-	-
Veh in Median Storage, #	0	-	-	0	0	-
Grade, %	0	-	-	0	0	-
Peak Hour Factor	98	98	98	98	98	98
Heavy Vehicles, %	2	2	2	2	2	2
Mvmt Flow	0	27	0	348	645	0

Major/Minor	Minor2	Major1	Major2		
Conflicting Flow All	-	645	-	0	-
Stage 1	-	-	-	-	-
Stage 2	-	-	-	-	-
Critical Hdwy	-	6.23	-	-	-
Critical Hdwy Stg 1	-	-	-	-	-
Critical Hdwy Stg 2	-	-	-	-	-
Follow-up Hdwy	-	3.319	-	-	-
Pot Cap-1 Maneuver	0	471	0	-	-
Stage 1	0	-	0	-	-
Stage 2	0	-	0	-	-
Platoon blocked, %				-	-
Mov Cap-1 Maneuver	-	471	-	-	-
Mov Cap-2 Maneuver	-	-	-	-	-
Stage 1	-	-	-	-	-
Stage 2	-	-	-	-	-

Approach	EB	NB	SB
HCM Control Delay, s/v13.09		0	0
HCM LOS	B		

Minor Lane/Major Mvmt	NBT EBLn1	SBT
Capacity (veh/h)	- 471	-
HCM Lane V/C Ratio	- 0.056	-
HCM Control Delay (s/veh)	- 13.1	-
HCM Lane LOS	- B	-
HCM 95th %tile Q(veh)	- 0.2	-

Queues
7: Oldham Parkway & Access 2























Future Conditions Traffic Volumes
SAT Peak Hour



Lane Group	EBL	EBT	WBL	WBT	NBL	NBT	NBR	SBL	SBT
Lane Group Flow (vph)	21	125	334	25	137	185	32	5	222
v/c Ratio	0.03	0.15	0.59	0.03	0.38	0.32	0.06	0.01	0.38
Control Delay (s/veh)	6.9	3.0	13.7	6.2	16.1	13.6	5.9	12.0	14.1
Queue Delay	0.0	0.0	0.0	0.0	0.0	0.0	0.0	0.0	0.0
Total Delay (s/veh)	6.9	3.0	13.7	6.2	16.1	13.6	5.9	12.0	14.1
Queue Length 50th (ft)	2	2	46	2	21	28	0	1	33
Queue Length 95th (ft)	12	24	140	13	78	92	15	7	107
Internal Link Dist (ft)		202		215		382			332
Turn Bay Length (ft)					150			150	
Base Capacity (vph)	1380	1628	1261	1807	1061	1711	1456	1097	1688
Starvation Cap Reductn	0	0	0	0	0	0	0	0	0
Spillback Cap Reductn	0	0	0	0	0	0	0	0	0
Storage Cap Reductn	0	0	0	0	0	0	0	0	0
Reduced v/c Ratio	0.02	0.08	0.26	0.01	0.13	0.11	0.02	0.00	0.13
Intersection Summary									

HCM 7th Signalized Intersection Summary
7: Oldham Parkway & Access 2

Future Conditions Traffic Volumes
SAT Peak Hour

												
Movement	EBL	EBT	EBR	WBL	WBT	WBR	NBL	NBT	NBR	SBL	SBT	SBR
Lane Configurations												
Traffic Volume (veh/h)	21	20	103	327	20	5	134	181	31	5	197	21
Future Volume (veh/h)	21	20	103	327	20	5	134	181	31	5	197	21
Initial Q (Qb), veh	0	0	0	0	0	0	0	0	0	0	0	0
Lane Width Adj.	1.00	1.00	1.00	1.00	1.00	1.00	1.00	1.00	1.00	1.00	1.00	1.00
Ped-Bike Adj(A_pbT)	1.00		1.00	1.00		1.00	1.00		1.00	1.00		1.00
Parking Bus, Adj	1.00	1.00	1.00	1.00	1.00	1.00	1.00	1.00	1.00	1.00	1.00	1.00
Work Zone On Approach		No			No			No			No	
Adj Sat Flow, veh/h/ln	1870	1870	1870	1870	1870	1870	1870	1870	1870	1870	1870	1870
Adj Flow Rate, veh/h	21	20	105	334	20	5	137	185	0	5	201	21
Peak Hour Factor	0.98	0.98	0.98	0.98	0.98	0.98	0.98	0.98	0.98	0.98	0.98	0.98
Percent Heavy Veh, %	2	2	2	2	2	2	2	2	2	2	2	2
Cap, veh/h	764	102	534	665	566	141	492	592		523	527	55
Arrive On Green	0.39	0.39	0.39	0.39	0.39	0.39	0.32	0.32	0.00	0.32	0.32	0.32
Sat Flow, veh/h	1386	260	1365	1266	1444	361	1159	1870	1585	1199	1665	174
Grp Volume(v), veh/h	21	0	125	334	0	25	137	185	0	5	0	222
Grp Sat Flow(s),veh/h/ln	1386	0	1625	1266	0	1805	1159	1870	1585	1199	0	1839
Q Serve(g_s), s	0.3	0.0	1.6	7.3	0.0	0.3	3.2	2.3	0.0	0.1	0.0	2.9
Cycle Q Clear(g_c), s	0.6	0.0	1.6	8.8	0.0	0.3	6.1	2.3	0.0	2.4	0.0	2.9
Prop In Lane	1.00		0.84	1.00		0.20	1.00		1.00	1.00		0.09
Lane Grp Cap(c), veh/h	764	0	636	665	0	707	492	592		523	0	582
V/C Ratio(X)	0.03	0.00	0.20	0.50	0.00	0.04	0.28	0.31		0.01	0.00	0.38
Avail Cap(c_a), veh/h	3391	0	3715	3064	0	4128	1647	2457		1718	0	2416
HCM Platoon Ratio	1.00	1.00	1.00	1.00	1.00	1.00	1.00	1.00	1.00	1.00	1.00	1.00
Upstream Filter(I)	1.00	0.00	1.00	1.00	0.00	1.00	1.00	1.00	0.00	1.00	0.00	1.00
Uniform Delay (d), s/veh	6.0	0.0	6.2	9.1	0.0	5.8	10.6	8.0	0.0	8.9	0.0	8.2
Incr Delay (d2), s/veh	0.0	0.0	0.1	0.6	0.0	0.0	0.3	0.3	0.0	0.0	0.0	0.4
Initial Q Delay(d3), s/veh	0.0	0.0	0.0	0.0	0.0	0.0	0.0	0.0	0.0	0.0	0.0	0.0
%ile BackOfQ(95%),veh/ln	0.1	0.0	0.6	2.5	0.0	0.1	1.1	1.2	0.0	0.0	0.0	1.5
Unsig. Movement Delay, s/veh												
LnGrp Delay(d), s/veh	6.0	0.0	6.3	9.7	0.0	5.8	10.9	8.3	0.0	8.9	0.0	8.6
LnGrp LOS	A		A	A		A	B	A		A		A
Approach Vol, veh/h	146		359				322		227			
Approach Delay, s/veh	6.3		9.4				9.4		8.6			
Approach LOS	A		A				A		A			
Timer - Assigned Phs	2		4				6		8			
Phs Duration (G+Y+Rc), s	14.3		16.6				14.3		16.6			
Change Period (Y+Rc), s	4.5		4.5				4.5		4.5			
Max Green Setting (Gmax), s	40.5		70.5				40.5		70.5			
Max Q Clear Time (g_c+I1), s	8.1		3.6				4.9		10.8			
Green Ext Time (p_c), s	1.7		0.9				1.4		1.4			
Intersection Summary												
HCM 7th Control Delay, s/veh			8.8									
HCM 7th LOS			A									
Notes												
Unsignalized Delay for [NBR] is excluded from calculations of the approach delay and intersection delay.												

HCM 7th TWSC
8: Oldham Parkway & Access 3

Future Conditions Traffic Volumes
SAT Peak Hour

Intersection												
Int Delay, s/veh	2.9											
Movement	EBL	EBT	EBR	WBL	WBT	WBR	NBL	NBT	NBR	SBL	SBT	SBR
Lane Configurations		↕			↕		↗	↖			↕	
Traffic Vol, veh/h	9	2	34	45	2	3	35	125	47	3	144	11
Future Vol, veh/h	9	2	34	45	2	3	35	125	47	3	144	11
Conflicting Peds, #/hr	0	0	0	0	0	0	0	0	0	0	0	0
Sign Control	Stop	Stop	Stop	Stop	Stop	Stop	Free	Free	Free	Free	Free	Free
RT Channelized	-	-	None	-	-	None	-	-	None	-	-	None
Storage Length	-	-	-	-	-	-	150	-	-	-	-	-
Veh in Median Storage, #	-	0	-	-	0	-	-	0	-	-	0	-
Grade, %	-	0	-	-	0	-	-	0	-	-	0	-
Peak Hour Factor	98	98	98	98	98	98	98	98	98	98	98	98
Heavy Vehicles, %	2	2	2	2	2	2	2	2	2	2	2	2
Mvmt Flow	9	2	35	46	2	3	36	128	48	3	147	11

Major/Minor	Minor2		Minor1		Major1		Major2					
Conflicting Flow All	359	406	153	377	387	152	158	0	0	176	0	0
Stage 1	159	159	-	223	223	-	-	-	-	-	-	-
Stage 2	200	247	-	154	164	-	-	-	-	-	-	-
Critical Hdwy	7.12	6.52	6.22	7.12	6.52	6.22	4.12	-	-	4.12	-	-
Critical Hdwy Stg 1	6.12	5.52	-	6.12	5.52	-	-	-	-	-	-	-
Critical Hdwy Stg 2	6.12	5.52	-	6.12	5.52	-	-	-	-	-	-	-
Follow-up Hdwy	3.518	4.018	3.318	3.518	4.018	3.318	2.218	-	-	2.218	-	-
Pot Cap-1 Maneuver	597	534	894	580	547	895	1421	-	-	1401	-	-
Stage 1	844	767	-	780	719	-	-	-	-	-	-	-
Stage 2	802	702	-	848	762	-	-	-	-	-	-	-
Platoon blocked, %								-	-	-	-	-
Mov Cap-1 Maneuver	576	520	894	540	532	895	1421	-	-	1401	-	-
Mov Cap-2 Maneuver	576	520	-	540	532	-	-	-	-	-	-	-
Stage 1	841	765	-	760	701	-	-	-	-	-	-	-
Stage 2	777	684	-	811	760	-	-	-	-	-	-	-

Approach	EB		WB		NB		SB	
HCM Control Delay, s/v	9.89		12.17		1.28		0.14	
HCM LOS	A		B					

Minor Lane/Major Mvmt	NBL	NBT	NBR	EBLn1	WBLn1	SBL	SBT	SBR
Capacity (veh/h)	1421	-	-	782	553	34	-	-
HCM Lane V/C Ratio	0.025	-	-	0.059	0.092	0.002	-	-
HCM Control Delay (s/veh)	7.6	-	-	9.9	12.2	7.6	0	-
HCM Lane LOS	A	-	-	A	B	A	A	-
HCM 95th %tile Q(veh)	0.1	-	-	0.2	0.3	0	-	-

Intersection						
Int Delay, s/veh	0.4					
Movement	EBT	EBR	WBL	WBT	NBL	NBR
Lane Configurations	T			T	T	
Traffic Vol, veh/h	153	5	5	132	5	5
Future Vol, veh/h	153	5	5	132	5	5
Conflicting Peds, #/hr	0	0	0	0	0	0
Sign Control	Free	Free	Free	Free	Stop	Stop
RT Channelized	-	None	-	None	-	None
Storage Length	-	-	-	-	0	-
Veh in Median Storage, #	0	-	-	0	0	-
Grade, %	0	-	-	0	0	-
Peak Hour Factor	98	98	98	98	98	98
Heavy Vehicles, %	2	2	2	2	2	2
Mvmt Flow	156	5	5	135	5	5

Major/Minor	Major1	Major2	Minor1		
Conflicting Flow All	0	0	161	0	304
Stage 1	-	-	-	-	159
Stage 2	-	-	-	-	145
Critical Hdwy	-	-	4.12	-	6.42
Critical Hdwy Stg 1	-	-	-	-	5.42
Critical Hdwy Stg 2	-	-	-	-	5.42
Follow-up Hdwy	-	-	2.218	-	3.518
Pot Cap-1 Maneuver	-	-	1418	-	688
Stage 1	-	-	-	-	870
Stage 2	-	-	-	-	882
Platoon blocked, %	-	-	-	-	-
Mov Cap-1 Maneuver	-	-	1418	-	686
Mov Cap-2 Maneuver	-	-	-	-	686
Stage 1	-	-	-	-	870
Stage 2	-	-	-	-	879

Approach	EB	WB	NB
HCM Control Delay, s/v	0	0.28	9.72
HCM LOS			A

Minor Lane/Major Mvmt	NBLn1	EBT	EBR	WBL	WBT
Capacity (veh/h)	773	-	-	66	-
HCM Lane V/C Ratio	0.013	-	-	0.004	-
HCM Control Delay (s/veh)	9.7	-	-	7.5	0
HCM Lane LOS	A	-	-	A	A
HCM 95th %tile Q(veh)	0	-	-	0	-

Intersection						
Int Delay, s/veh	0.5					
Movement	EBT	EBR	WBL	WBT	NBL	NBR
Lane Configurations	h			4	Y	
Traffic Vol, veh/h	148	5	5	122	5	5
Future Vol, veh/h	148	5	5	122	5	5
Conflicting Peds, #/hr	0	0	0	0	0	0
Sign Control	Free	Free	Free	Free	Stop	Stop
RT Channelized	-	None	-	None	-	None
Storage Length	-	-	-	-	0	-
Veh in Median Storage, #	0	-	-	0	0	-
Grade, %	0	-	-	0	0	-
Peak Hour Factor	98	98	98	98	98	98
Heavy Vehicles, %	2	2	2	2	2	2
Mvmt Flow	151	5	5	124	5	5

Major/Minor	Major1	Major2	Minor1		
Conflicting Flow All	0	0	156	0	288
Stage 1	-	-	-	-	154
Stage 2	-	-	-	-	135
Critical Hdwy	-	-	4.12	-	6.42
Critical Hdwy Stg 1	-	-	-	-	5.42
Critical Hdwy Stg 2	-	-	-	-	5.42
Follow-up Hdwy	-	-	2.218	-	3.518
Pot Cap-1 Maneuver	-	-	1424	-	702
Stage 1	-	-	-	-	875
Stage 2	-	-	-	-	892
Platoon blocked, %	-	-	-	-	-
Mov Cap-1 Maneuver	-	-	1424	-	700
Mov Cap-2 Maneuver	-	-	-	-	700
Stage 1	-	-	-	-	875
Stage 2	-	-	-	-	888

Approach	EB	WB	NB
HCM Control Delay, s/v	0	0.3	9.65
HCM LOS			A

Minor Lane/Major Mvmt	NBLn1	EBT	EBR	WBL	WBT
Capacity (veh/h)	784	-	-	71	-
HCM Lane V/C Ratio	0.013	-	-	0.004	-
HCM Control Delay (s/veh)	9.7	-	-	7.5	0
HCM Lane LOS	A	-	-	A	A
HCM 95th %tile Q(veh)	0	-	-	0	-

Intersection						
Int Delay, s/veh	4.8					
Movement	WBL	WBR	NBT	NBR	SBL	SBT
Lane Configurations	↘		↗		↘	↗
Traffic Vol, veh/h	154	24	142	25	25	97
Future Vol, veh/h	154	24	142	25	25	97
Conflicting Peds, #/hr	0	0	0	0	0	0
Sign Control	Stop	Stop	Free	Free	Free	Free
RT Channelized	-	None	-	None	-	None
Storage Length	0	-	-	-	100	-
Veh in Median Storage, #	0	-	0	-	-	0
Grade, %	0	-	0	-	-	0
Peak Hour Factor	98	98	98	98	98	98
Heavy Vehicles, %	2	2	2	2	2	2
Mvmt Flow	157	24	145	26	26	99

Major/Minor	Minor1	Major1	Major2			
Conflicting Flow All	308	158	0	0	170	0
Stage 1	158	-	-	-	-	-
Stage 2	150	-	-	-	-	-
Critical Hdwy	6.42	6.22	-	-	4.12	-
Critical Hdwy Stg 1	5.42	-	-	-	-	-
Critical Hdwy Stg 2	5.42	-	-	-	-	-
Follow-up Hdwy	3.518	3.318	-	-	2.218	-
Pot Cap-1 Maneuver	685	888	-	-	1407	-
Stage 1	871	-	-	-	-	-
Stage 2	878	-	-	-	-	-
Platoon blocked, %			-	-		
Mov Cap-1 Maneuver	672	888	-	-	1407	-
Mov Cap-2 Maneuver	702	-	-	-	-	-
Stage 1	871	-	-	-	-	-
Stage 2	862	-	-	-	-	-

Approach	WB	NB	SB
HCM Control Delay, s/v	11.65	0	1.56
HCM LOS	B		

Minor Lane/Major Mvmt	NBT	NBRWBLn1	SBL	SBT
Capacity (veh/h)	-	-	722	1407
HCM Lane V/C Ratio	-	-	0.251	0.018
HCM Control Delay (s/veh)	-	-	11.6	7.6
HCM Lane LOS	-	-	B	A
HCM 95th %tile Q(veh)	-	-	1	0.1

Intersection						
Int Delay, s/veh	1.6					
Movement	WBL	WBR	NBT	NBR	SBL	SBT
Lane Configurations	↘		↗		↘	↗
Traffic Vol, veh/h	2	32	166	2	33	122
Future Vol, veh/h	2	32	166	2	33	122
Conflicting Peds, #/hr	0	0	0	0	0	0
Sign Control	Stop	Stop	Free	Free	Free	Free
RT Channelized	-	None	-	None	-	None
Storage Length	-	-	-	-	100	-
Veh in Median Storage, #	0	-	0	-	-	0
Grade, %	0	-	0	-	-	0
Peak Hour Factor	98	98	98	98	98	98
Heavy Vehicles, %	2	2	2	2	2	2
Mvmt Flow	2	33	169	2	34	124

Major/Minor	Minor1	Major1	Major2		
Conflicting Flow All	362	170	0	0	171
Stage 1	170	-	-	-	-
Stage 2	192	-	-	-	-
Critical Hdwy	6.42	6.22	-	-	4.12
Critical Hdwy Stg 1	5.42	-	-	-	-
Critical Hdwy Stg 2	5.42	-	-	-	-
Follow-up Hdwy	3.518	3.318	-	-	2.218
Pot Cap-1 Maneuver	637	873	-	-	1406
Stage 1	859	-	-	-	-
Stage 2	841	-	-	-	-
Platoon blocked, %			-	-	-
Mov Cap-1 Maneuver	622	873	-	-	1406
Mov Cap-2 Maneuver	666	-	-	-	-
Stage 1	859	-	-	-	-
Stage 2	821	-	-	-	-

Approach	WB	NB	SB
HCM Control Delay, s/v	9.37	0	1.62
HCM LOS	A		

Minor Lane/Major Mvmt	NBT	NBRWBLn1	SBL	SBT
Capacity (veh/h)	-	-	858	1406
HCM Lane V/C Ratio	-	-	0.04	0.024
HCM Control Delay (s/veh)	-	-	9.4	7.6
HCM Lane LOS	-	-	A	A
HCM 95th %tile Q(veh)	-	-	0.1	0.1

Intersection												
Int Delay, s/veh	6.1											
Movement	EBL	EBT	EBR	WBL	WBT	WBR	NBL	NBT	NBR	SBL	SBT	SBR
Lane Configurations		+			+		+	+		+	+	
Traffic Vol, veh/h	48	2	24	84	2	85	25	103	90	82	65	50
Future Vol, veh/h	48	2	24	84	2	85	25	103	90	82	65	50
Conflicting Peds, #/hr	0	0	0	0	0	0	0	0	0	0	0	0
Sign Control	Stop	Stop	Stop	Stop	Stop	Stop	Free	Free	Free	Free	Free	Free
RT Channelized	-	-	None	-	-	None	-	-	None	-	-	None
Storage Length	-	-	-	-	-	-	100	-	-	100	-	-
Veh in Median Storage, #	-	0	-	-	0	-	-	0	-	-	0	-
Grade, %	-	0	-	-	0	-	-	0	-	-	0	-
Peak Hour Factor	98	98	98	98	98	98	98	98	98	98	98	98
Heavy Vehicles, %	2	2	2	2	2	2	2	2	2	2	2	2
Mvmt Flow	49	2	24	86	2	87	26	105	92	84	66	51

Major/Minor	Minor2		Minor1		Major1		Major2					
Conflicting Flow All	416	507	92	437	487	151	117	0	0	197	0	0
Stage 1	259	259	-	202	202	-	-	-	-	-	-	-
Stage 2	157	248	-	235	285	-	-	-	-	-	-	-
Critical Hdwy	7.12	6.52	6.22	7.12	6.52	6.22	4.12	-	-	4.12	-	-
Critical Hdwy Stg 1	6.12	5.52	-	6.12	5.52	-	-	-	-	-	-	-
Critical Hdwy Stg 2	6.12	5.52	-	6.12	5.52	-	-	-	-	-	-	-
Follow-up Hdwy	3.518	4.018	3.318	3.518	4.018	3.318	2.218	-	-	2.218	-	-
Pot Cap-1 Maneuver	547	468	966	530	481	895	1471	-	-	1376	-	-
Stage 1	746	693	-	800	734	-	-	-	-	-	-	-
Stage 2	845	701	-	768	676	-	-	-	-	-	-	-
Platoon blocked, %								-	-	-	-	-
Mov Cap-1 Maneuver	454	432	966	475	444	895	1471	-	-	1376	-	-
Mov Cap-2 Maneuver	454	432	-	475	444	-	-	-	-	-	-	-
Stage 1	700	651	-	786	721	-	-	-	-	-	-	-
Stage 2	748	689	-	701	635	-	-	-	-	-	-	-

Approach	EB		WB		NB		SB	
HCM Control Delay, s/v	12.63		13.09		0.86		3.24	
HCM LOS	B		B					

Minor Lane/Major Mvmt	NBL	NBT	NBR	EBLn1	WBLn1	SBL	SBT	SBR
Capacity (veh/h)	1471	-	-	547	619	1376	-	-
HCM Lane V/C Ratio	0.017	-	-	0.138	0.282	0.061	-	-
HCM Control Delay (s/veh)	7.5	-	-	12.6	13.1	7.8	-	-
HCM Lane LOS	A	-	-	B	B	A	-	-
HCM 95th %tile Q(veh)	0.1	-	-	0.5	1.2	0.2	-	-

Intersection						
Int Delay, s/veh	2.3					
Movement	WBL	WBR	NBT	NBR	SBL	SBT
Lane Configurations	↘		↗		↘	↗
Traffic Vol, veh/h	28	28	207	29	75	169
Future Vol, veh/h	28	28	207	29	75	169
Conflicting Peds, #/hr	0	0	0	0	0	0
Sign Control	Stop	Stop	Free	Free	Free	Free
RT Channelized	-	None	-	None	-	None
Storage Length	0	-	-	-	100	-
Veh in Median Storage, #	0	-	0	-	-	0
Grade, %	0	-	0	-	-	0
Peak Hour Factor	98	98	98	98	98	98
Heavy Vehicles, %	2	2	2	2	2	2
Mvmt Flow	29	29	211	30	77	172

Major/Minor	Minor1	Major1	Major2		
Conflicting Flow All	552	226	0	0	241
Stage 1	226	-	-	-	-
Stage 2	326	-	-	-	-
Critical Hdwy	6.42	6.22	-	-	4.12
Critical Hdwy Stg 1	5.42	-	-	-	-
Critical Hdwy Stg 2	5.42	-	-	-	-
Follow-up Hdwy	3.518	3.318	-	-	2.218
Pot Cap-1 Maneuver	495	813	-	-	1326
Stage 1	812	-	-	-	-
Stage 2	732	-	-	-	-
Platoon blocked, %			-	-	-
Mov Cap-1 Maneuver	466	813	-	-	1326
Mov Cap-2 Maneuver	549	-	-	-	-
Stage 1	812	-	-	-	-
Stage 2	690	-	-	-	-

Approach	WB	NB	SB
HCM Control Delay, s/v11.01		0	2.42
HCM LOS	B		

Minor Lane/Major Mvmt	NBT	NBRWBLn1	SBL	SBT
Capacity (veh/h)	-	-	656	1326
HCM Lane V/C Ratio	-	-	0.087	0.058
HCM Control Delay (s/veh)	-	-	11	7.9
HCM Lane LOS	-	-	B	A
HCM 95th %tile Q(veh)	-	-	0.3	0.2

HCM Unsignalized Intersection Capacity Analysis
 15: Access 8 & Oldham Parkway

Future Conditions Traffic Volumes
 SAT Peak Hour



Movement	EBT	EBR	WBL	WBT	NBL	NBR	
Lane Configurations	↑↑↑↑			↑↑		↗	
Traffic Volume (veh/h)	842	12	0	865	0	56	
Future Volume (Veh/h)	842	12	0	865	0	56	
Sign Control	Free			Free	Stop		
Grade	0%			0%	0%		
Peak Hour Factor	0.98	0.98	0.98	0.98	0.98	0.98	
Hourly flow rate (vph)	859	12	0	883	0	57	
Pedestrians							
Lane Width (ft)							
Walking Speed (ft/s)							
Percent Blockage							
Right turn flare (veh)							
Median type	None			None			
Median storage veh)							
Upstream signal (ft)	1111			281			
pX, platoon unblocked							
vC, conflicting volume			871	1307	221		
vC1, stage 1 conf vol							
vC2, stage 2 conf vol							
vCu, unblocked vol			871	1307	221		
tC, single (s)			4.1	6.8	6.9		
tC, 2 stage (s)							
tF (s)			2.2	3.5	3.3		
p0 queue free %			100	100	93		
cM capacity (veh/h)			770	151	783		
Direction, Lane #	EB 1	EB 2	EB 3	EB 4	WB 1	WB 2	NB 1
Volume Total	245	245	245	135	442	442	57
Volume Left	0	0	0	0	0	0	0
Volume Right	0	0	0	12	0	0	57
cSH	1700	1700	1700	1700	1700	1700	783
Volume to Capacity	0.14	0.14	0.14	0.08	0.26	0.26	0.07
Queue Length 95th (ft)	0	0	0	0	0	0	6
Control Delay (s/veh)	0.0	0.0	0.0	0.0	0.0	0.0	10.0
Lane LOS							A
Approach Delay (s/veh)	0.0			0.0			10.0
Approach LOS							A
Intersection Summary							
Average Delay			0.3				
Intersection Capacity Utilization			27.2%		ICU Level of Service		A
Analysis Period (min)			15				

Appendix F: Signal Warrant Analysis

Figure 4C-3. Warrant 3, Peak Hour

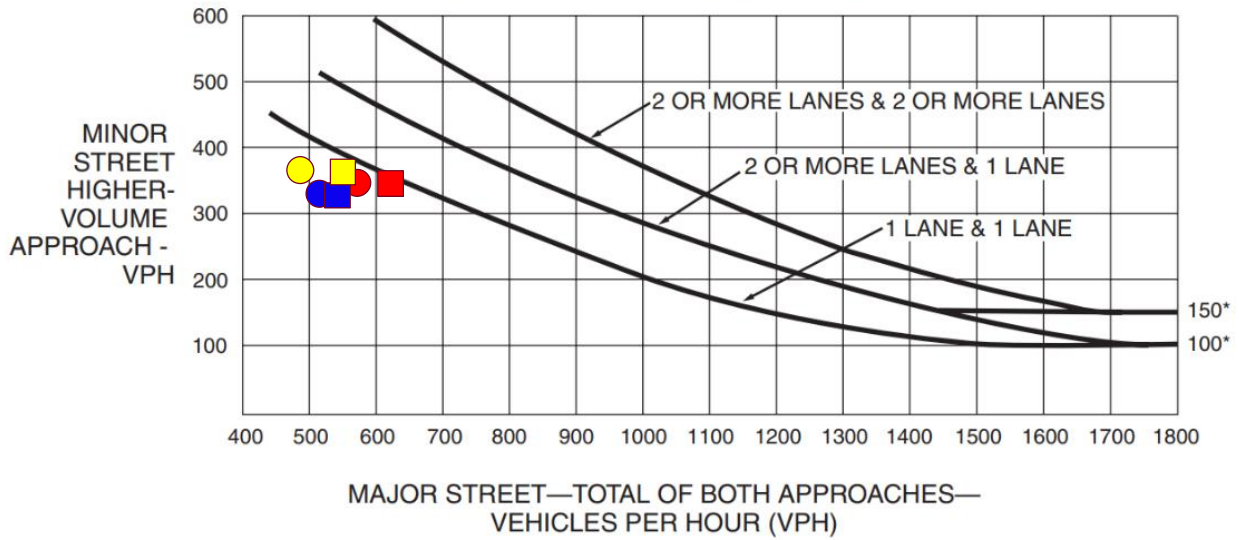

*Note: 150 vph applies as the lower threshold volume for a minor-street approach with two or more lanes and 100 vph applies as the lower threshold volume for a minor-street approach with one lane.

Peak Hour Signal Warrant Analysis – Oldham Parkway & Access 2

Peak Hour	Major Street Volume	Minor Street Higher Volume Approach
Existing + Phase 1 Development		
● AM	589	325
● PM	508	313
● SAT	499	352
Existing + Full Development		
■ AM	608	325
■ PM	523	313
■ SAT	524	352

Figure 4C-1. Warrant 2, Four-Hour Vehicular Volume

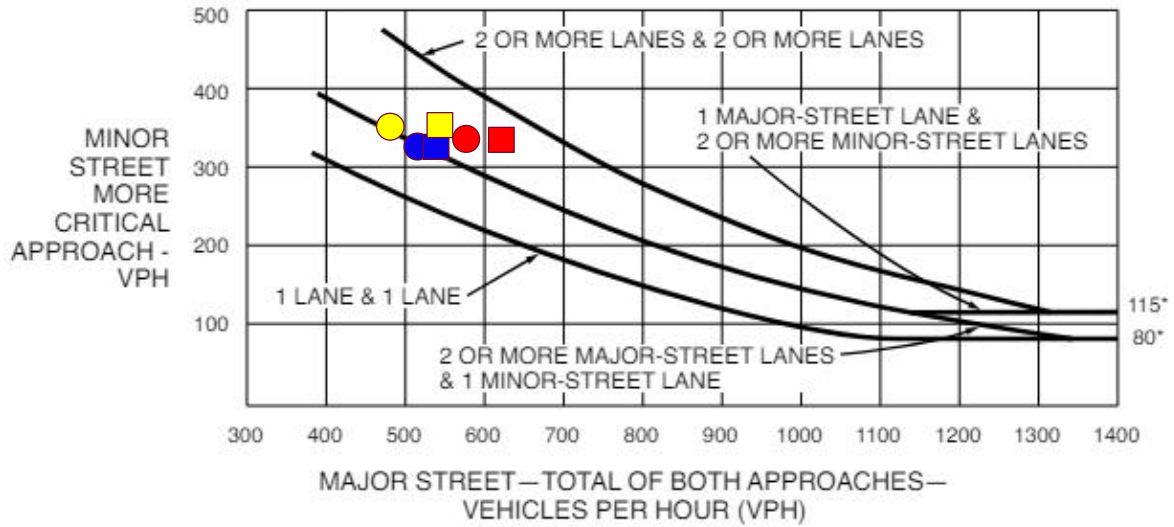

*Note: 115 vph applies as the lower threshold volume for a minor-street approach with two or more lanes and 80 vph applies as the lower threshold volume for a minor-street approach with one lane

Four Hour Signal Warrant Analysis – Oldham Parkway & Access 2

Peak Hour	Major Street Volume	Minor Street Higher Volume Approach
Existing + Phase 1 Development		
● AM	589	325
● PM	508	313
● SAT	499	352
Existing + Full Development		
■ AM	608	325
■ PM	523	313
■ SAT	524	352