

WATER LINE PLANS FOR MANOR AT BAILEY FARMS, FIRST PLAT IN THE CITY OF LEE'S SUMMIT JACKSON COUNTY, MISSOURI

LEGEND:

- A/E - ACCESS EASEMENT
- BC - BACK OF CURB
- B/B - BACK TO BACK
- BM - BENCHMARK
- BL or B.L. - BUILDING LINE
- CO - CLEANOUT
- TJB - TELEPHONE JUNCTION BOX
- C&G - CURB AND GUTTER
- D/E - DRAINAGE EASEMENT
- E/E - ELECTRICAL EASEMENT
- EL - ELEVATION
- FL - FLOW LINE
- G/E - GAS LINE EASEMENT
- HDPE - HIGH-DENSITY POLYETHYLENE
- L/E - LANDSCAPE EASEMENT
- MSFE - MINIMUM SERVICEABLE FLOOR ELEVATION
- PVC - POLYVINYL CHLORIDE
- P/L - PROPERTY LINE
- PUB/E - PUBLIC EASEMENT
- RCP - REINFORCED CONCRETE PIPE
- ROW or RW - RIGHT-OF-WAY
- S/E - SANITARY SEWER EASEMENT
- SL - SERVICE LINE
- S/W - SIDEWALK
- TE - TOP ELEVATION
- U/E - UTILITY EASEMENT
- WSE - WATER SURFACE ELEVATION
- W/E - WATERLINE EASEMENT

- ASPHALT PAVEMENT - EXISTING
- ASPHALT PAVEMENT - PROPOSED
- CONCRETE PAVEMENT - EXISTING
- CONCRETE PAVEMENT - PROPOSED
- CONCRETE SIDEWALK - EXISTING
- CONCRETE SIDEWALK - PROPOSED
- CURB & GUTTER
- CURB & GUTTER - EXISTING
- TREELINE
- EXISTING LOT AND R/W LINES
- EXISTING PLAT LINES
- P/L PROPERTY LINES
- ROW RIGHT-OF-WAY
- SANITARY SEWER MAIN
- SANITARY SEWER MAIN - EXIST.
- STO STORM SEWER
- STORM SEWER - EXISTING
- CATV_x CABLE TV - EXISTING
- FOC_x FIBER OPTIC CABLE - EXISTING
- T_x TELEPHONE LINE - EXIST.
- E_x ELECTRIC LINE - EXISTING
- OHP_x OVERHEAD POWER LINE - EXIST.
- UG_x UNDERGROUND ELECTRIC - EX.
- G_x GAS LINE - EXISTING
- WATERLINE
- WATERLINE - EXISTING
- LIGHT - EXISTING
- EXISTING MANHOLE
- CLEANOUT
- EXISTING SANITARY MANHOLE
- PROPOSED SANITARY MANHOLE
- AI EXISTING AREA INLET
- CI EXISTING CURB INLET
- GI EXISTING GRATE INLET
- JB EXISTING JUNCTION BOX
- SM EXISTING STORM MANHOLE

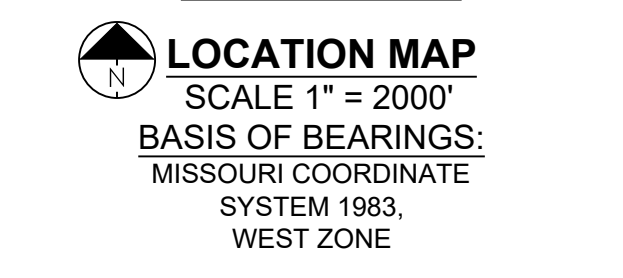
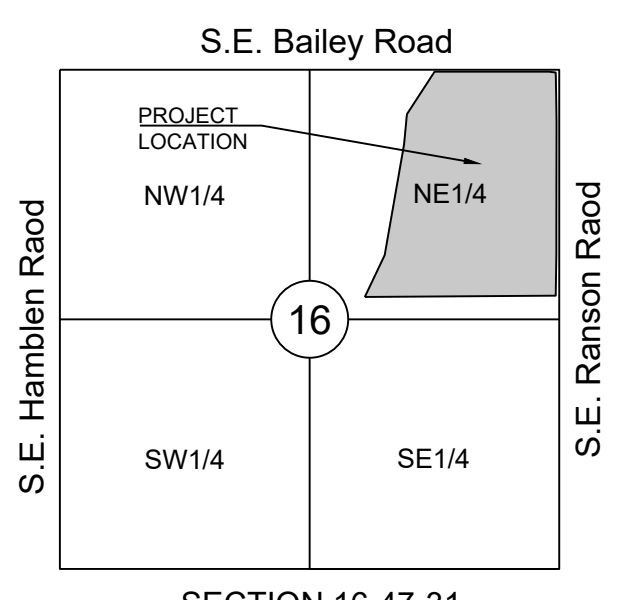

UTILITY CONTACTS:

MISSOURI DEPARTMENT OF TRANSPORTATION (MODOT)
Steve Holloway
600 NE Colbern Road
Lee's Summit, MO 64086
(816) 607-2186

MISSOURI GAS ENERGY (MGE)
Brent Jones
3025 SE Clover Drive
Lee's Summit, MO 64082
(816) 399-9633
brent.jones@spireenergy.com

KANSAS CITY POWER & LIGHT COMPANY (KCP&L)
Ron DeJarnette
1300 SE Hamblen Road
Lee's Summit, MO 64081
Office: (816) 347-4316
Cell: (816) 810-5234
ron.dejarnette@kcp.com

CITY OF LEES SUMMIT PUBLIC WORKS
Dena Mezger
220 SE Green Street
Lee's Summit, MO 64063
(816) 969-1800

AT&T
Mark Manion or Marty Loper
500 E. 8th Street, Room 370
Kansas City, MO 64106
(816) 275-2341 or (816) 275-1550

COMCAST CABLE
John Meadows
4700 Little Blue Parkway
Independence, MO 64057
(816) 795-2257

CITY OF LEE'S SUMMIT WATER UTILITIES
Mark Schaufier
1200 SE Hamblen Road
Lee's Summit, MO 64081
(816) 969-1900

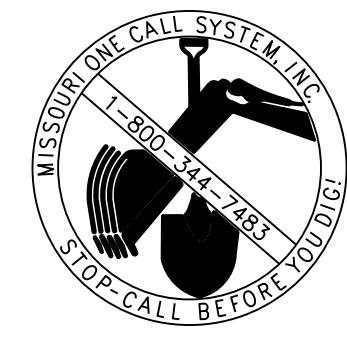

GENERAL NOTES:

1. ALL CONSTRUCTION TO FOLLOW THE CITY OF LEE'S SUMMIT DESIGN AND CONSTRUCTION MANUAL AS ADOPTED BY ORDINANCE 5813.
2. ALL WORKMANSHIP AND MATERIALS SHALL BE SUBJECT TO THE INSPECTION AND APPROVAL OF THE ENGINEERING DEPARTMENT OF THE CITY OF LEE'S SUMMIT, MISSOURI.
3. LINEAL FOOT MEASUREMENTS SHOWN ON THE PLANS ARE HORIZONTAL MEASUREMENTS, NOT SLOPE MEASUREMENTS. ALL PAYMENTS SHALL BE MADE ON HORIZONTAL MEASUREMENTS.
4. NO GEOLOGICAL INVESTIGATION HAS BEEN PERFORMED ON THE SITE.
5. THE UTILITY LOCATIONS SHOWN ON THESE PLANS ARE TAKEN FROM UTILITY COMPANY RECORDS AND APPARENT FIELD LOCATIONS. THE CONTRACTOR SHALL VERIFY THE LOCATION AND DEPTH OF ALL UTILITIES PRIOR TO CONSTRUCTION.
6. THE CONTRACTOR SHALL ADHERE TO THE PROVISIONS OF THE SENATE BILL NUMBER 583, 78TH GENERAL ASSEMBLY OF THE STATE OF MISSOURI. THE BILL REQUIRES THAT ANY PERSON OR FIRM DOING EXCAVATION ON PUBLIC RIGHT OF WAY DO SO ONLY AFTER GIVING NOTICE TO, AND OBTAINING INFORMATION FROM, UTILITY COMPANIES. STATE LAW REQUIRES 48 HOURS ADVANCE NOTICE. THE CONTRACTOR MAY ALSO UTILIZE THE FOLLOWING TOLL FREE PHONE NUMBER PROVIDED BY "MISSOURI ONE CALL SYSTEM, INC.": 1-800-DIG-RITE. THIS PHONE NUMBER IS APPLICABLE ANYWHERE WITHIN THE STATE OF MISSOURI. PRIOR TO COMMENCEMENT OF WORK, THE CONTRACTOR SHALL NOTIFY ALL THOSE COMPANIES WHICH HAVE FACILITIES IN THE NEAR VICINITY OF THE CONSTRUCTION TO BE PERFORMED.
7. PRIOR TO ORDERING PRECAST STRUCTURES, SHOP DRAWING SHALL BE SUBMITTED TO THE DESIGN ENGINEER FOR APPROVAL.
8. THE CONTRACTOR SHALL PROTECT ALL MAJOR TREES FROM DAMAGE. NO TREE SHALL BE REMOVED WITHOUT PERMISSION OF THE OWNER, UNLESS SHOWN OTHERWISE.
9. CLEARING AND GRUBBING OPERATIONS AND DISPOSAL OF ALL DEBRIS THEREFROM SHALL BE PERFORMED BY THE CONTRACTOR IN STRICT ACCORDANCE WITH ALL LOCAL CODES AND ORDINANCES.
10. ALL WASTE MATERIAL RESULTING FROM THE PROJECT SHALL BE DISPOSED OF OFF-SITE BY THE CONTRACTOR, OR AS DIRECTED BY THE OWNER AT NO ADDITIONAL COST.
11. ALL EXCAVATIONS SHALL BE UNCLASSIFIED. NO SEPARATE PAYMENT WILL BE MADE FOR ROCK EXCAVATION.
12. THE CONTRACTOR SHALL CONTROL THE EROSION AND SILTATION DURING ALL PHASES OF CONSTRUCTION AND SHALL KEEP THE STREETS CLEAN OF MUD AND DEBRIS.
13. THE CONTRACTOR SHALL CONTACT DEVELOPMENT SERVICES INSPECTIONS AT: 816-969-1800 TO OBTAIN A DEVELOPMENT SERVICES CONSTRUCTION PERMIT. A MINIMUM 48 HOUR NOTICE SHALL BE GIVEN PRIOR TO PERMIT ISSUANCE.
14. THE CONTRACTOR SHALL CONTACT THE RIGHT OF WAY INSPECTOR AT 816-969-1800 PRIOR TO ANY LAND DISTURBANCE ACTIVITIES WITHIN THE RIGHT OF WAY. THESE ACTIVITIES MAY REQUIRE A PERMIT.
15. THE CONTRACTOR SHALL PROVIDE AND MAINTAIN ALL TRAFFIC HANDLING MEASURES NECESSARY TO ENSURE THAT THE GENERAL PUBLIC IS PROTECTED AT ALL TIMES. TRAFFIC CONTROL SHALL CONFORM TO THE MANUAL ON UNIFORM TRAFFIC CONTROL DEVICES (MUTCD-LATEST EDITION).
16. ALL SANITARY SEWER LATERALS SHALL HAVE A TRENCH CHECK, CONSISTING OF FLOWABLE BACKFILL, INSTALLED DURING CONSTRUCTION. TRENCH CHECK SHALL EXTEND TO BOTTOM OF TRENCH, TO WIDTH OF TRENCH, TO 12 INCHES ABOVE PIPE, FOR A MINIMUM LENGTH OF 12 INCHES. TRENCH CHECK SHALL BE LOCATED AT LEAST 5 FEET FROM SANITARY MAIN.

EARTHWORK:

1. PRIOR TO EARTHWORK ACTIVITIES, PRE-DISTURBANCE EROSION AND SEDIMENT CONTROL DEVICES SHALL BE IN PLACE PER THE STORM WATER POLLUTION PREVENTION PLAN AND/OR THE EROSION AND SEDIMENT CONTROL PLAN PREPARED FOR THIS SITE.
2. ALL BACKFILL MATERIAL SHALL BE PLACED IN MAXIMUM 6-INCH LIFTS AND COMPACTED TO 95-PERCENT OF MAXIMUM DENSITY AS DEFINED USING A STANDARD PROCTOR TEST (AASHTO T99/ASTM 698).
3. BACKFILL MATERIALS SHALL NOT INCLUDE ORGANIC MATTER, DEBRIS OR TOPSOIL.
4. THE CONTRACTOR SHALL BE RESPONSIBLE FOR REDISTRIBUTING THE TOPSOIL OVER PROPOSED TURF AND LANDSCAPED AREAS TO A MINIMUM DEPTH OF 6-INCHES BELOW FINAL GRADE.
5. ALL AREAS SHALL BE GRADED FOR POSITIVE DRAINAGE. UNLESS NOTED OTHERWISE THE FOLLOWING GRADES SHALL APPLY:
 - A. TURF AREAS - 2.5% MINIMUM, 4H:1V MAXIMUM
6. ALL DISTURBED AREAS SHALL BE FERTILIZED, SEEDED AND MULCHED IMMEDIATELY AFTER EXCAVATION ACTIVITIES HAVE CEASED. SEEDING SHALL BE PER APWA SECTION 2400, LATEST EDITION, UNLESS OTHERWISE NOTED. SEEDING SHALL BE SUBSIDIARY TO THE CONTRACT PRICE FOR PIPE INSTALLATION.
7. CONTRACTOR SHALL ADHERE TO THE REPORTING REQUIREMENTS OUTLINED IN THE STORM WATER POLLUTION PREVENTION PLAN (SWPPP) PREPARED FOR THIS PROJECT. EROSION AND SEDIMENT CONTROL DEVICES SHALL BE PROPERLY MAINTAINED AND KEPT CLEAN OF SILT AND DEBRIS AND IN GOOD WORKING ORDER. ADDITIONAL EROSION AND SEDIMENT CONTROL MEASURES SHALL BE INSTALLED AS REQUIRED.

UTILITIES:

1. EXISTING UTILITIES HAVE BEEN SHOWN TO THE GREATEST EXTENT POSSIBLE BASED UPON INFORMATION PROVIDED TO THE ENGINEER. THE CONTRACTOR IS RESPONSIBLE FOR CONTACTING THE RESPECTIVE UTILITY COMPANIES AND FIELD LOCATING UTILITIES PRIOR TO CONSTRUCTION AND IDENTIFYING ANY POTENTIAL CONFLICTS. ALL CONFLICTS SHALL IMMEDIATELY BE BROUGHT TO THE ATTENTION OF THE ENGINEER.
2. THE CONTRACTOR SHALL BE RESPONSIBLE FOR COORDINATING ANY REQUIRED UTILITY RELOCATIONS. UTILITIES DAMAGED THROUGH THE NEGLIGENCE OF THE CONTRACTOR SHALL BE REPAIRED AT THE CONTRACTOR'S EXPENSE.
3. CONTRACTOR SHALL VERIFY FLOW-LINES AND STRUCTURE TOPS PRIOR TO CONSTRUCTION, AND SHALL NOTIFY ENGINEER OF ANY DISCREPANCIES. PROVIDE SHOP DRAWINGS FOR ALL PRECAST AND MANUFACTURED UTILITY STRUCTURES FOR REVIEW BY THE ENGINEER PRIOR TO CONSTRUCTION OF THE STRUCTURES.
4. UTILITY SEPARATION: WATERLINES SHALL HAVE A MINIMUM OF 10 FEET HORIZONTAL AND 2 FEET VERTICAL SEPARATION FROM ALL SANITARY AND STORM SEWER LINES. IF MINIMUM SEPARATIONS CAN NOT BE OBTAINED, DUCTILE IRON PIPE, DIP, SHALL BE REQUIRED 10 FEET IN EACH DIRECTION OF THE CONFLICT ON THE WATER LINE.
5. PAYMENT FOR TRENCHING, BACKFILLING, PIPE EMBEDMENT, FLOWABLE FILL, BACKFILL MATERIALS, CLEAN UP, SEEDING, SODDING AND ANY OTHER ITEMS NECESSARY FOR THE CONSTRUCTION OF THE UTILITY LINE SHALL BE INCLUDED IN THE CONTRACT PRICE FOR THE UTILITY INSTALLATION.
6. THE CONTRACTOR SHALL BE RESPONSIBLE FOR CONTACTING RESPECTIVE UTILITY COMPANIES 48-HOURS IN ADVANCE FOR THE INSPECTION OF ANY PROPOSED UTILITY MAIN EXTENSION OR SERVICE LINE OR SERVICE CONNECTION TO ANY EXISTING MAIN.
7. TRENCH SPOILS SHALL BE NEATLY PLACED ONSITE ADJACENT TO THE TRENCH, AND COMPACTED TO PREVENT SATURATION AND EXCESS SEDIMENT RUNOFF. UNSUITABLE MATERIALS, ROCK AND SHALE, ASPHALT, CONCRETE, TREES, BRUSH ETC. SHALL BE PROPERLY DISPOSED OF OFFSITE. MATERIALS MAY BE WASTED ONSITE AT THE DIRECTION OF THE OWNER OR HIS APPOINTED REPRESENTATIVE.

Sheet List Table	
Sheet Number	Sheet Title
1	COVER SHEET
2	GENERAL LAYOUT - NORTH
3	GENERAL LAYOUT - WEST
4	GENERAL LAYOUT - EAST
5	WATER LINE 1 PLAN & PROFILE
6	WATER LINE 1 PLAN & PROFILE CONT'D
7	WATER LINE 2 PLAN & PROFILE
8	WATER LINE 2 PLAN & PROFILE CONT'D
9	WATER LINE 3 PLAN & PROFILE
10	WATER LINE 3 PLAN & PROFILE CONT'D
11	WATER LINE 4 PLAN & PROFILE
12	WATER LINE 5 PLAN & PROFILE
13	WATER LINE 8, 10, & 12 PLAN & PROFILE
14	WATER LINE 13 PLAN & PROFILE
15	WATER LINE DETAILS



PREPARED BY:



6/30/2022
SCHLAGEL & ASSOCIATES, P.A.

MANOR AT BAILEY FARMS, FIRST PLAT
WATER LINE PLANS
SE BAILEY ROAD AND SE RANSON ROAD
LEE'S SUMMIT, MISSOURI

APPROVED BY:

CITY ENGINEER _____ DATE _____
APPROVED FOR ONE YEAR FROM THIS DATE

OWNER/DEVELOPER:

CLAYTON PROPERTIES GROUP, INC., DBA SUMMIT HOMES
DBA SUMMIT HOMES
BRADLEY KEMPF
120 SE 30TH STREET
LEE'S SUMMIT, MO 64082
p (816) 246-6700

SUMMARY OF QUANTITIES			
	ITEM	QUANTITY	UNITS
1	CONNECT TO EXISTING WATER LINE	2	EA
2	DRY BORE	40	LF
3	FIRE HYDRANT ASSEMBLY	15	EA
4	END OF LINE TEMPORARY FIRE HYDRANT ASSEMBLY	12	EA
5	8" C-900 PVC	7,586	LF
6	8" GATE VALVE	24	EA
7	8" X 8" TEE	7	EA
8	16" BUTTERFLY VALVE	1	EA
9	8" X 8" CROSS	7	EA
10	8" 11.25" PVC BEND	28	EA
11	8" 22.5" PVC BEND	3	EA
12	8" 45" PVC BEND	17	EA
	SUBSIDIARY TO BENDS, TEES, ETC. IS ALL REQUIRED BLOCKING		

MISSOURI GEOGRAPHIC REFERENCE SYSTEM BENCHMARK:

BM JA-45, IS A KC METRO ALUMINUM GRS DISK SET IN CONCRETE AND ABOUT 3 INCHES BELOW THE PAVEMENT ON THE SHOULDER OF SE RANSON ROAD. IT IS STAMPED JA45, 1987.

ELEV. = 1046.25

PROJECT BENCHMARK:

Brass Disk at the Northeast Corner of the Northeast One-Quarter of Section 16, Township 47 N, Range 31 W, Intersection of SE, Bailey Road and SE, Ranson Road.

ELEV. = 939.19

REVISION DATE	DESCRIPTION
01/24/2022	Per City Comments dated 11/19/2022
04/20/2022	Per City Comments dated 02/15/2022
05/03/2022	Per City Comments dated 05/24/2022
06/30/2022	Per City Comments dated 05/31/2022

DRAWN BY: MBH	CHECKED BY: JLL	DATE PREPARED: 11/05/2021	PROJ. NUMBER: 21-130
---------------	-----------------	---------------------------	----------------------

COVER SHEET

SHEET

I:\PROJECTS\2021\21-130\3.0 Design\3.0 DWG Plans\3.0 DWG Plans\8.0 Water\21-130_COV.dwg, 6/30/2022 6:35:24 AM, 1:1

PREPARED BY:



6/30/2022
 SCHLAGEL & ASSOCIATES, P.A.

MANOR AT BAILEY FARMS, FIRST PLAT
WATER LINE PLANS
SE BAILEY ROAD AND SE RANSON ROAD
LEE'S SUMMIT, MISSOURI

REVISION DATE	DESCRIPTION
01/24/2022	Per City Comments dated 11/19/2022
04/20/2022	Per City Comments dated 02/15/2022
05/03/2022	Per City Comments dated 05/24/2022
06/30/2022	Per City Comments dated 05/31/2022

GENERAL LAYOUT - NORTH

SHEET

2

NOTES:

1. ALL CONSTRUCTION TO FOLLOW THE CITY OF LEE'S SUMMIT DESIGN AND CONSTRUCTION MANUAL AS ADOPTED BY ORDINANCE 5813.
2. THE CONTRACTOR IS RESPONSIBLE FOR VERIFYING ALL EXISTING UTILITY LOCATIONS PRIOR TO EXCAVATION.
3. FOR ALL WATER LINES THE MAXIMUM DEPTH OF COVER IS SEVEN (7) FEET.

MISSOURI GEOGRAPHIC REFERENCE SYSTEM BENCHMARK:

BM JA-45, IS A KC METRO ALUMINUM GRS DISK SET IN CONCRETE AND ABOUT 3 INCHES BELOW THE PAVEMENT ON THE SHOULDER OF SE RANSON ROAD. IT IS STAMPED JA45, 1987.
 ELEV. = 1046.25

BASIS OF BEARINGS:

MISSOURI STATE PLANE COORDINATE SYSTEM (NAD) 1983, MISSOURI, WEST ZONE

NW CORNER, NE. 1/4, SECTION 16, 47N, 31W

NE CORNER, NE. 1/4, SECTION 16, 47N, 31W



I:\PROJECTS\2021\21-130\3.0 Design\3.0 DWG Plans\8.0 Water\21-130-WATER_GEN.dwg, 6/30/2022 6:36:20 AM, 11



MISSOURI GEOGRAPHIC REFERENCE SYSTEM BENCHMARK:

BM JA-45, IS A KC METRO ALUMINUM GRS DISK SET IN CONCRETE AND ABOUT 3 INCHES BELOW THE PAVEMENT ON THE SHOULDER OF SE RANSON ROAD. IT IS STAMPED JA45, 1987.

ELEV. = 1046.25

BASIS OF BEARINGS:

MISSOURI STATE PLANE COORDINATE SYSTEM (NAD) 1983, MISSOURI, WEST ZONE

NOTES:

1. ALL CONSTRUCTION TO FOLLOW THE CITY OF LEE'S SUMMIT DESIGN AND CONSTRUCTION MANUAL AS ADOPTED BY ORDINANCE 5813.
2. THE CONTRACTOR IS RESPONSIBLE FOR VERIFYING ALL EXISTING UTILITY LOCATIONS PRIOR TO EXCAVATION.
3. FOR ALL WATER LINES THE MAXIMUM DEPTH OF COVER IS SEVEN (7) FEET.

SCHLAGEL
 ENGINEERS PLANNERS SURVEYORS LANDSCAPE ARCHITECTS
 14920 West 107th Street • Lenexa, Kansas 66215
 (913) 492-5158 • Fax: (913) 492-8400
 WWW.SCHLAGELASSOCIATES.COM
 Missouri State Certificates of Authority
 #E2002003600F #LAC2001005237 #LS2002008659F

PREPARED BY:



6/30/2022

SCHLAGEL & ASSOCIATES, P.A.

**MANOR AT BAILEY FARMS, FIRST PLAT
 WATER LINE PLANS
 SE BAILEY ROAD AND SE RANSON ROAD
 LEE'S SUMMIT, MISSOURI**

REVISION DATE	DESCRIPTION
01/24/2022	Per City Comments dated 11/19/2022
04/20/2022	Per City Comments dated 02/15/2022
05/31/2022	Per City Comments dated 05/24/2022
06/30/2022	Per City Comments dated 05/31/2022

GENERAL LAYOUT - WEST

SHEET

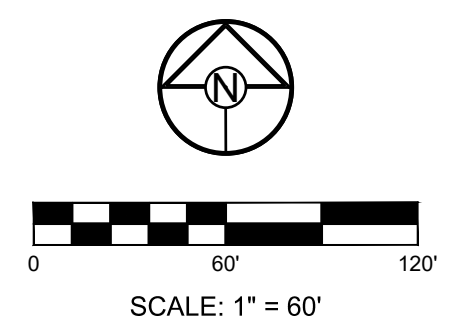

I:\PROJECTS\2021\21-130-0 Design\3.0 DWG Plans\8.0 Water\21-130-WATER GEN.dwg, 6/30/2022 6:36:25 AM, 1:1



MISSOURI GEOGRAPHIC REFERENCE SYSTEM BENCHMARK:

BM JA-45, IS A KC METRO ALUMINUM GRS DISK SET IN CONCRETE AND ABOUT 3 INCHES BELOW THE PAVEMENT ON THE SHOULDER OF SE RANSON ROAD. IT IS STAMPED JA45, 1987.

ELEV. = 1046.25

BASIS OF BEARINGS:

MISSOURI STATE PLANE COORDINATE SYSTEM (NAD) 1983, MISSOURI, WEST ZONE

NOTES:

1. ALL CONSTRUCTION TO FOLLOW THE CITY OF LEE'S SUMMIT DESIGN AND CONSTRUCTION MANUAL AS ADOPTED BY ORDINANCE 5813.
2. THE CONTRACTOR IS RESPONSIBLE FOR VERIFYING ALL EXISTING UTILITY LOCATIONS PRIOR TO EXCAVATION.
3. FOR ALL WATER LINES THE MAXIMUM DEPTH OF COVER IS SEVEN (7) FEET.

SCHLAGEL
 ENGINEERS PLANNERS SURVEYORS LANDSCAPE ARCHITECTS
 14920 West 107th Street • Lenexa, Kansas 66215
 (913) 492-5158 • Fax: (913) 492-8400
 WWW.SCHLAGELASSOCIATES.COM
 Missouri State Certificates of Authority
 #E2002003690-F #LAC2001005237 #LS200200895-F

PREPARED BY:



6/30/2022
 SCHLAGEL & ASSOCIATES, P.A.

**MANOR AT BAILEY FARMS, FIRST PLAT
 WATER LINE PLANS
 SE BAILEY ROAD AND SE RANSON ROAD
 LEE'S SUMMIT, MISSOURI**

REVISION DATE	DESCRIPTION
01/24/2022	Per City Comments dated 11/19/2022
04/20/2022	Per City Comments dated 02/15/2022
05/31/2022	Per City Comments dated 05/24/2022
6/30/2022	Per City Comments dated 05/31/2022

GENERAL LAYOUT - EAST

SHEET
4

I:\PROJECTS\2021\21-130\3.0 Design\3.0 DWG Plans\8.0 Water\21-130-WATER_GEN.dwg, 6/30/2022 6:36:35 AM, 1:1

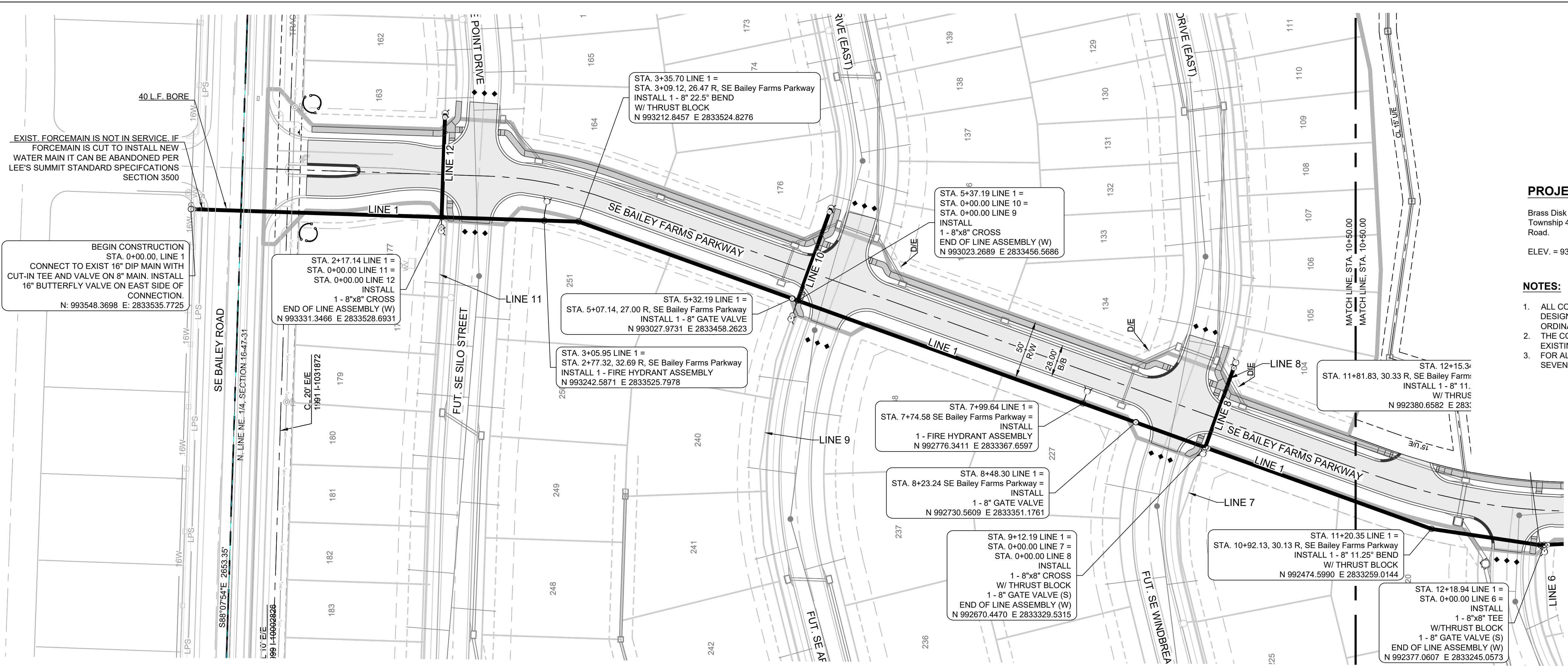

PROJECT BENCHMARK:
 Brass Disk at the Northeast Corner of the Northeast One-Quarter of Section 16,
 Township 47 N, Range 31 W, Intersection of SE. Bailey Road and SE. Ranson
 Road.
 ELEV. = 939.19

- NOTES:**
- ALL CONSTRUCTION TO FOLLOW THE CITY OF LEE'S SUMMIT DESIGN AND CONSTRUCTION MANUAL AS ADOPTED BY ORDINANCE 5813.
 - THE CONTRACTOR IS RESPONSIBLE FOR VERIFYING ALL EXISTING UTILITY LOCATIONS PRIOR TO EXCAVATION.
 - FOR ALL WATER LINES THE MAXIMUM DEPTH OF COVER IS SEVEN (7) FEET.

SCHLAGEL
 ENGINEERS PLANNERS SURVEYORS LANDSCAPE ARCHITECTS
 14920 West 107th Street • Lenexa, Kansas 66215
 (913) 492-5158 • Fax: (913) 492-8400
 WWW.SCHLAGELASSOCIATES.COM
 Missouri State Certificates of Authority
 #E2002003600F #LAC201005237 #S200200899F

PREPARED BY:

 JAMES L. LONG
 NUMBER PE-30468985
 6/30/2022
 SCHLAGEL & ASSOCIATES, P.A.

MANOR AT BAILEY FARMS, FIRST PLAT
WATER LINE PLANS
SE BAILEY ROAD AND SE RANSON ROAD
LEE'S SUMMIT, MISSOURI

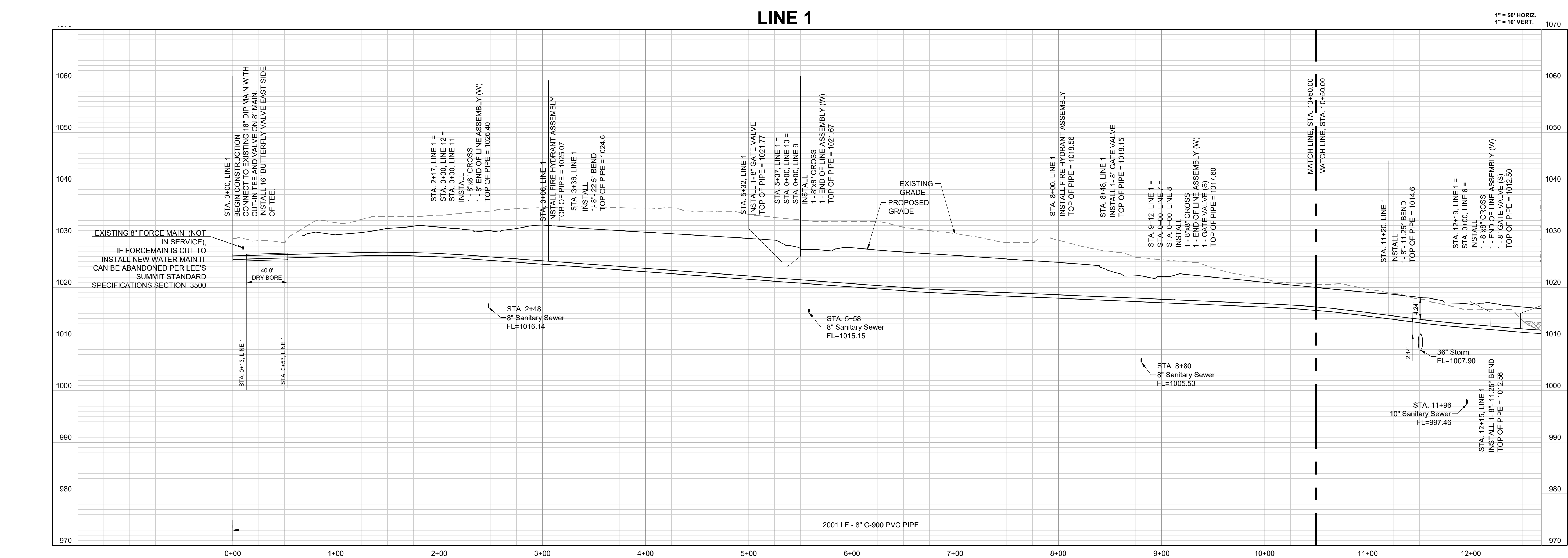

REVISION DATE	DESCRIPTION
01/24/2022	Per City Comments dated 11/19/2022
04/20/2022	Per City Comments dated 02/15/2022
05/31/2022	Per City Comments dated 05/24/2022
6/30/2022	Per City Comments dated 05/31/2022

DRAWN BY:	MBH
CHECKED BY:	JLL
DATE PREPARED:	11/05/2021
PROJ. NUMBER:	21-130

WATER LINE 1
PLAN & PROFILE

SHEET
5

I:\PROJECTS\2021\21-130\0 Design\3.0 DWG Plans\8.0 Water\21-130-WATER P&P.dwg, 6/30/2022 6:51:09 AM, 11

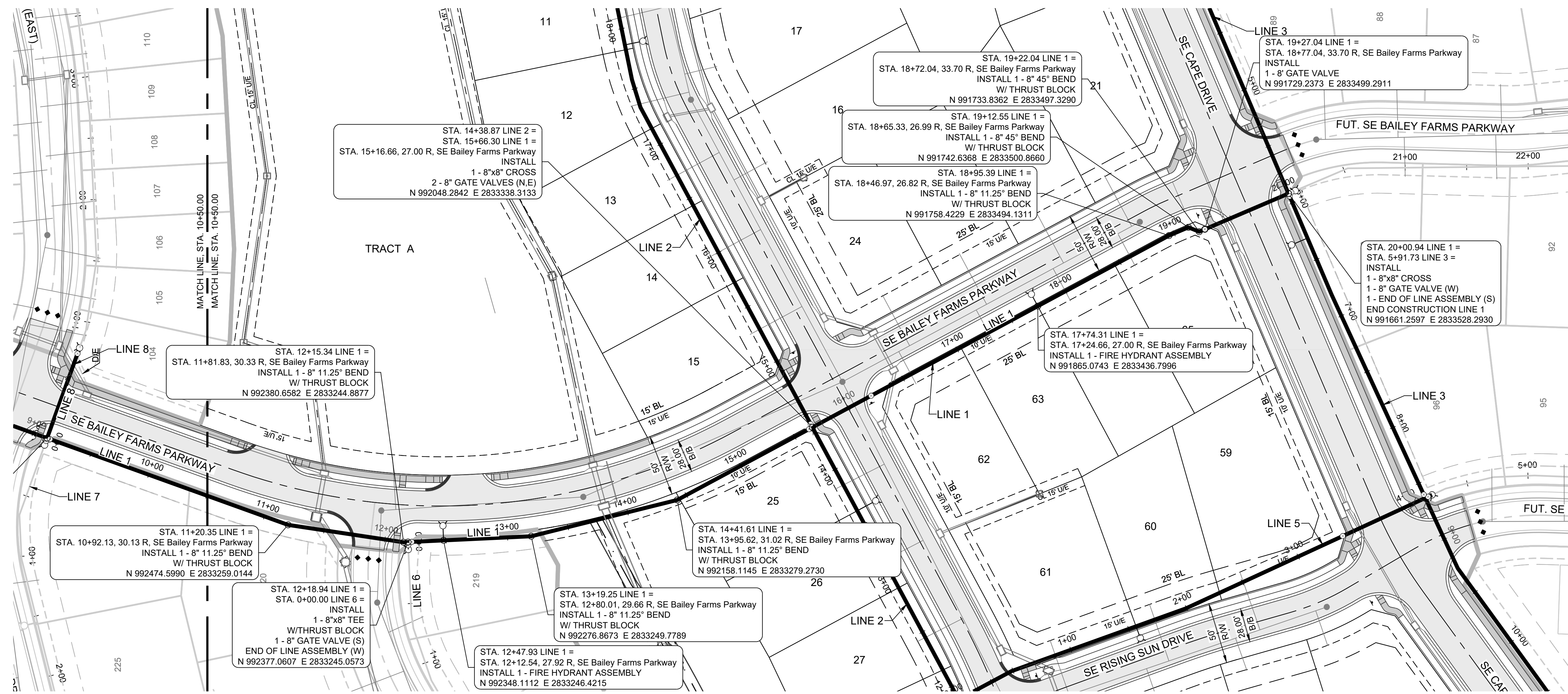

PROJECT BENCHMARK:
 Brass Disk at the Northeast Corner of the Northeast One-Quarter of Section 16, Township 47 N, Range 31 W, Intersection of SE. Bailey Road and SE. Ranson Road.
 ELEV. = 939.19

NOTES:

- ALL CONSTRUCTION TO FOLLOW THE CITY OF LEE'S SUMMIT DESIGN AND CONSTRUCTION MANUAL AS ADOPTED BY ORDINANCE 5813.
- THE CONTRACTOR IS RESPONSIBLE FOR VERIFYING ALL EXISTING UTILITY LOCATIONS PRIOR TO EXCAVATION.
- FOR ALL WATER LINES THE MAXIMUM DEPTH OF COVER IS SEVEN (7) FEET, EXCEPT WERE NOTED.

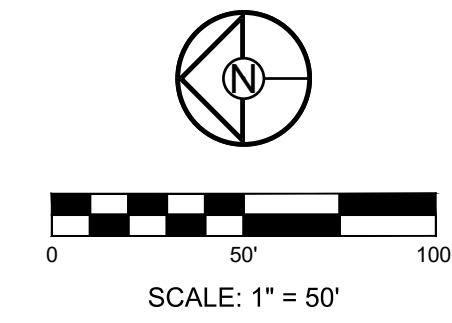

SCHLAGEL
 ENGINEERS PLANNERS SURVEYORS LANDSCAPE ARCHITECTS
 14920 West 107th Street • Lenexa, Kansas 66215
 (913) 492-5158 • Fax: (913) 492-8400
 WWW.SCHLAGELASSOCIATES.COM
 Missouri State Certificate of Authority
 #E200203690F #LAC001005237 #LS200208695F

PREPARED BY:

 JAMES L. LONG
 NUMBER PE-301403495
 PROFESSIONAL ENGINEER
 6/30/2022
 SCHLAGEL & ASSOCIATES, P.A.

MANOR AT BAILEY FARMS, FIRST PLAT
 WATER LINE PLANS
 SE BAILEY ROAD AND SE RANSON ROAD
 LEE'S SUMMIT, MISSOURI

LINE 1

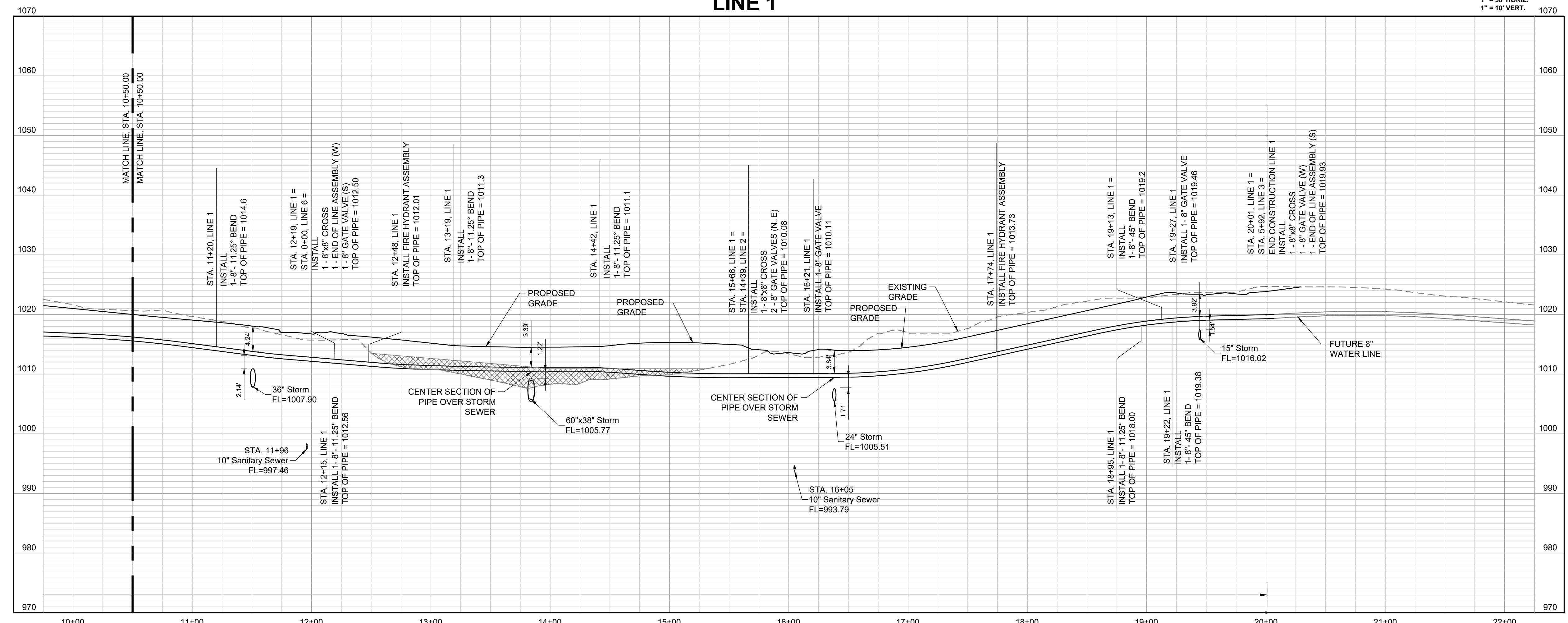

COMPACTED FILL TO BE PLACED A MINIMUM OF 18" ABOVE TOP OF PIPE PRIOR TO PIPE EXCAVATION

REVISION DATE	DESCRIPTION
01/24/2022	Per City Comments dated 11/19/2022
04/20/2022	Per City Comments dated 02/15/2022
05/31/2022	Per City Comments dated 05/24/2022
06/30/2022	Per City Comments dated 05/31/2022

DRAWN BY:	MBH
CHECKED BY:	JLL
DATE PREPARED:	11/05/2021
PROJ. NUMBER:	21-130

WATER LINE 1 PLAN & PROFILE CONT'D	
SHEET	
6	

I:\PROJECTS\2021\21-130\3.0 Design\3.0 DWG Plans\8.0 WATER P&P.dwg, 6/30/2022 6:37:49 AM, 11

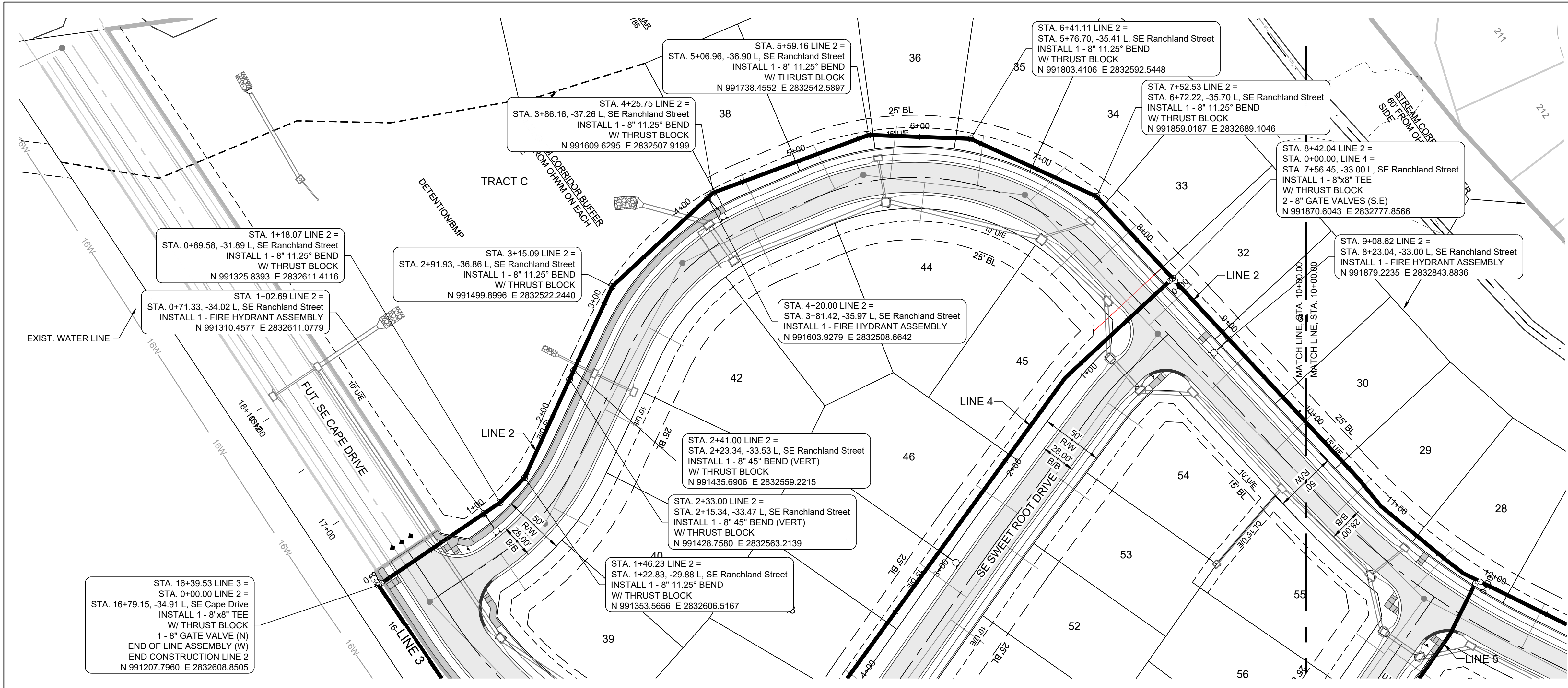

PROJECT BENCHMARK:
 Brass Disk at the Northeast Corner of the Northeast One-Quarter of Section 16, Township 47 N, Range 31 W, Intersection of SE, Bailey Road and SE, Ranson Road.
 ELEV. = 939.19

NOTES:

- ALL CONSTRUCTION TO FOLLOW THE CITY OF LEE'S SUMMIT DESIGN AND CONSTRUCTION MANUAL AS ADOPTED BY ORDINANCE 5813.
- THE CONTRACTOR IS RESPONSIBLE FOR VERIFYING ALL EXISTING UTILITY LOCATIONS PRIOR TO EXCAVATION.
- FOR ALL WATER LINES THE MAXIMUM DEPTH OF COVER IS SEVEN (7) FEET, EXCEPT WHERE NOTED.

SCHLAGEL
 ENGINEERS PLANNERS SURVEYORS LANDSCAPE ARCHITECTS
 14920 West 107th Street • Lenexa, Kansas 66215
 (913) 492-5158 • Fax: (913) 492-8400
 WWW.SCHLAGELASSOCIATES.COM
 Missouri State Certificates of Authority
 #E200200360F #LAC200100523F #S200200869F

PREPARED BY:

 JAMES L. LONG
 NUMBER PE-310401945
 6/30/2022
 SCHLAGEL & ASSOCIATES, P.A.

MANOR AT BAILEY FARMS, FIRST PLAT
 WATER LINE PLANS
 SE BAILEY ROAD AND SE RANSON ROAD
 LEE'S SUMMIT, MISSOURI

LINE 2

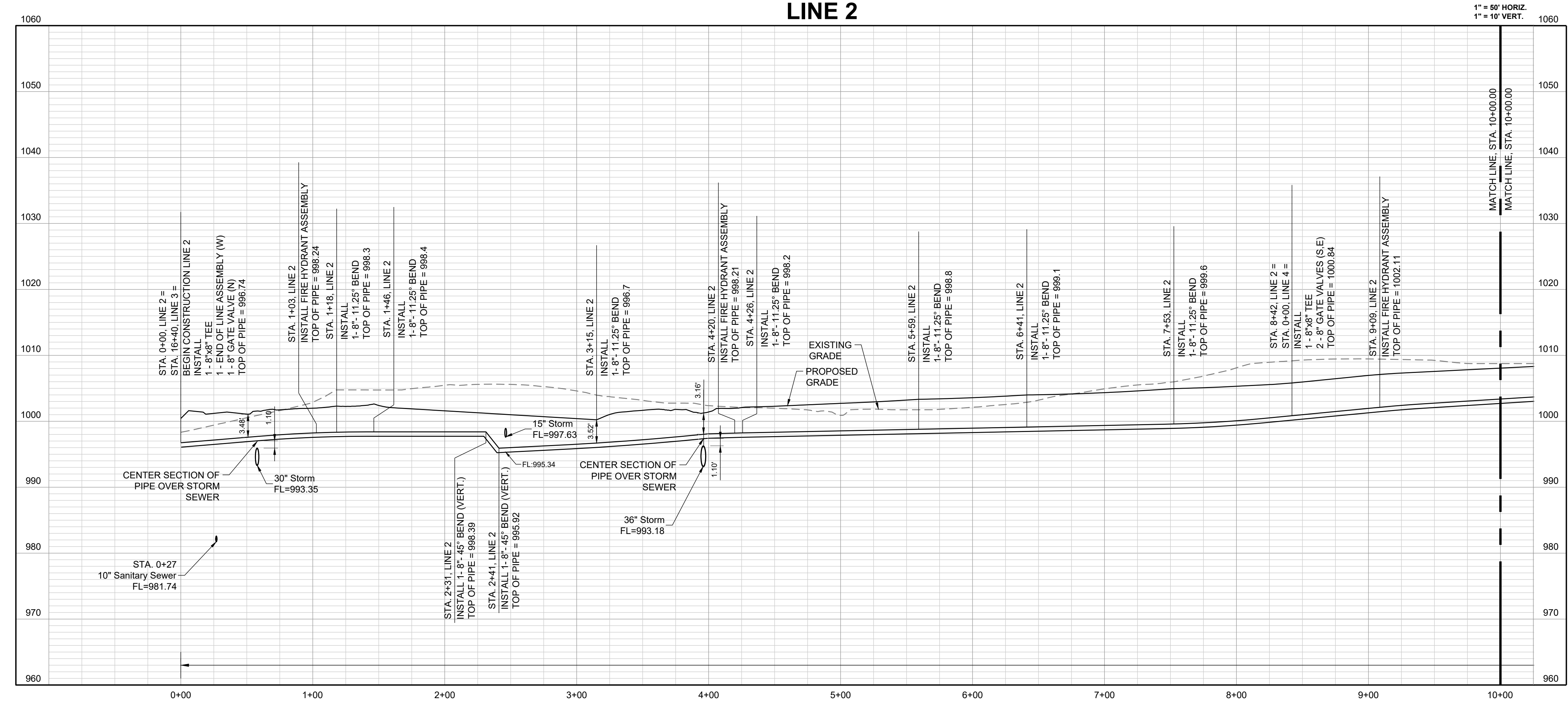

REVISION DATE	DESCRIPTION
01/24/2022	Per City Comments dated 11/19/2022
04/20/2022	Per City Comments dated 02/15/2022
05/31/2022	Per City Comments dated 05/24/2022
6/30/2022	Per City Comments dated 05/31/2022

DRAWN BY:	MBH
CHECKED BY:	JLL
DATE PREPARED:	11/05/2021
PROJ. NUMBER:	21-130

WATER LINE 2
 PLAN & PROFILE

SHEET
7

I:\PROJECTS\2021\21-130\3.0 Design\3.0 DWG Plans\8.0 Water\21-130-WATER P&P.dwg, 6/30/2022 6:38:02 AM, 1:1

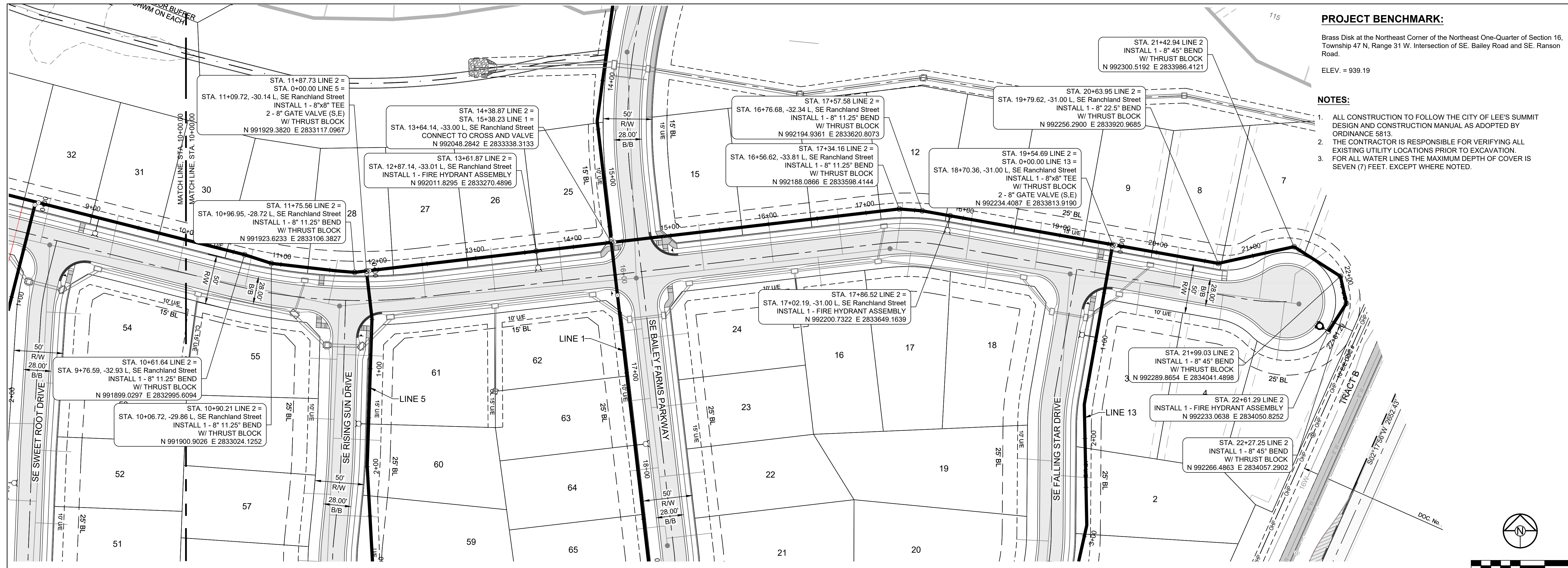

PROJECT BENCHMARK:
 Brass Disk at the Northeast Corner of the Northeast One-Quarter of Section 16,
 Township 47 N, Range 31 W, Intersection of SE. Bailey Road and SE. Ranson
 Road.
 ELEV. = 939.19

NOTES:

- ALL CONSTRUCTION TO FOLLOW THE CITY OF LEE'S SUMMIT DESIGN AND CONSTRUCTION MANUAL AS ADOPTED BY ORDINANCE 5813.
- THE CONTRACTOR IS RESPONSIBLE FOR VERIFYING ALL EXISTING UTILITY LOCATIONS PRIOR TO EXCAVATION.
- FOR ALL WATER LINES THE MAXIMUM DEPTH OF COVER IS SEVEN (7) FEET, EXCEPT WHERE NOTED.

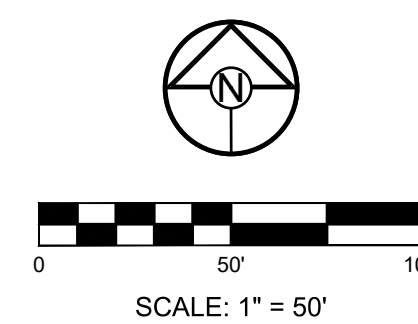

SCHLAGEL
 ENGINEERS PLANNERS SURVEYORS LANDSCAPE ARCHITECTS
 14920 West 107th Street • Lenexa, Kansas 66215
 (913) 492-5159 • Fax: (913) 492-8400
 WWW.SCHLAGELASSOCIATES.COM
 Missouri State Certificate of Authority
 #E20020036037 #LAC2001005237 #LS2002008659F

PREPARED BY:

 JAMES L. LONG
 NUMBER PE-30460495
 STATE OF MISSOURI
 PROFESSIONAL ENGINEER
 6/30/2022
 SCHLAGEL & ASSOCIATES, P.A.

MANOR AT BAILEY FARMS, FIRST PLAT
WATER LINE PLANS
SE BAILEY ROAD AND SE RANSON ROAD
LEE'S SUMMIT, MISSOURI

LINE 2

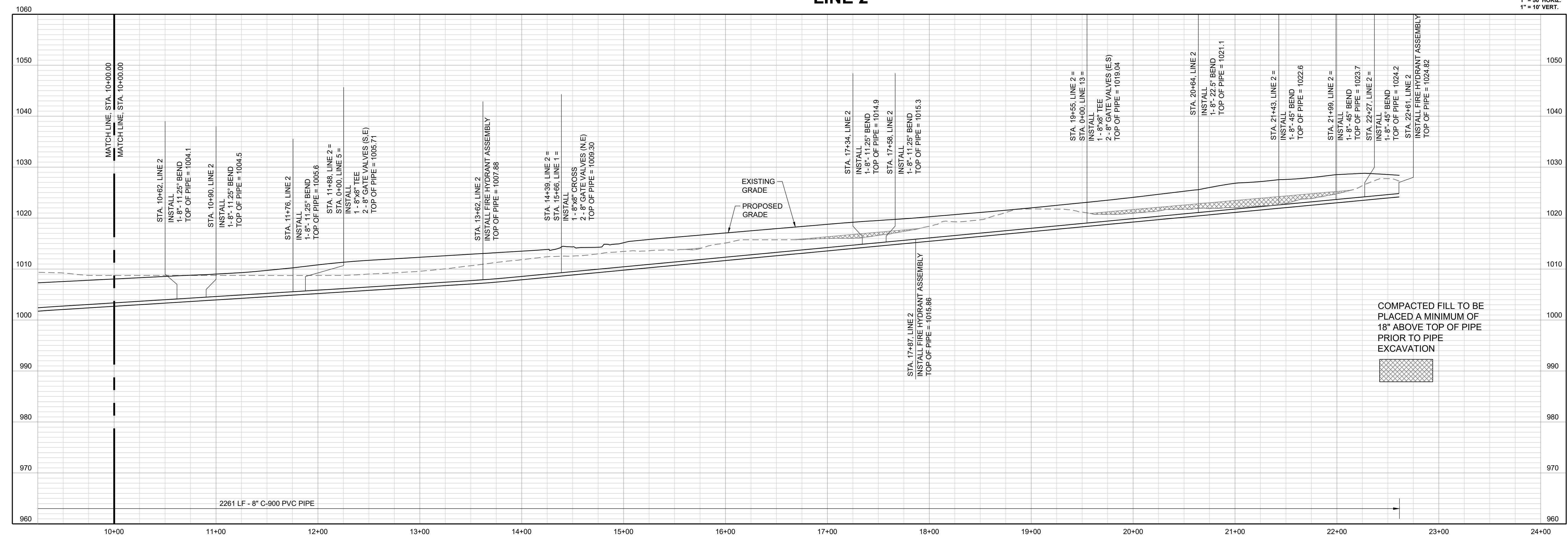

COMPACTED FILL TO BE
 PLACED A MINIMUM OF
 18" ABOVE TOP OF PIPE
 PRIOR TO PIPE
 EXCAVATION

REVISION DATE	DESCRIPTION
01/24/2022	Per City Comments dated 11/19/2022
04/20/2022	Per City Comments dated 02/15/2022
05/31/2022	Per City Comments dated 05/24/2022
6/30/2022	Per City Comments dated 05/31/2022

DRAWN BY:	MBH
CHECKED BY:	JLL
DATE PREPARED:	11/05/2021
PROJ. NUMBER:	21-130

WATER LINE 2
PLAN & PROFILE
CONT'D

I:\PROJECTS\2021\21-130\3.0 Design\3.0 DWG Plans\8.0 Water\21-130-WATER P&P.dwg, 6/30/2022 6:38:14 AM, 1:1

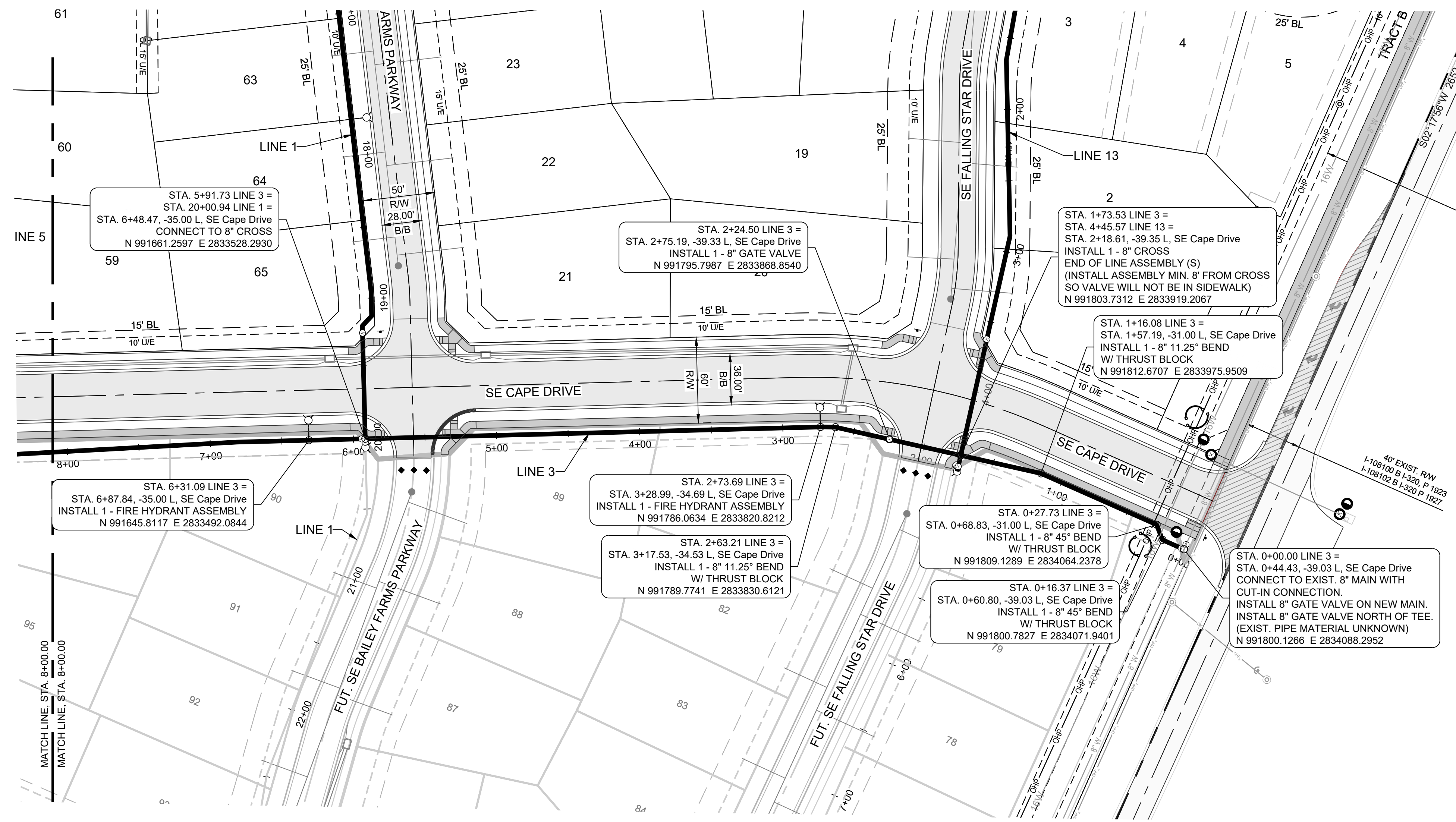

PROJECT BENCHMARK:
 Brass Disk at the Northeast Corner of the Northeast One-Quarter of Section 16,
 Township 47 N, Range 31 W, Intersection of SE. Bailey Road and SE. Ranson
 Road.
 ELEV. = 939.19

NOTES:

- ALL CONSTRUCTION TO FOLLOW THE CITY OF LEE'S SUMMIT DESIGN AND CONSTRUCTION MANUAL AS ADOPTED BY ORDINANCE 5813.
- THE CONTRACTOR IS RESPONSIBLE FOR VERIFYING ALL EXISTING UTILITY LOCATIONS PRIOR TO EXCAVATION.
- FOR ALL WATER LINES THE MAXIMUM DEPTH OF COVER IS SEVEN (7) FEET. UNLESS OTHERWISE NOTED.

SCHLAGEL
 ENGINEERS, PLANNERS, SURVEYORS, LANDSCAPE ARCHITECTS
 14920 West 107th Street • Lenexa, Kansas 66215
 (913) 492-5158 • Fax: (913) 492-8400
 WWW.SCHLAGELASSOCIATES.COM
 Missouri State Certificates of Authority
 #E200200360F #LAC201005237 #LS200200865F

PREPARED BY:

 JAMES L. LONG
 NUMBER PE-301401845
 PROFESSIONAL ENGINEER
 6/30/2022
 SCHLAGEL & ASSOCIATES, P.A.

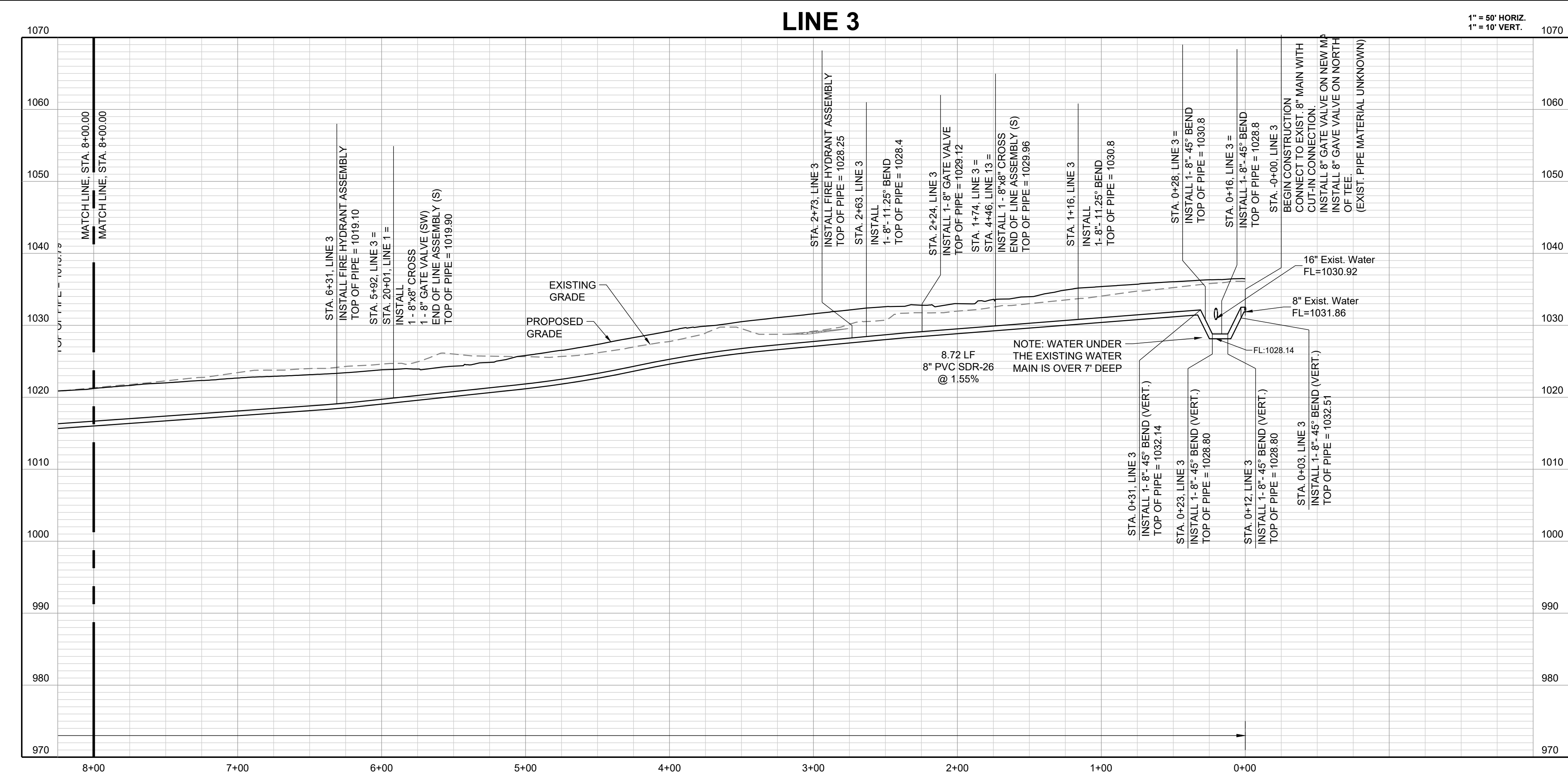

COMPACTED FILL TO BE PLACED A MINIMUM OF 18" ABOVE TOP OF PIPE PRIOR TO PIPE EXCAVATION

MANOR AT BAILEY FARMS, FIRST PLAT
 WATER LINE PLANS
 SE BAILEY ROAD AND SE RANSON ROAD
 LEE'S SUMMIT, MISSOURI

REVISION DATE	DESCRIPTION
01/24/2022	Per City Comments dated 11/19/2022
04/20/2022	Per City Comments dated 02/15/2022
05/31/2022	Per City Comments dated 05/24/2022
6/30/2022	Per City Comments dated 05/31/2022

DRAWN BY:	MBH
CHECKED BY:	JLL
DATE PREPARED:	11/05/2021
PROJ. NUMBER:	21-130

WATER LINE 3
 PLAN & PROFILE

SHEET
9

I:\PROJECTS\2021\21-130\3.0 Design\3.0 DWG Plans\8.0 WATER P&P.dwg, 6/30/2022 6:38:27 AM, 11

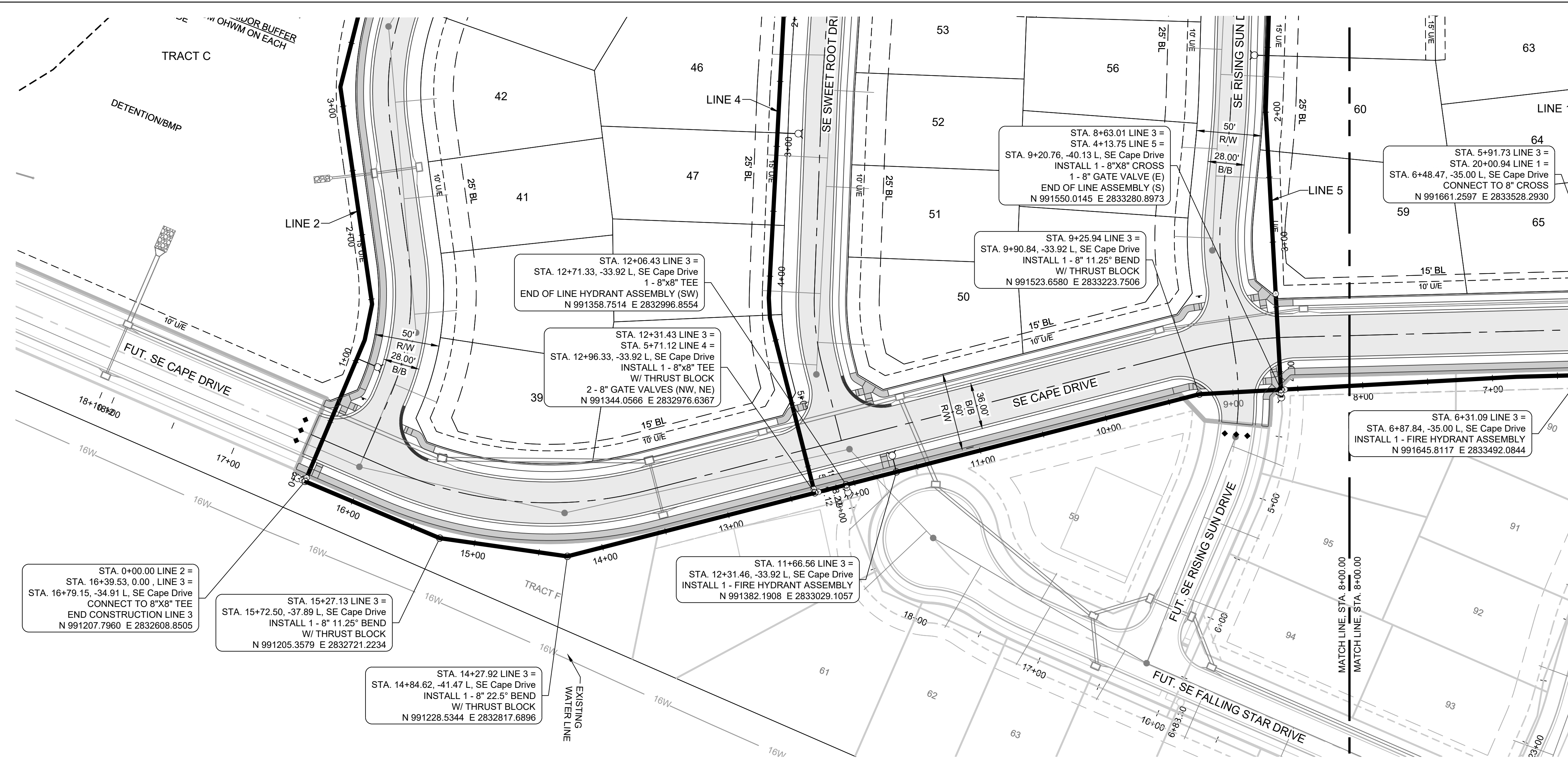

PROJECT BENCHMARK:
 Brass Disk at the Northeast Corner of the Northeast One-Quarter of Section 16,
 Township 47 N, Range 31 W, Intersection of SE. Bailey Road and SE. Ranson
 Road.
 ELEV. = 939.19

NOTES:

- ALL CONSTRUCTION TO FOLLOW THE CITY OF LEE'S SUMMIT DESIGN AND CONSTRUCTION MANUAL AS ADOPTED BY ORDINANCE 5813.
- THE CONTRACTOR IS RESPONSIBLE FOR VERIFYING ALL EXISTING UTILITY LOCATIONS PRIOR TO EXCAVATION.
- FOR ALL WATER LINES THE MAXIMUM DEPTH OF COVER IS SEVEN (7) FEET, UNLESS OTHERWISE NOTED.

SCHLAGEL
 ENGINEERS PLANNERS SURVEYORS LANDSCAPE ARCHITECTS
 14920 West 107th Street • Lenexa, Kansas 66215
 (913) 492-5158 • Fax: (913) 492-8400
 WWW.SCHLAGELASSOCIATES.COM
 Missouri State Certificates of Authority
 #E2002003600-F #LAC2001005237 #LS200200869-F

PREPARED BY:

 JAMES L. LONG
 NUMBER PE-301401895
 PROFESSIONAL ENGINEER
 6/30/2022
 SCHLAGEL & ASSOCIATES, P.A.

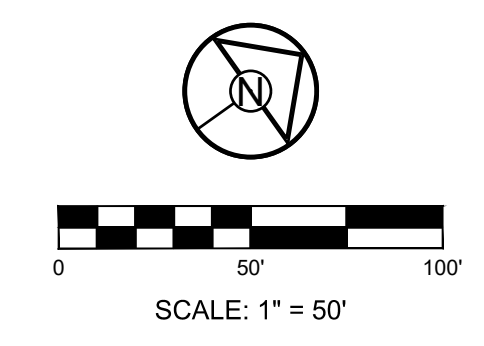

LINE 3

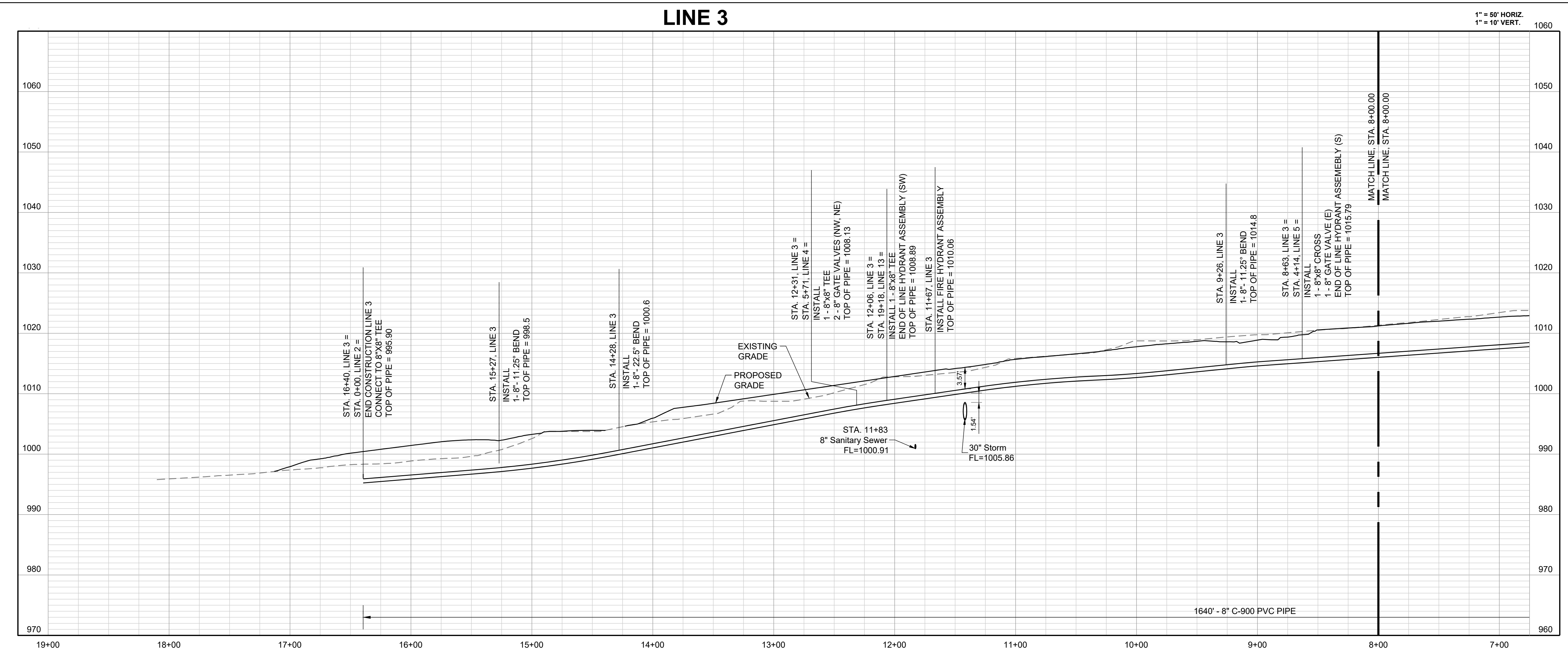

COMPACTED FILL TO BE PLACED A MINIMUM OF 18" ABOVE TOP OF PIPE PRIOR TO PIPE EXCAVATION

MANOR AT BAILEY FARMS, FIRST PLAT
WATER LINE PLANS
SE BAILEY ROAD AND SE RANSON ROAD
LEE'S SUMMIT, MISSOURI

REVISION DATE	DESCRIPTION
01/24/2022	Per City Comments dated 11/19/2022
04/20/2022	Per City Comments dated 02/15/2022
05/31/2022	Per City Comments dated 05/24/2022
06/30/2022	Per City Comments dated 05/31/2022

DRAWN BY:	DATE PREPARED:
MBH	11/05/2021

CHECKED BY:	PROJ. NUMBER:
JLL	21-130

WATER LINE 3
PLAN & PROFILE
CONT'D

I:\PROJECTS\2021\21-130\3.0 Design\3.0 DWG Plans\3.0 WATER P&P.dwg, 6/30/2022 6:38:39 AM, 11

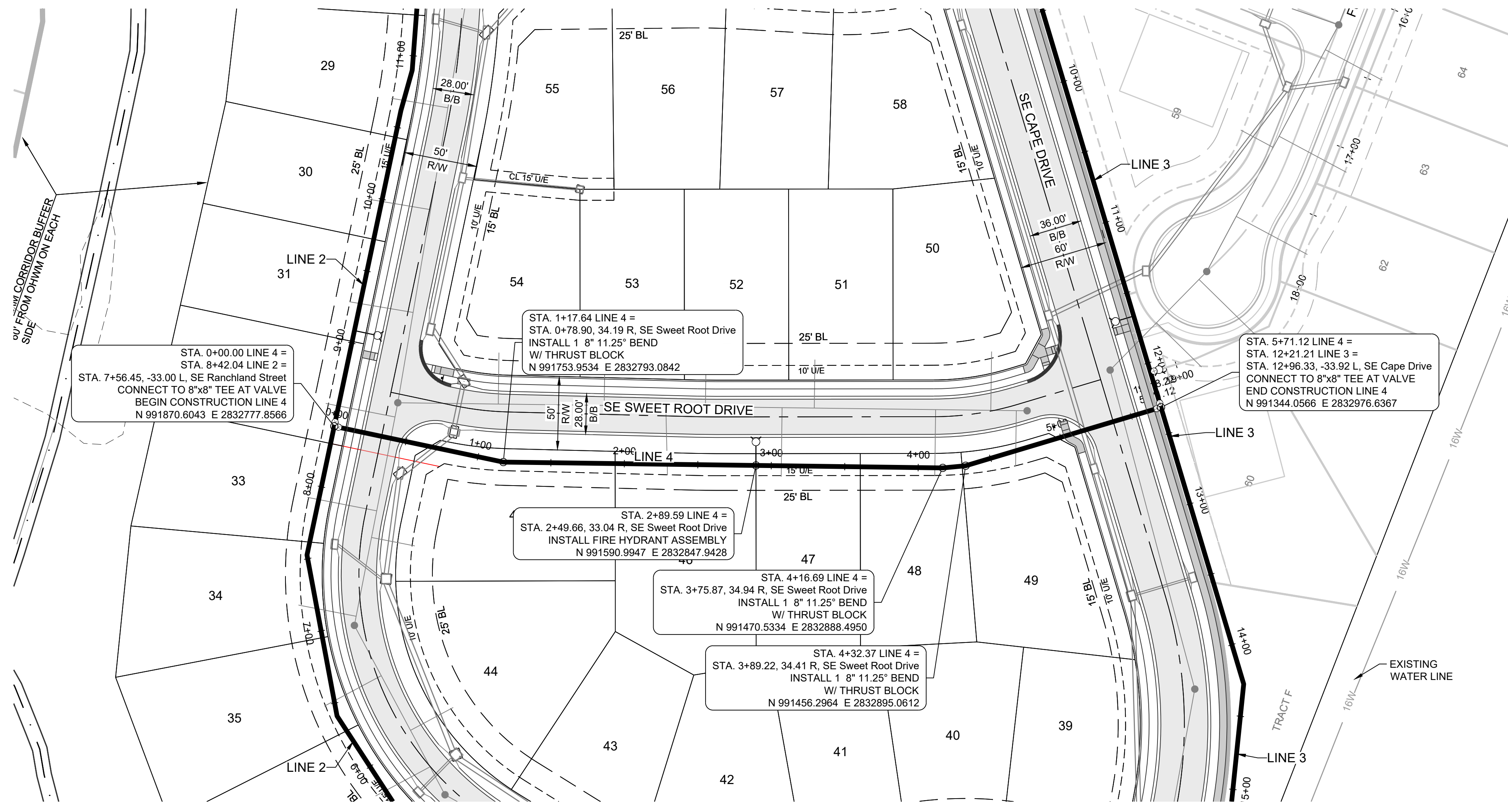

PROJECT BENCHMARK:
 Brass Disk at the Northeast Corner of the Northeast One-Quarter of Section 16, Township 47 N, Range 31 W, Intersection of SE. Bailey Road and SE. Ranson Road.
 ELEV. = 939.19

NOTES:

- ALL CONSTRUCTION TO FOLLOW THE CITY OF LEE'S SUMMIT DESIGN AND CONSTRUCTION MANUAL AS ADOPTED BY ORDINANCE 5813.
- THE CONTRACTOR IS RESPONSIBLE FOR VERIFYING ALL EXISTING UTILITY LOCATIONS PRIOR TO EXCAVATION.
- FOR ALL WATER LINES THE MAXIMUM DEPTH OF COVER IS SEVEN (7) FEET, UNLESS OTHERWISE NOTED.



SCHLAGEL
 ENGINEERS, PLANNERS, SURVEYORS, LANDSCAPE ARCHITECTS
 14920 West 107th Street • Lenexa, Kansas 66215
 (913) 492-5158 • Fax: (913) 492-8400
 WWW.SCHLAGELASSOCIATES.COM
 Missouri State Certificates of Authority
 #E200200360P-F #LAC2001005237 #LS200200869F

PREPARED BY:

 JAMES L. LONG
 NUMBER PE-301491895
 PROFESSIONAL ENGINEER
 6/30/2022
 SCHLAGEL & ASSOCIATES, P.A.

MANOR AT BAILEY FARMS, FIRST PLAT
WATER LINE PLANS
SE BAILEY ROAD AND SE RANSON ROAD
LEE'S SUMMIT, MISSOURI

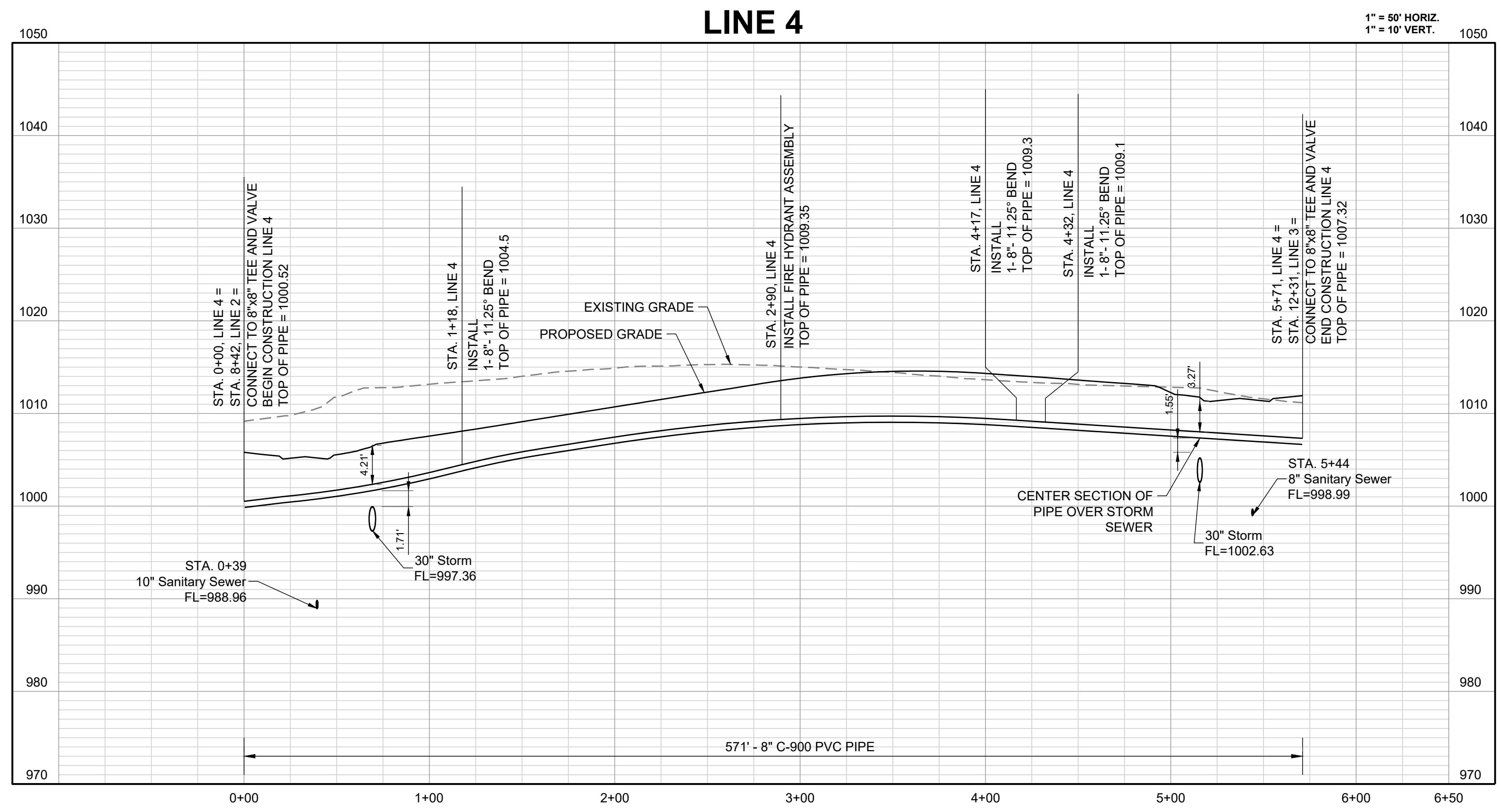

REVISION DATE	DESCRIPTION
01/24/2022	Per City Comments dated 11/19/2022
04/20/2022	Per City Comments dated 02/15/2022
05/31/2022	Per City Comments dated 05/24/2022
06/30/2022	Per City Comments dated 05/31/2022

DRAWN BY:	MBH
CHECKED BY:	JLL
DATE PREPARED:	11/05/2021
PROJ. NUMBER:	21-130

WATER LINE 4
PLAN & PROFILE

SHEET
11

I:\PROJECTS\2021\21-130\3.0 Design\3.0 DWG Plans\8.0 Water\21-130-WATER P&P.dwg, 6/30/2022 6:38:54 AM, 1:1

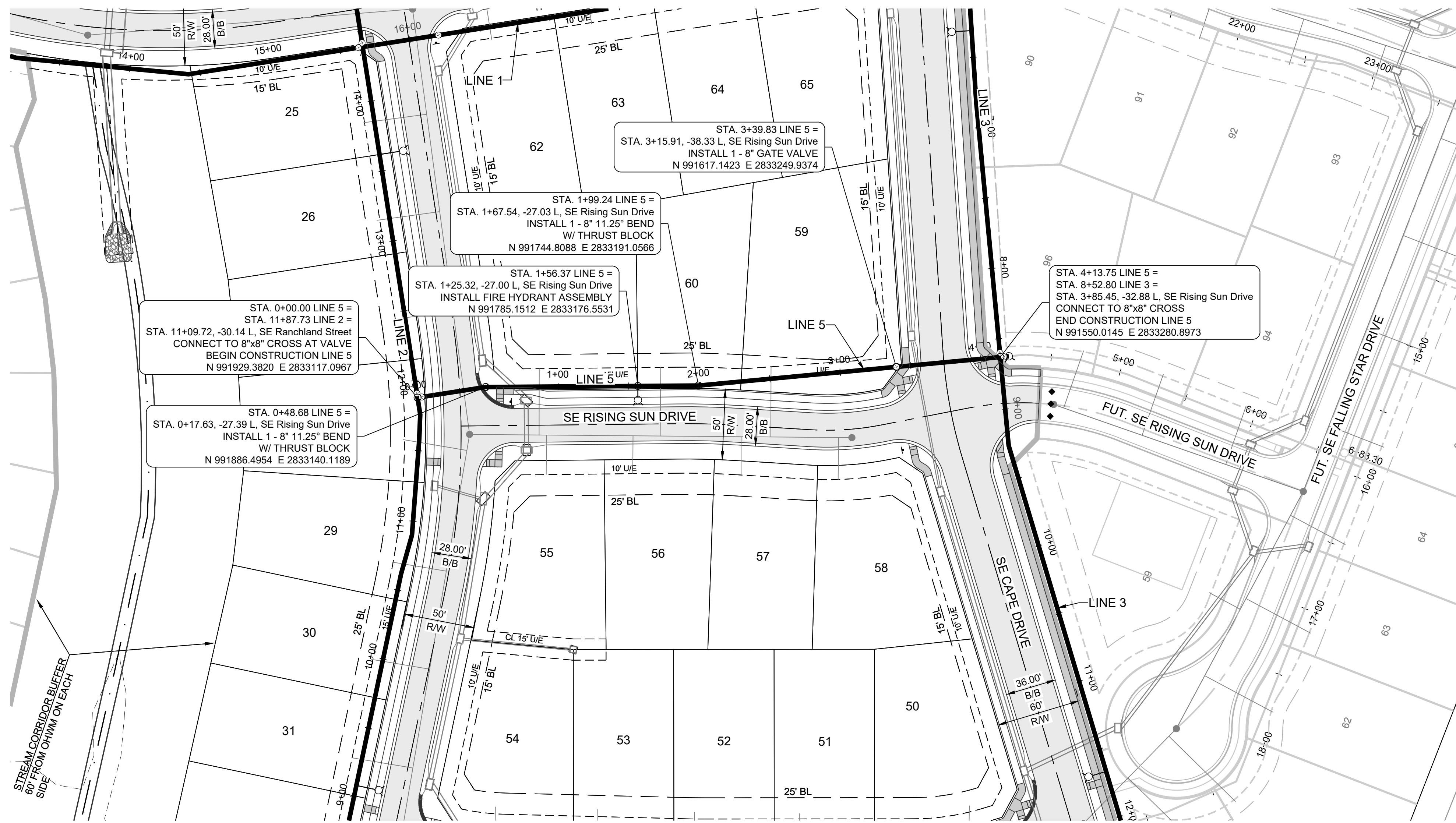

PROJECT BENCHMARK:

Brass Disk at the Northeast Corner of the Northeast One-Quarter of Section 16, Township 47 N, Range 31 W, Intersection of SE. Bailey Road and SE. Ranson Road.

ELEV. = 939.19

NOTES:

1. ALL CONSTRUCTION TO FOLLOW THE CITY OF LEE'S SUMMIT DESIGN AND CONSTRUCTION MANUAL AS ADOPTED BY ORDINANCE 5813.
2. THE CONTRACTOR IS RESPONSIBLE FOR VERIFYING ALL EXISTING UTILITY LOCATIONS PRIOR TO EXCAVATION.
3. FOR ALL WATER LINES THE MAXIMUM DEPTH OF COVER IS SEVEN (7) FEET.

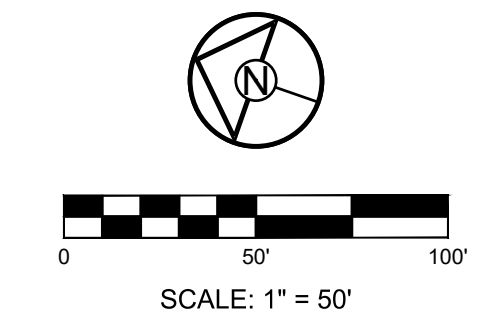

SCHLAGEL
ENGINEERS PLANNERS SURVEYORS LANDSCAPE ARCHITECTS
14920 West 107th Street • Lenexa, Kansas 66215
(913) 492-5158 • Fax: (913) 492-8400
WWW.SCHLAGELASSOCIATES.COM
Missouri State Certificates of Authority
#E200200360F #LAC2001005237 #LS200200869F

PREPARED BY:

6/30/2022

SCHLAGEL & ASSOCIATES, P.A.

MANOR AT BAILEY FARMS, FIRST PLAT
WATER LINE PLANS
SE BAILEY ROAD AND SE RANSON ROAD
LEE'S SUMMIT, MISSOURI

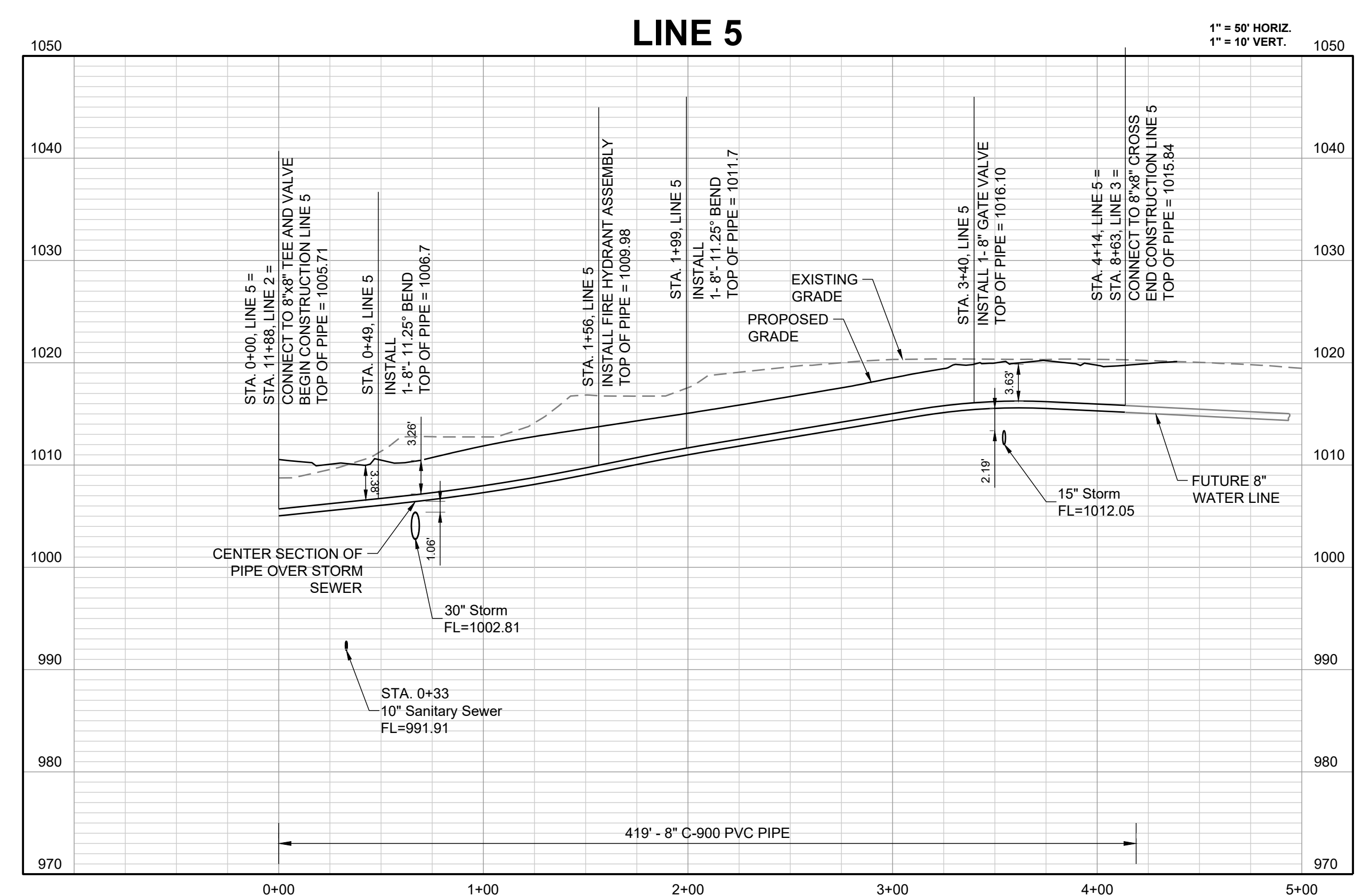

REVISION DATE	DESCRIPTION
01/24/2022	Per City Comments dated 11/19/2022
04/20/2022	Per City Comments dated 02/15/2022
05/31/2022	Per City Comments dated 05/24/2022
6/30/2022	Per City Comments dated 05/31/2022

DRAWN BY:	MBH
CHECKED BY:	JLL
DATE PREPARED:	11/05/2021
PROJ. NUMBER:	21-130

WATER LINE 5
PLAN & PROFILE

SHEET

I:\PROJECTS\2021\21-130\3.0 Design\3.0 DWG Plans\3.0 WATER P&P.dwg, 6/30/2022 6:39:02 AM, 11

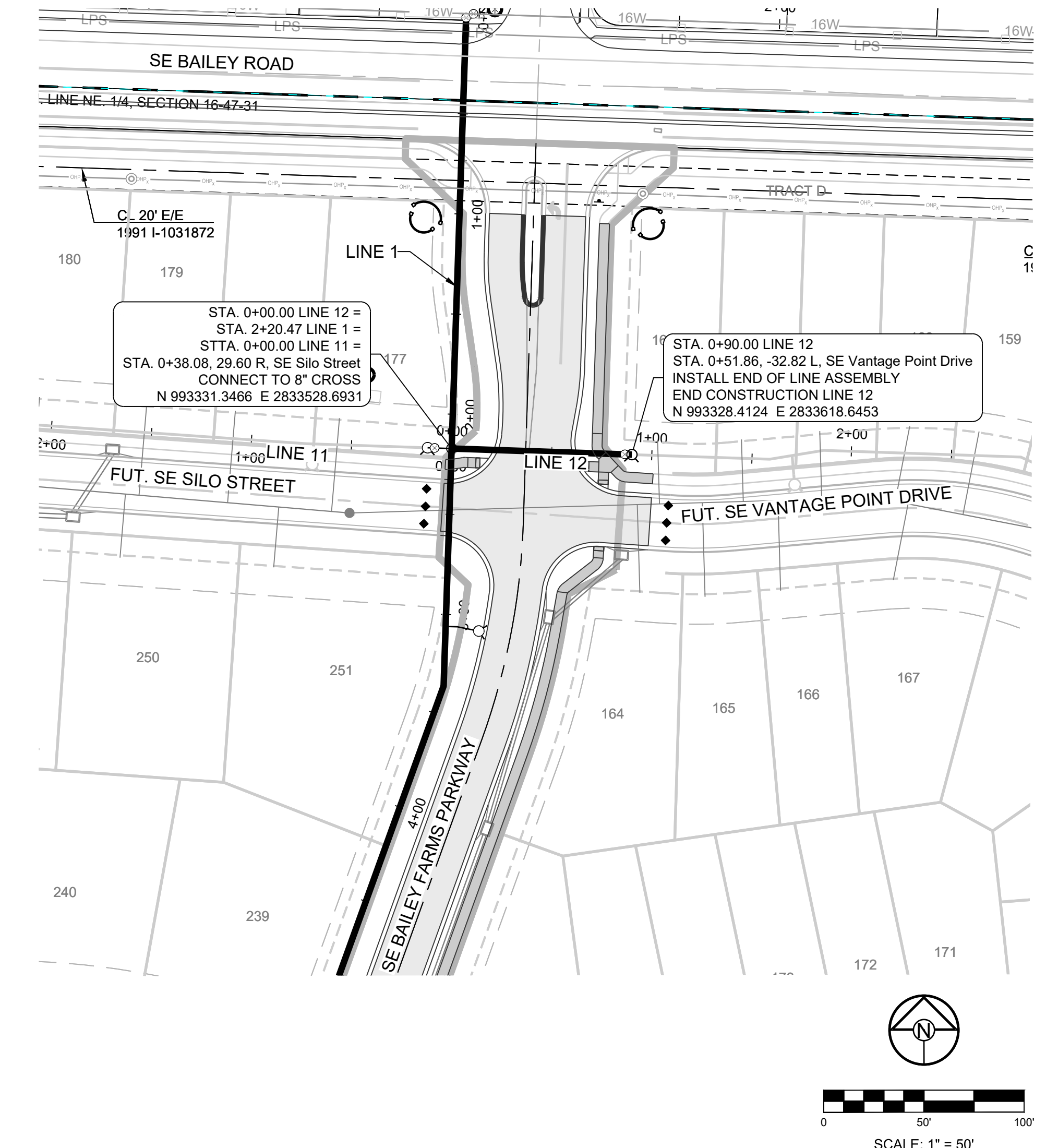
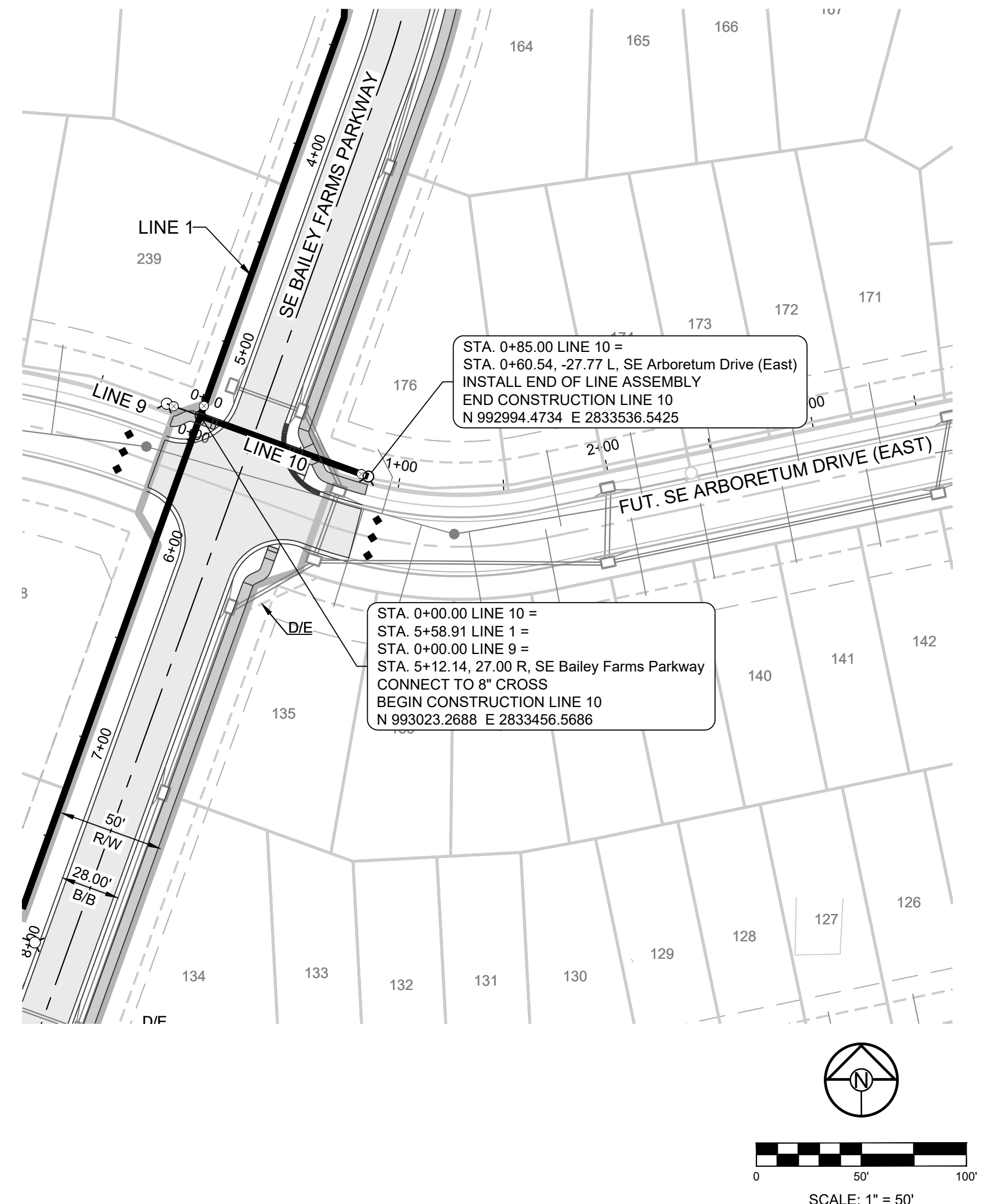
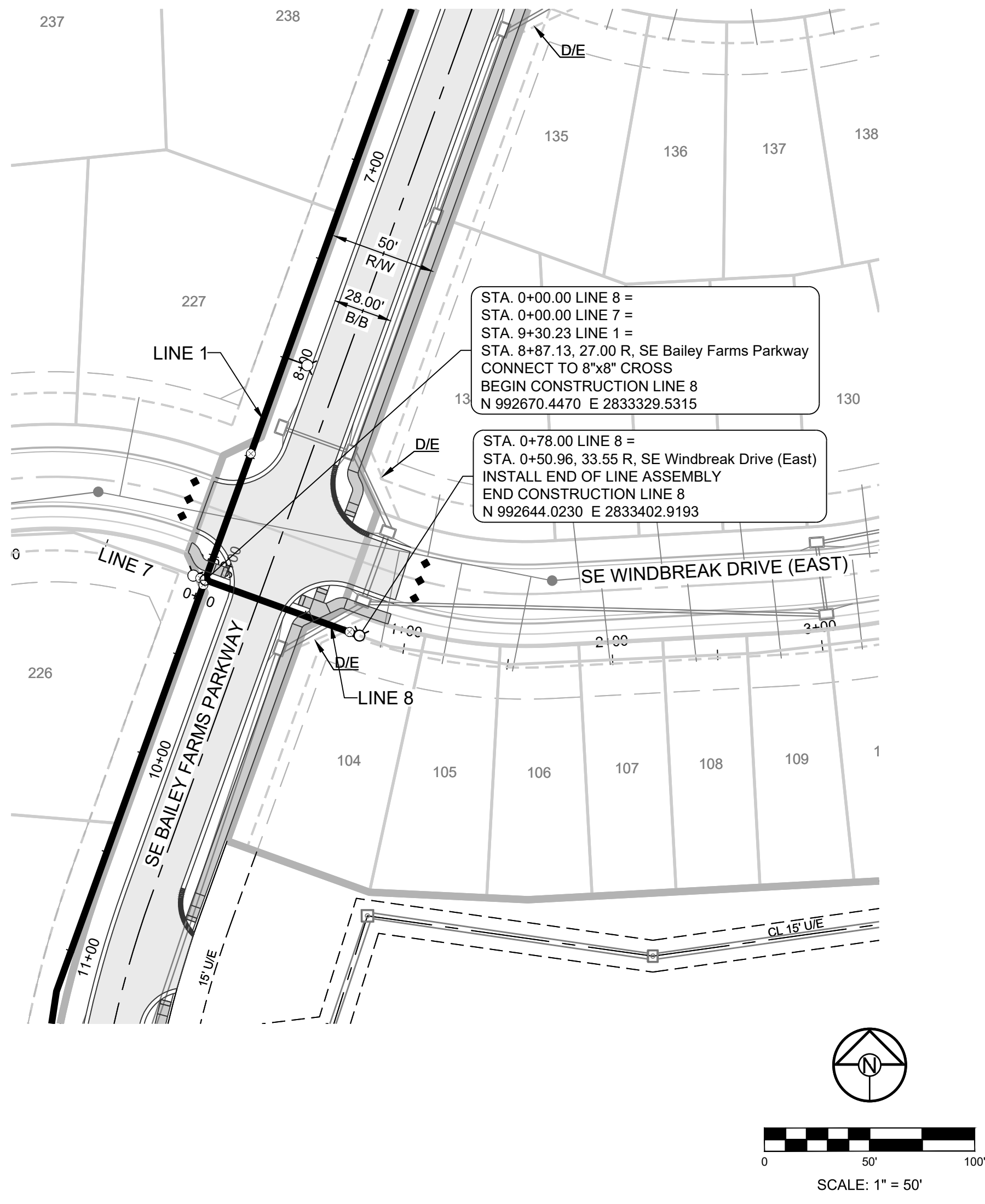

NOTES:

- ALL CONSTRUCTION TO FOLLOW THE CITY OF LEE'S SUMMIT DESIGN AND CONSTRUCTION MANUAL AS ADOPTED BY ORDINANCE 5813.
- THE CONTRACTOR IS RESPONSIBLE FOR VERIFYING ALL EXISTING UTILITY LOCATIONS PRIOR TO EXCAVATION.
- FOR ALL WATER LINES THE MAXIMUM DEPTH OF COVER IS SEVEN (7) FEET, UNLESS OTHERWISE NOTED.

PROJECT BENCHMARK:
Brass Disk at the Northeast Corner of the Northeast One-Quarter of Section 16, Township 47 N, Range 31 W, Intersection of SE. Bailey Road and SE. Ranson Road.
ELEV. = 939.19

SCHLAGEL
ENGINEERS PLANNERS SURVEYORS LANDSCAPE ARCHITECTS
14920 West 107th Street • Lenexa, Kansas 66215
(913) 492-5158 • Fax: (913) 492-8400
WWW.SCHLAGELASSOCIATES.COM
Missouri State Certificates of Authority
#E200200360P-F #LAC2001005237 #LS2002008959-F

PREPARED BY:
JAMES L. LONG
NUMBER PE-30149495
PROFESSIONAL ENGINEER
6/30/2022
SCHLAGEL & ASSOCIATES, P.A.

MANOR AT BAILEY FARMS, FIRST PLAT
WATER LINE PLANS
SE BAILEY ROAD AND SE RANSON ROAD
LEE'S SUMMIT, MISSOURI

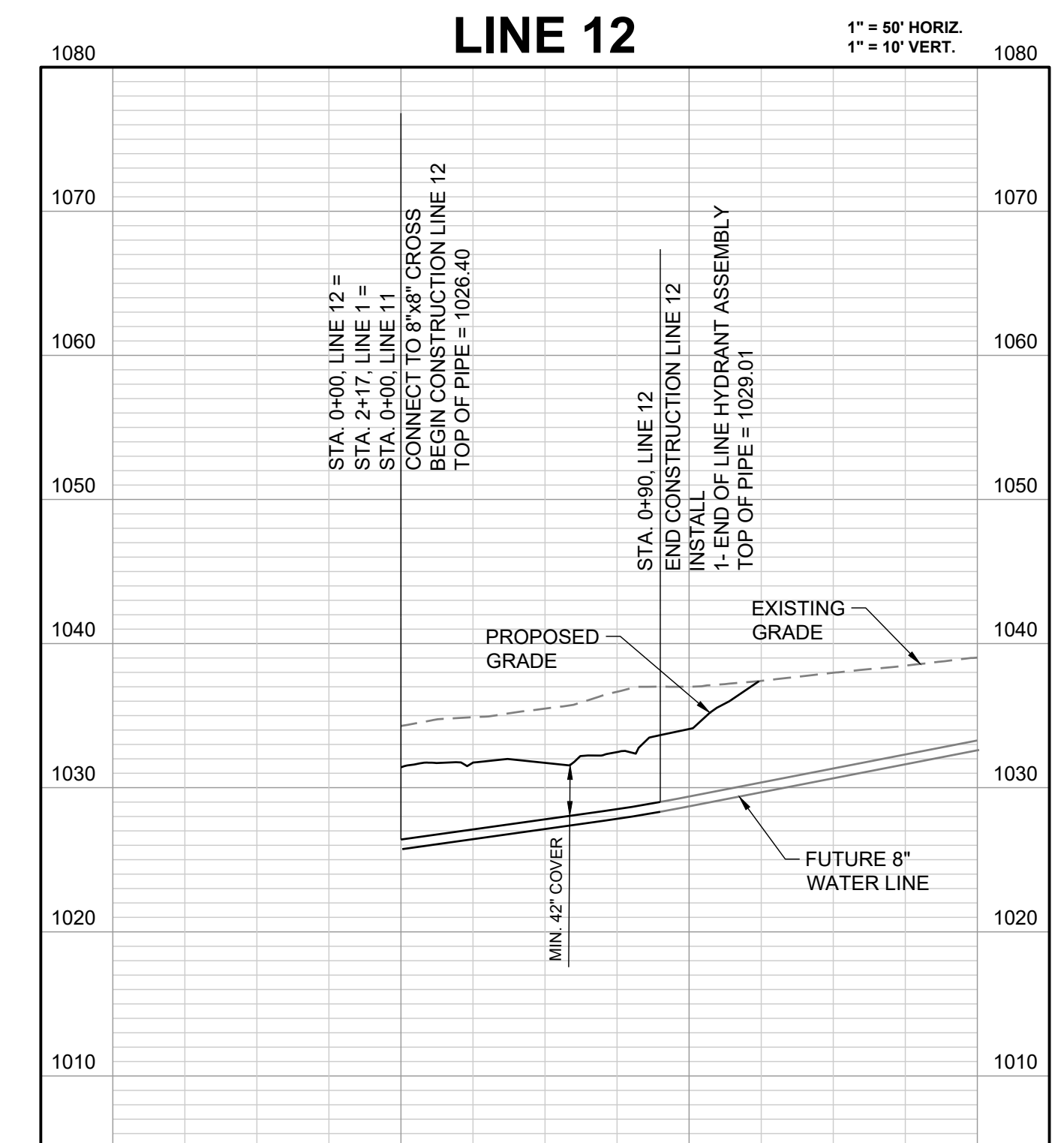
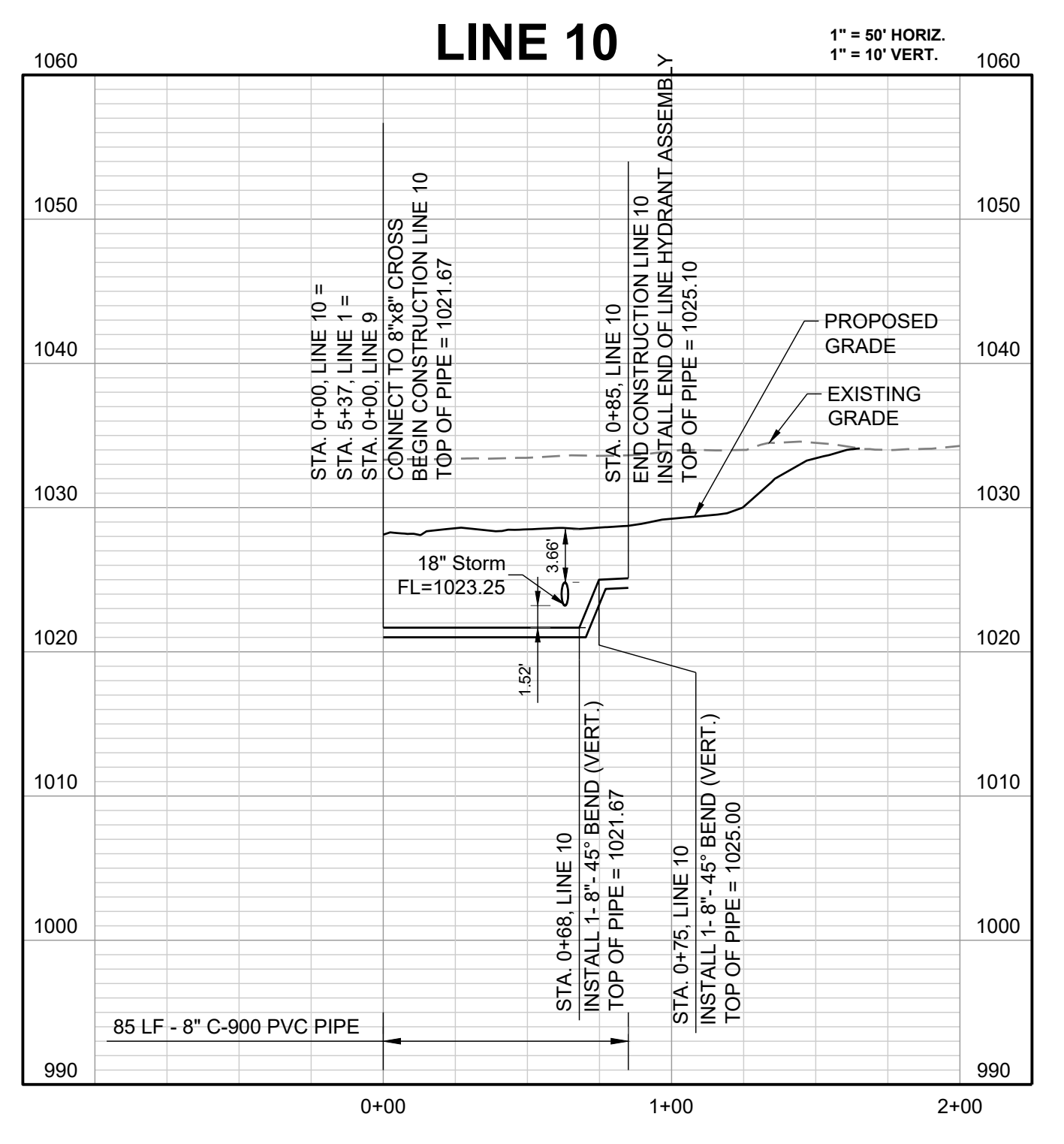
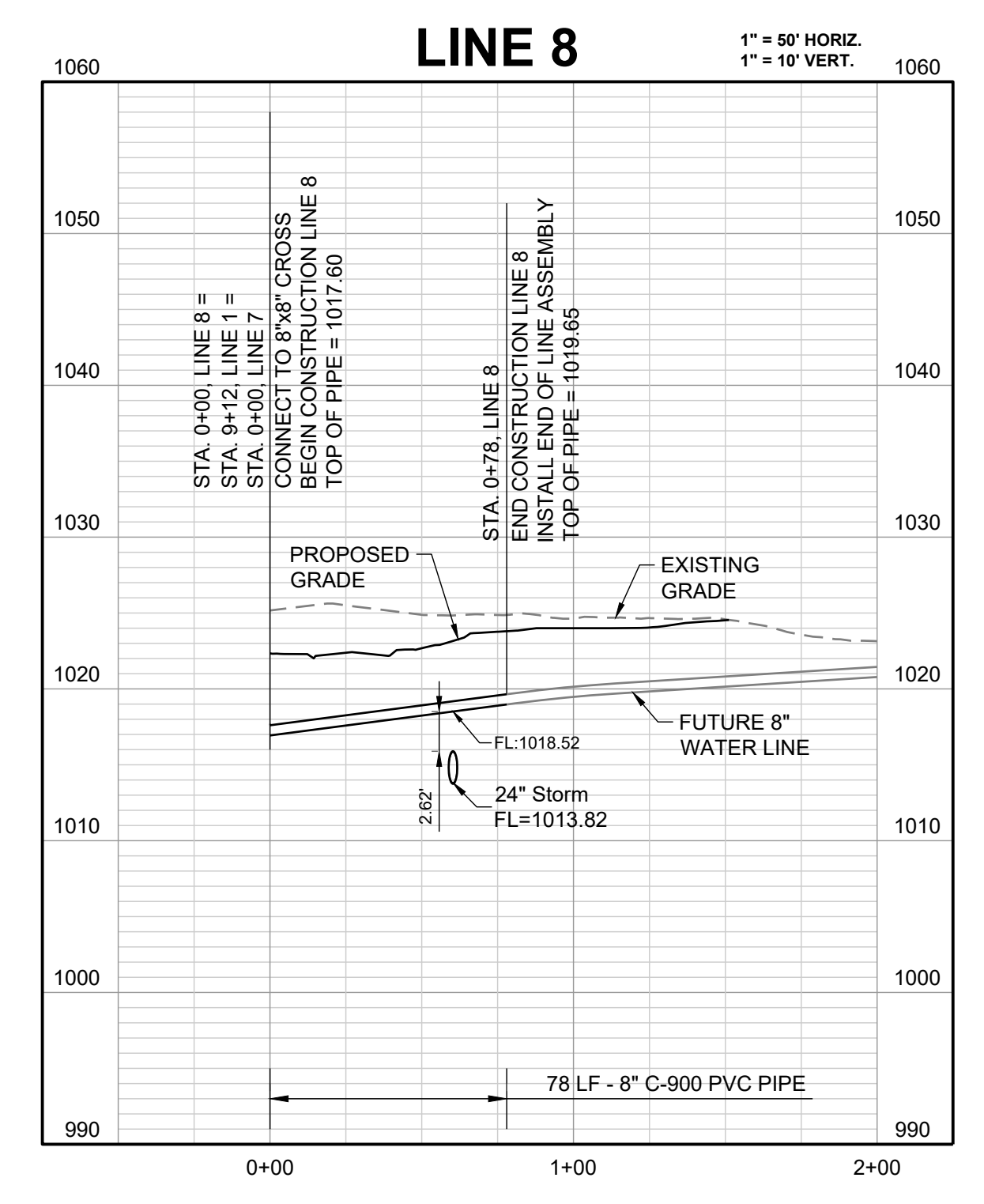

REVISION DATE	DESCRIPTION
01/24/2022	Per City Comments dated 11/19/2022
04/20/2022	Per City Comments dated 02/15/2022
05/31/2022	Per City Comments dated 05/24/2022
6/30/2022	Per City Comments dated 05/31/2022

DRAWN BY:	MBH
CHECKED BY:	JLL
DATE PREPARED:	11/05/2021
PROJ. NUMBER:	21-130

WATER LINE 8, 10, & 12 PLAN & PROFILE

SHEET
13

I:\PROJECTS\2021\21-130\3.0 Design\3.0 DWG Plans\8.0 Water\21-130-WATER P&P.dwg, 6/30/2022 6:39:20 AM, 1:1

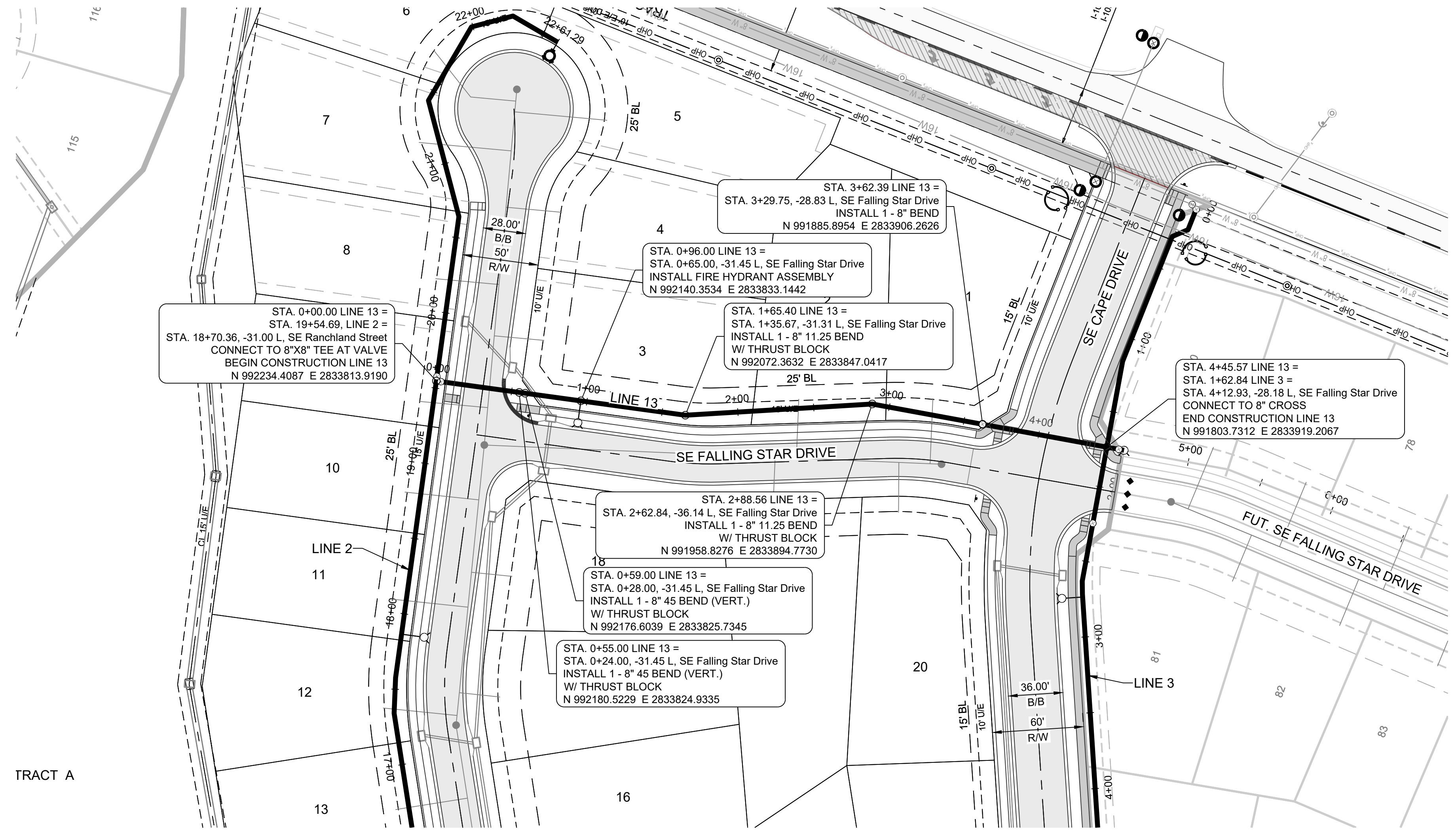

PROJECT BENCHMARK:
 Brass Disk at the Northeast Corner of the Northeast One-Quarter of Section 16,
 Township 47 N, Range 31 W, Intersection of SE. Bailey Road and SE. Ranson
 Road.
 ELEV. = 939.19

NOTES:

- ALL CONSTRUCTION TO FOLLOW THE CITY OF LEE'S SUMMIT DESIGN AND CONSTRUCTION MANUAL AS ADOPTED BY ORDINANCE 5813.
- THE CONTRACTOR IS RESPONSIBLE FOR VERIFYING ALL EXISTING UTILITY LOCATIONS PRIOR TO EXCAVATION.
- FOR ALL WATER LINES THE MAXIMUM DEPTH OF COVER IS SEVEN (7) FEET, UNLESS OTHERWISE NOTED

SCHLAGEL
 ENGINEERS, PLANNERS, SURVEYORS, LANDSCAPE ARCHITECTS
 14920 West 107th Street • Lenexa, Kansas 66215
 (913) 492-5158 • Fax: (913) 492-8400
 WWW.SCHLAGELASSOCIATES.COM
 Missouri State Certificates of Authority
 #E2002003606/F #LAC2001005237 #LS200200869/F

PREPARED BY:

 JAMES L. LONG
 NUMBER PE-30149495
 6/30/2022
 SCHLAGEL & ASSOCIATES, P.A.



MANOR AT BAILEY FARMS, FIRST PLAT
 WATER LINE PLANS
 SE BAILEY ROAD AND SE RANSON ROAD
 LEE'S SUMMIT, MISSOURI

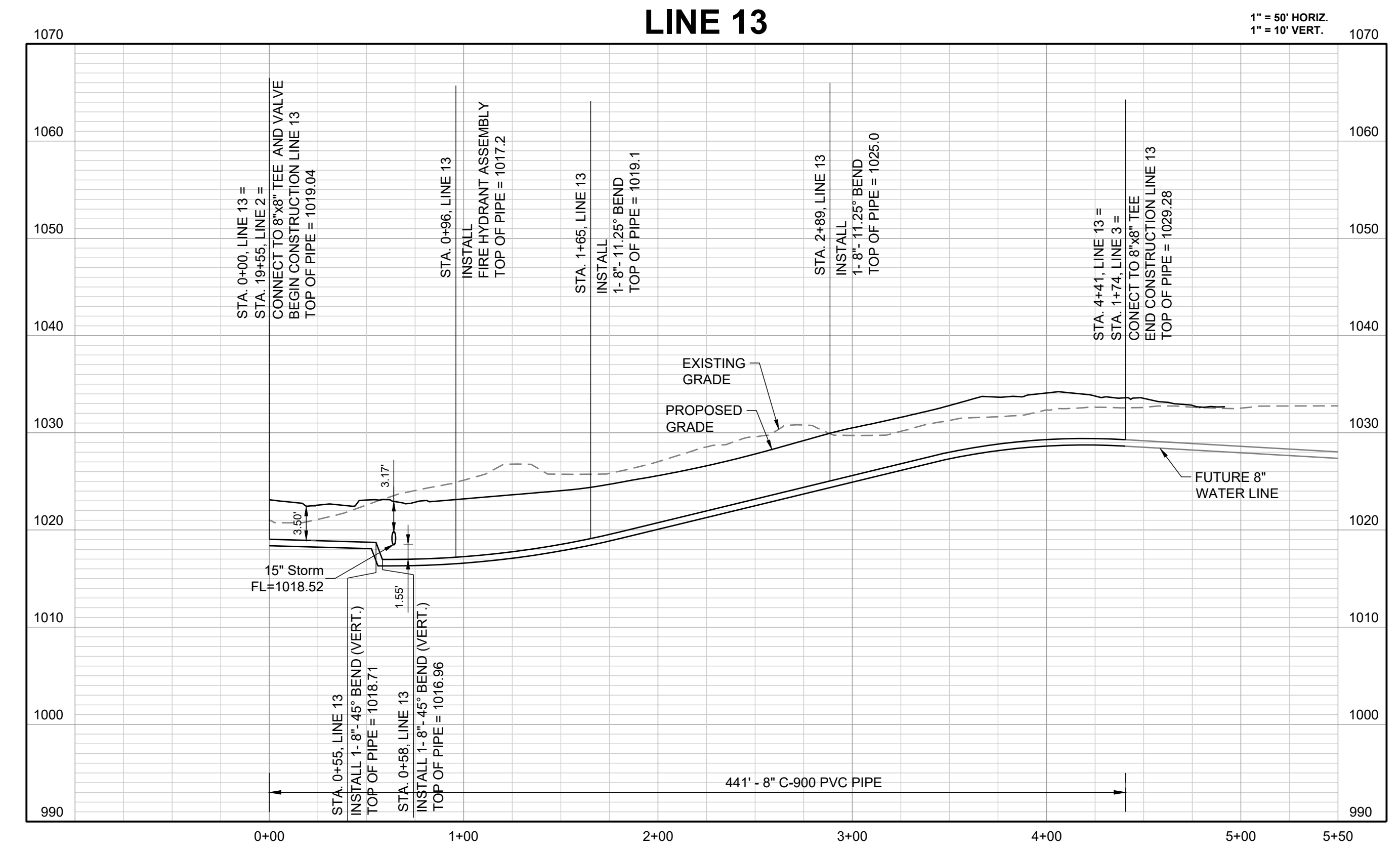

REVISION DATE	DESCRIPTION
01/24/2022	Per City Comments dated 11/19/2022
04/20/2022	Per City Comments dated 02/15/2022
05/31/2022	Per City Comments dated 05/24/2022
6/30/2022	Per City Comments dated 05/31/2022

DRAWN BY:	MBH
CHECKED BY:	JLL
DATE PREPARED:	11/05/2021
PROJ. NUMBER:	21-130

WATER LINE 13
 PLAN & PROFILE

SHEET
14

I:\PROJECTS\2021\21-130\3.0 Design\3.0 DWG Plans\8.0 Water\21-130-WATER P&P.dwg, 6/30/2022 6:39:34 AM, 11

REQUIRED CONCRETE BEARING AREA (SQUARE FEET - SF)					
NOM. DIA. (INCHES)	TEE, PLUG	BEND	BEND	BEND	11.25 BEND
6	4.7	6.7	4.0	4.0	4.0
8	8.4	11.9	6.4	4.0	4.0
10	13.1	18.5	10.0	5.1	4.0
12	18.8	26.7	14.4	5.4	4.0
14	25.7	36.3	19.6	10.0	5.0
16	33.5	47.4	25.6	13.1	6.6
18	42.4	REST. JT.	32.5	16.5	8.3
20	REST. JT.	REST. JT.	40.1	20.4	10.3
24	REST. JT.	REST. JT.	REST. JT.	29.4	14.8

- NOTES:
 1. ALL BENDS WITHOUT RESTRAINED JOINTS SHALL HAVE CONCRETE THRUST BLOCKS INSTALLED FOR RESTRAINT.
 2. MEGA LUGS MAY BE USED ONLY IN CONJUNCTION WITH CONCRETE THRUST BLOCKING.
 3. BEARING AREA MUST BE AGAINST UNDISTURBED SOIL.
 4. DO NOT COVER JOINTS OR BOLTS (WHERE APPLICABLE) WITH CONCRETE.

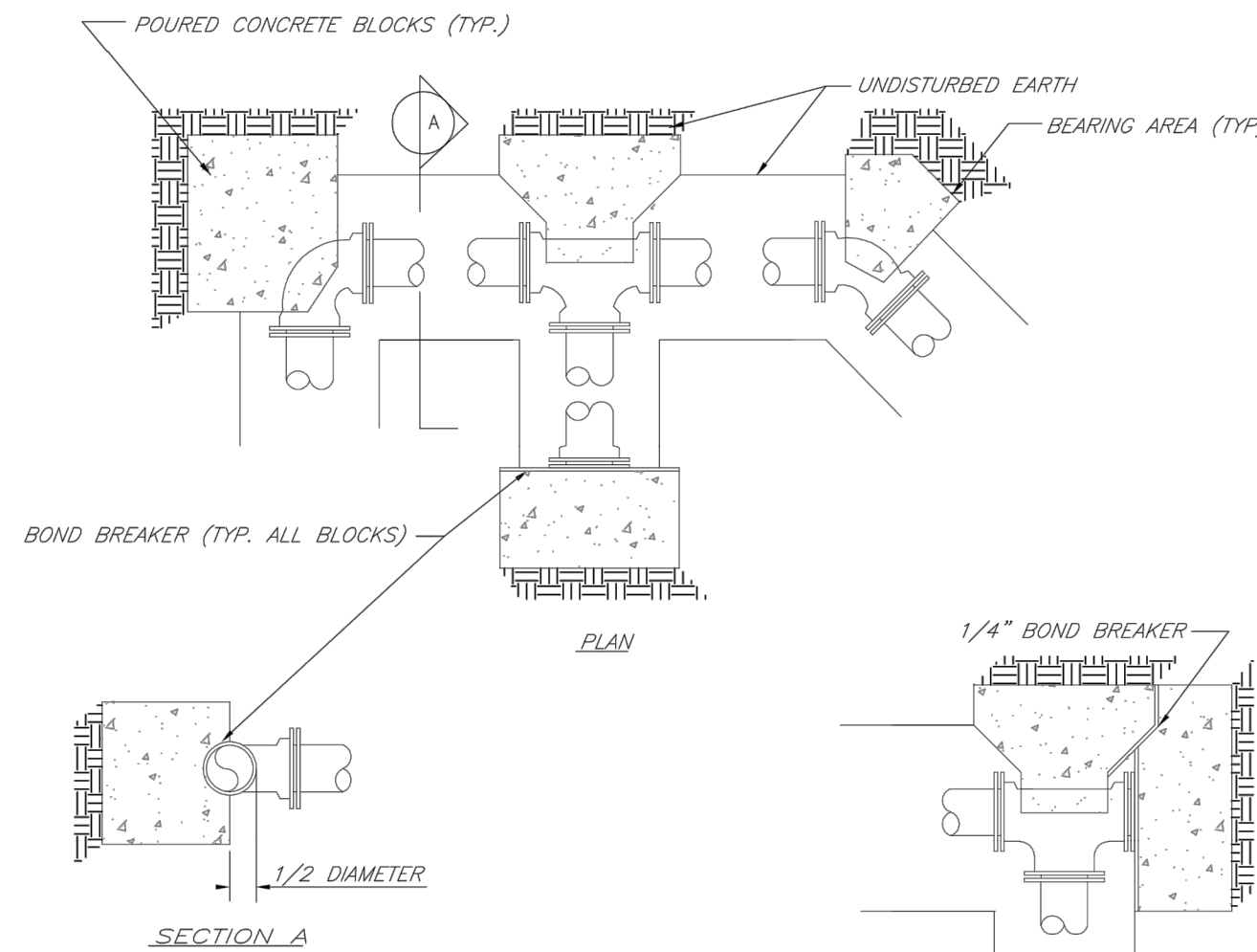

LEE'S SUMMIT MISSOURI
 PUBLIC WORKS ENGINEERING DIVISION | 1201 SE GREEN STREET | LEE'S SUMMIT, MO 64063
HORIZONTAL THRUST BLOCKS

Date: 02/13
 Drawn By: JN
 Checked By: DL
 File: W81-1
 Rev: 1/14

REQUIRED CONCRETE VOLUME (CUBIC FEET - CF)					
NOM. DIA. (INCHES)	TEE, PLUG	BEND	BEND	BEND	11.25 BEND
6	50.5	71.4	38.6	19.7	9.9
8	89.8	126.9	68.7	35.0	17.6
10	140.2	198.3	107.3	54.7	27.5
12	202.0	REST. JT.	154.6	78.9	39.6
14	REST. JT.	REST. JT.	210.4	107.3	53.9
16	REST. JT.	REST. JT.	REST. JT.	140.1	70.4
18	REST. JT.	REST. JT.	REST. JT.	177.3	89.1
20	REST. JT.	REST. JT.	REST. JT.	REST. JT.	110.0
24	REST. JT.	REST. JT.	REST. JT.	REST. JT.	158.4

- NOTES:
 1. ALL BENDS WITHOUT RESTRAINED JOINTS SHALL HAVE CONCRETE THRUST BLOCKS INSTALLED FOR RESTRAINT.
 2. MEGA LUGS MAY BE USED ONLY IN CONJUNCTION WITH CONCRETE THRUST BLOCKING.
 3. BEARING MUST BE AGAINST UNDISTURBED SOIL.
 4. DO NOT COVER JOINTS OR BOLTS (WHERE APPLICABLE) WITH CONCRETE.

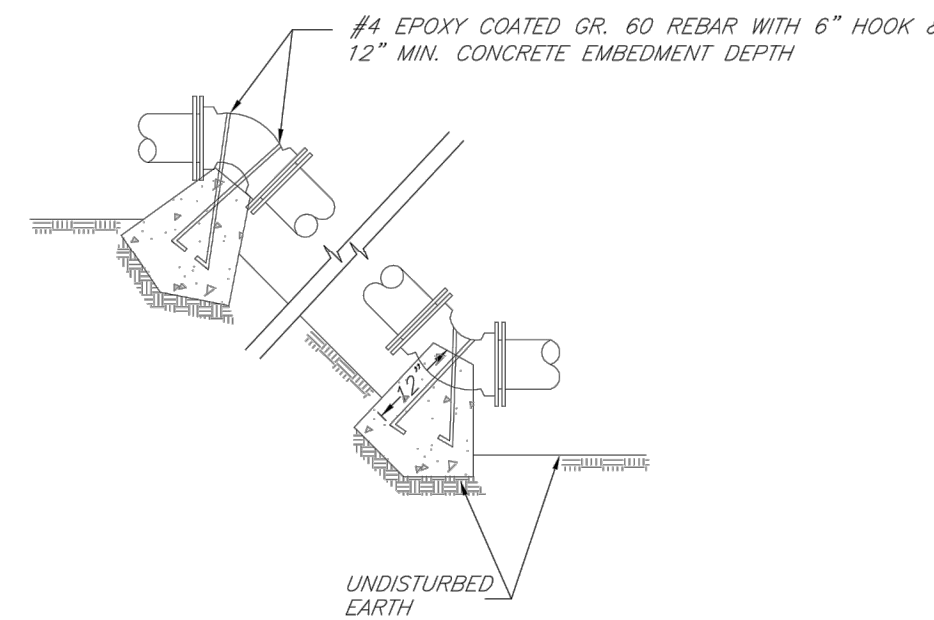

LEE'S SUMMIT MISSOURI
 PUBLIC WORKS ENGINEERING DIVISION | 1201 SE GREEN STREET | LEE'S SUMMIT, MO 64063
VERTICAL THRUST BLOCKS

Date: 02/13
 Drawn By: JN
 Checked By: DL
 File: W81-2
 Rev: 1/14

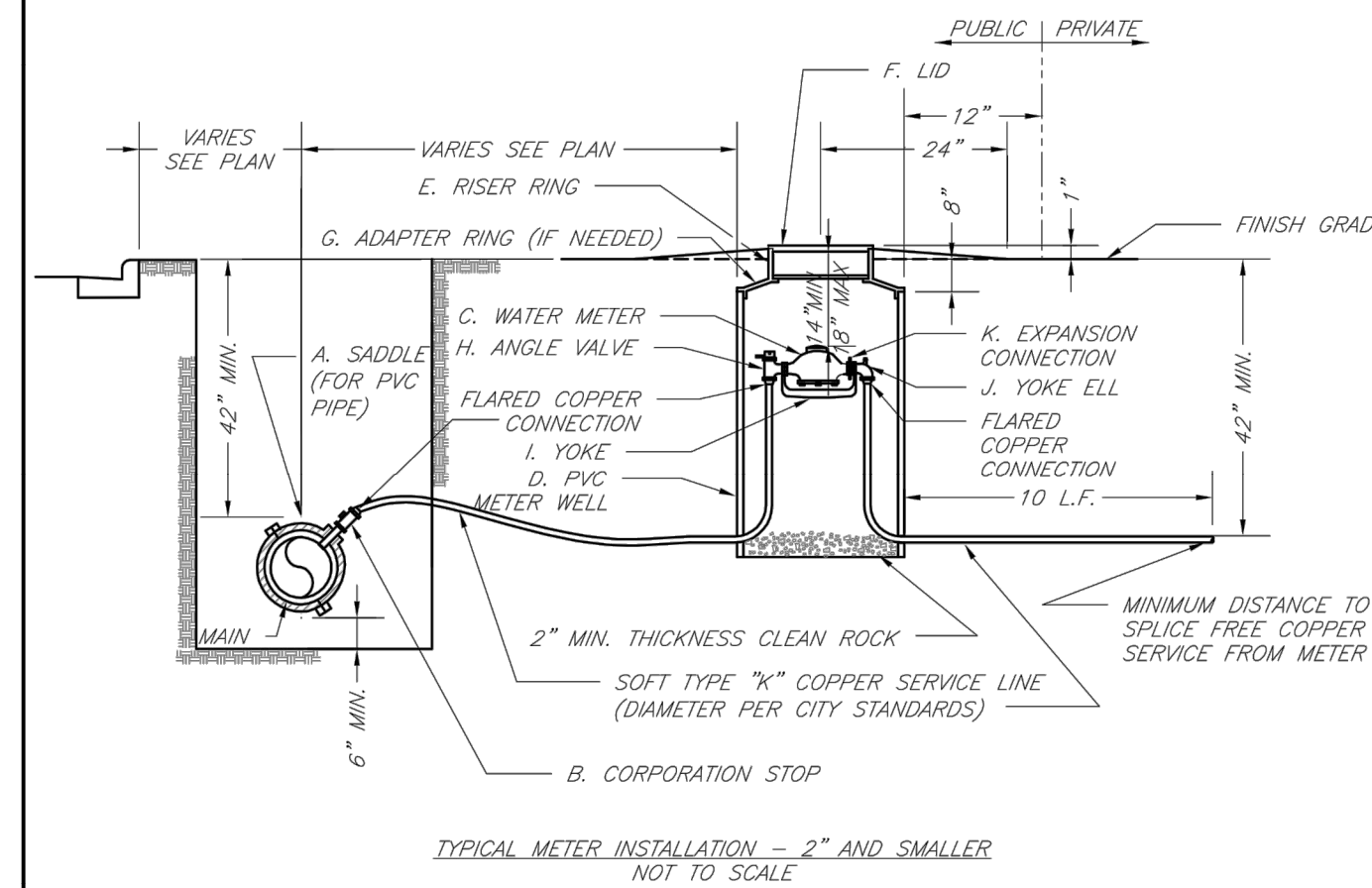

- NOTES:
 1. METER INSTALLATION SHALL NOT BE LOCATED IN AREAS SUBJECT TO VEHICULAR TRAFFIC OR IN CONCRETE PAVEMENT WITHOUT CITY APPROVAL.
 2. IF METER IS TO BE LOCATED OTHER THAN IN FRONT OF PROPERTY LINE, CITY APPROVAL SHALL BE OBTAINED.
 3. CITY TO FURNISH ITEMS A-K.
 4. NO OTHER EQUIPMENT SHALL BE INSTALLED IN THIS PIT.
 5. 42\"/>

LEE'S SUMMIT MISSOURI
 PUBLIC WORKS ENGINEERING DIVISION | 1201 SE GREEN STREET | LEE'S SUMMIT, MO 64063
SERVICE CONNECTION/METER WELL

Date: 02/13
 Drawn By: JN
 Checked By: DL
 File: W81-11
 Rev: 1/14

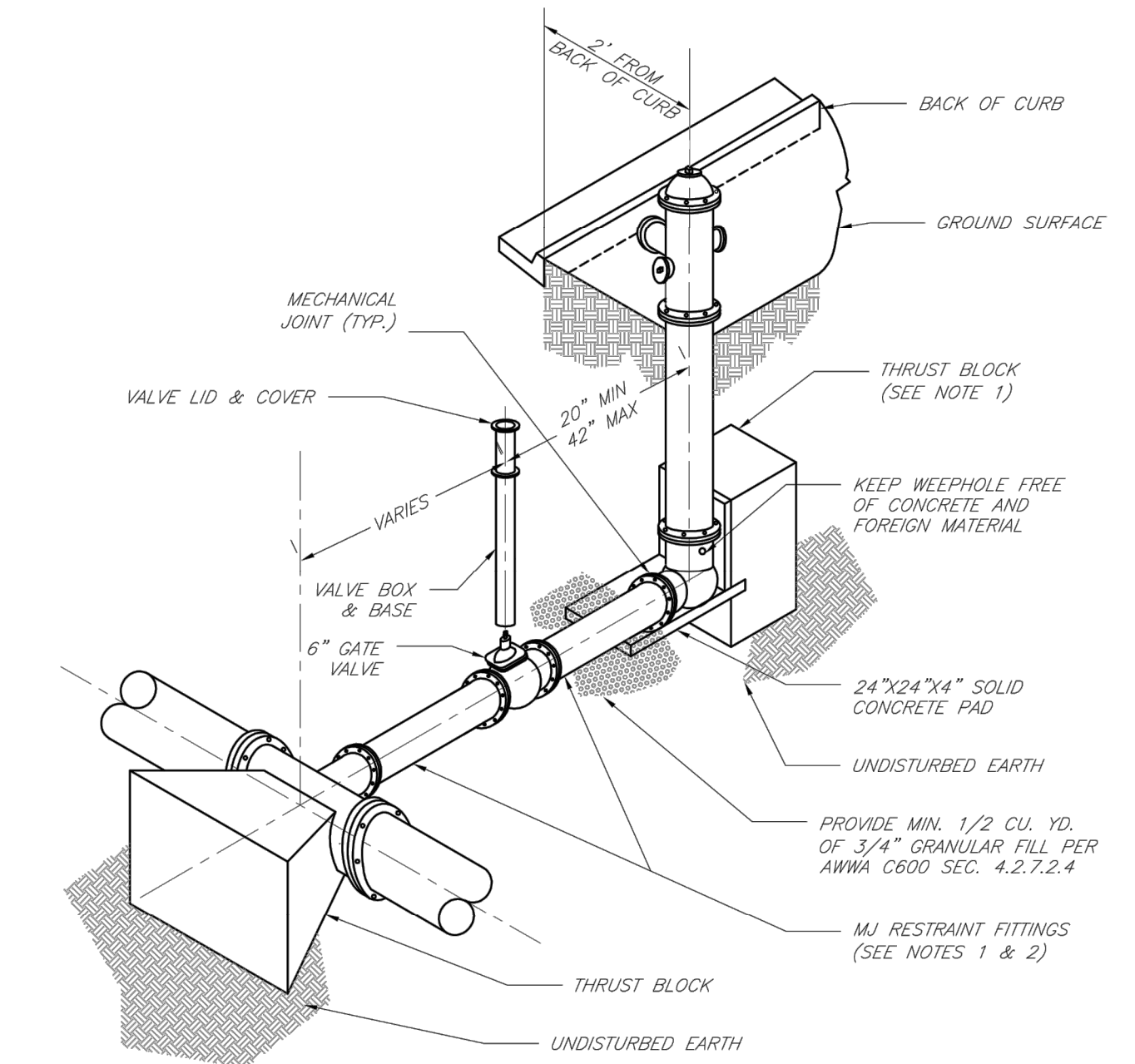

- NOTES:
 1. WHEN RETAINER GLANDS ARE USED IN LIEU OF MECHANICAL JOINT (MJ) RESTRAINT FITTINGS, HORIZONTAL THRUST BLOCKS ARE REQUIRED.
 2. GATE VALVE MAY BE BOLTED DIRECTLY TO MJ RESTRAINT TEE.
 3. SEE APPROVED PRODUCTS LIST FOR WATER UTILITIES FOR FIRE HYDRANT, VALVES, VALVE BOX LID, AND COVER.
 4. BOTTOM HYDRANT FLANGE SHALL BE 2\"/>

LEE'S SUMMIT MISSOURI
 PUBLIC WORKS ENGINEERING DIVISION | 1201 SE GREEN STREET | LEE'S SUMMIT, MO 64063
HYDRANT INSTALLATION - STRAIGHT SET

Date: 02/13
 Drawn By: JN
 Checked By: DL
 File: W81-7
 Rev: 1/14

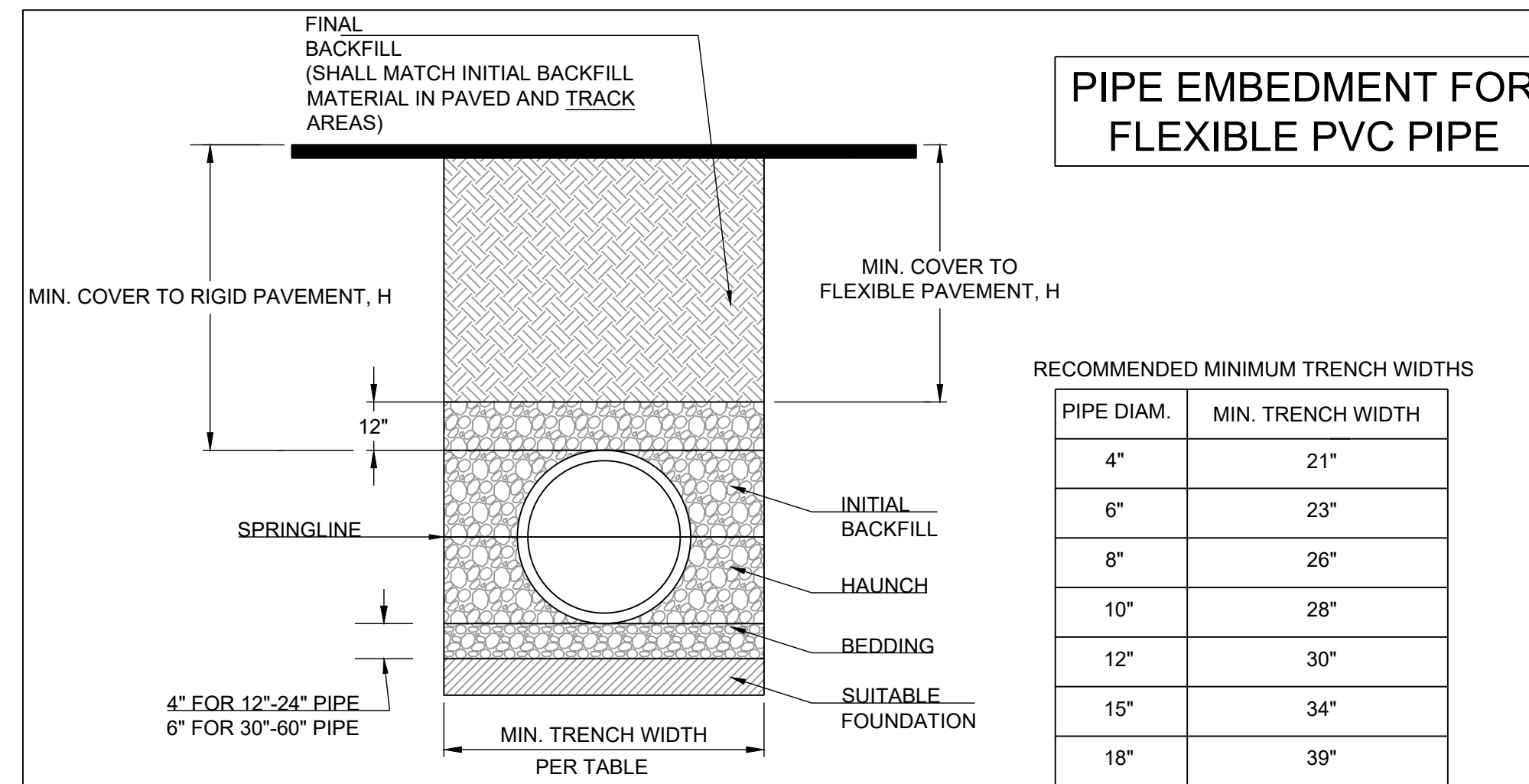

RECOMMENDED MINIMUM TRENCH WIDTHS

PIPE DIAM.	MIN. TRENCH WIDTH
4"	21"
6"	23"
8"	26"
10"	28"
12"	30"
15"	34"
18"	39"
24"	48"
30"	56"
36"	64"
42"	72"
48"	80"
54"	88"
60"	96"

MINIMUM RECOMMENDED COVER BASED ON VEHICLE LOADING CONDITIONS

PIPE DIAM.	SURFACE LIVE LOADING CONDITION	
	H-25	HEAVY CONSTRUCTION (75T AXLE LOAD) *
12" - 48"	12"	48"
54" - 60"	24"	60"

* VEHICLES IN EXCESS OF 75T MAY REQUIRE ADDITIONAL COVER

- NOTES:
 1. ALL PIPE SYSTEMS SHALL BE INSTALLED IN ACCORDANCE WITH ASTM D2321, "STANDARD PRACTICE FOR UNDERGROUND INSTALLATION OF THERMOPLASTIC PIPE FOR SEWERS AND OTHER GRAVITY FLOW APPLICATIONS", LATEST EDITION.
 2. MEASURES SHOULD BE TAKEN TO PREVENT MIGRATION OF NATIVE FINES INTO BACKFILL MATERIAL, WHEN REQUIRED.
 3. FOUNDATION: WHERE THE TRENCH BOTTOM IS UNSTABLE, THE CONTRACTOR SHALL EXCAVATE TO A DEPTH REQUIRED BY THE ENGINEER AND REPLACE WITH SUITABLE MATERIAL AS SPECIFIED BY THE ENGINEER. AS AN ALTERNATIVE AND AT THE DISCRETION OF THE DESIGN ENGINEER, THE TRENCH BOTTOM MAY BE STABILIZED USING A GEOTEXTILE MATERIAL.
 4. BEDDING: SUITABLE MATERIAL SHALL BE CLASS I, II OR III. THE CONTRACTOR SHALL PROVIDE DOCUMENTATION FOR MATERIAL SPECIFICATION TO ENGINEER. UNLESS OTHERWISE NOTED BY THE ENGINEER, MINIMUM BEDDING THICKNESS SHALL BE 4" (100mm) FOR 4"-24" (100mm-600mm); 6" (150mm) FOR 30"-60" (750mm-900mm).
 5. INITIAL BACKFILL: SUITABLE MATERIAL SHALL BE CLASS I, II OR III IN THE PIPE ZONE EXTENDING NOT LESS THAN 6" ABOVE CROWN OF PIPE. THE CONTRACTOR SHALL PROVIDE DOCUMENTATION FOR MATERIAL SPECIFICATION TO ENGINEER. MATERIAL SHALL BE INSTALLED AS REQUIRED IN ASTM D2321, LATEST EDITION.
 6. MINIMUM COVER: MINIMUM COVER, H, IN NON-TRAFFIC APPLICATIONS (GRASS OR LANDSCAPE AREAS) IS 12" FROM THE TOP OF PIPE TO GROUND SURFACE. ADDITIONAL COVER MAY BE REQUIRED TO PREVENT FLOATION. FOR TRAFFIC APPLICATIONS, MINIMUM COVER, H, IS 12" UP TO 48" DIAMETER PIPE AND 24" OF COVER FOR 54"-60" DIAMETER PIPE, MEASURED FROM TOP OF PIPE TO BOTTOM OF FLEXIBLE PAVEMENT OR TO TOP OF RIGID PAVEMENT.

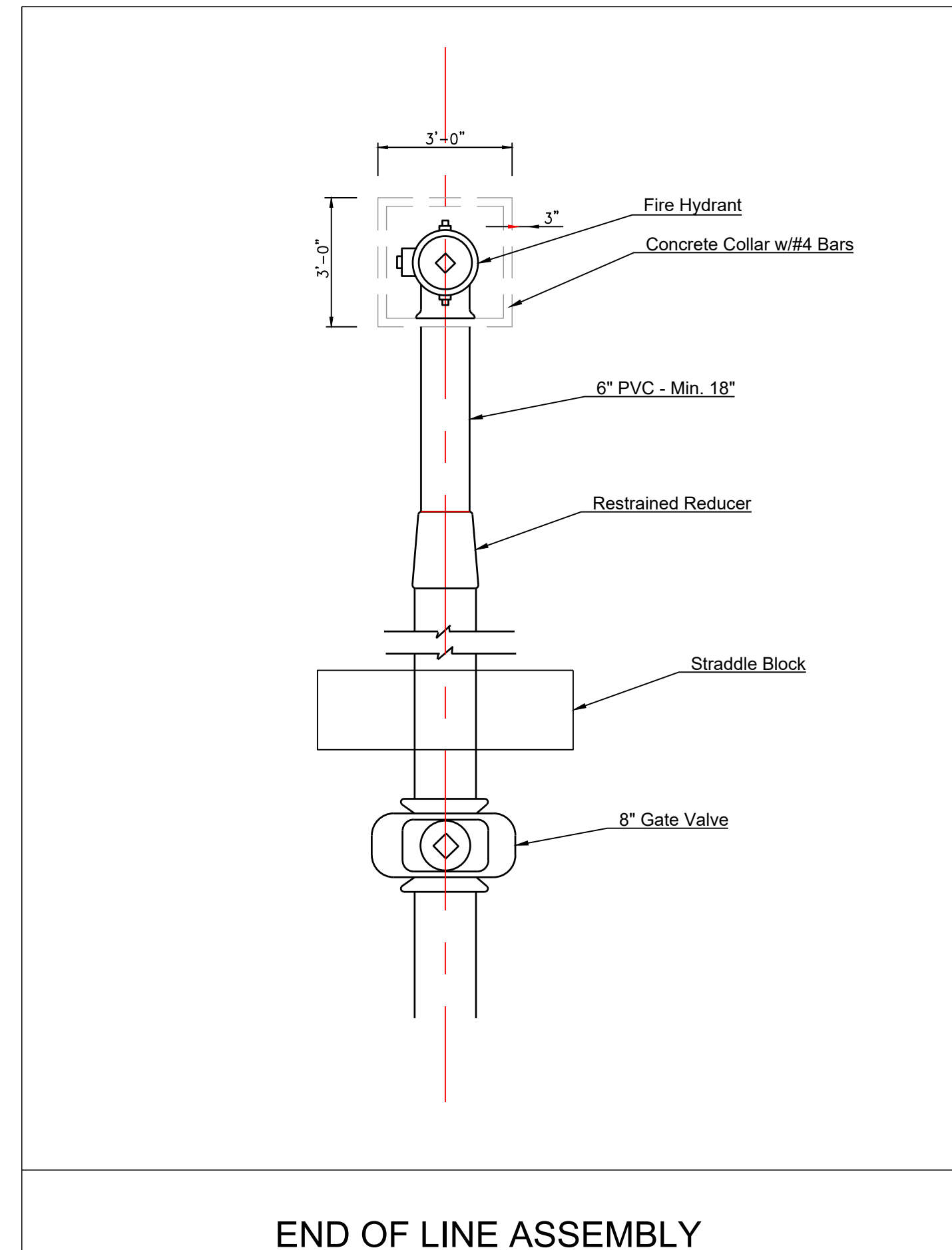

END OF LINE ASSEMBLY

REVISION DATE	DESCRIPTION
01/24/2022	Per City Comments dated 11/19/2022
04/20/2022	Per City Comments dated 02/15/2022
05/11/2022	Per City Comments dated 05/24/2022
03/03/2022	Per City Comments dated 05/01/2022

DRAWN BY: MBH
 CHECKED BY: JLL
 DATE PREPARED: 11/05/2021
 PROJ. NUMBER: 21-130