

FINAL STORMWATER REPORT

HOOK FARMS SECOND PLAT

Prepared for:

Hunt Midwest Real Estate Development, Inc.
8300 NE Underground Drive
Kansas City, MO 64161
Contact: Aaron Schmidt

Prepared by:

Olsson
1301 Burlington Street, Suite 100
North Kansas City, MO 64116
Contact: Julie Sellers, P.E.

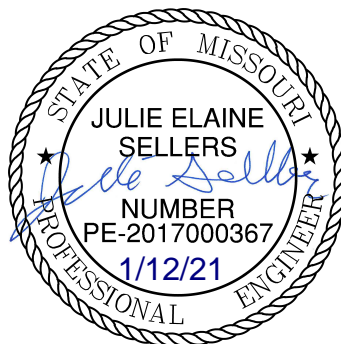

January 2021
Olsson Project No. B19-4061



I. GENERAL INFORMATION

This report is being submitted as a summary of the stormwater drainage design for Hook Farms Second Plat, located at the northwest corner of SW Hook Road and SW Pryor Road in the City of Lee's Summit, Jackson County, Missouri. A preliminary stormwater study has previously been completed by Olsson named "Hook Farms Preliminary Stormwater Drainage Study" (Preliminary Study) dated March 2019. The purpose of this report is to verify that the final design of the Second Plat meets the analysis and intent of the Preliminary Study. The full Preliminary Study can be found in Appendix C of this report.

II. HOOK FARMS SECOND PLAT

A. Site Description

Hook Farms Second Plat encompasses 26.57 acres of the Hook Farms development and includes 79 single family home lots and one tract along with the public infrastructure to support those lots. Generally, the drainage patterns, proposed grading, and proposed impervious area in the current design remains the same as the Preliminary Study. All assumptions and statements within the Preliminary Study remain the same. Further analysis on the water quality basin and storm sewer is detailed below.

B. Water Quality Basin

Per the Preliminary Study, proposed detention required is limited to the water quality storm event. The water quality basin located in the Hook Farms Second Plat area is named WQB 4 in the Preliminary Study. The volume required is 24,503 cubic feet and the tributary area planned is 24.46 acres. The proposed pond is in the same location and has 91,078 cubic feet of volume and 19.63 acres tributary to it. The water quality volume will be held in the pond for 40 hours past the peak time. The release rate from the pond will be controlled by a 3"x3" square orifice cut into a steel plate on the outlet control structure. This basin exceeds the requirements of the Preliminary Study. Final design and supporting calculations for this water quality pond can be found in Appendix B of this report.

C. Storm Sewer System

A public storm sewer system is proposed to convey runoff generated on-site to the water quality basin. This storm sewer system consists of HDPE pipe with sizes ranging from 15" to 36", and several curb and field inlets to capture runoff. The system is designed to capture and convey the 10-year storm event with HGL below the pipe crown and no more than 1 cfs inlet bypass flow across intersections. Final design and calculations for the storm sewer system can be found in Appendix B of this report.

III. CONCLUSIONS AND RECCOMENDATIONS

The calculated peak runoff rates and volume of runoff generated for the Hook Farms Second Plat development will be equal to or lower than the pre-development peak runoff rates planned in the Preliminary Study. Storm sewer systems proposed will convey runoff safely to the water quality basin for treatment before being released to the surrounding creeks. Drainage patterns, impervious areas, and all other assumptions made in the Preliminary Study are confirmed to be the same with the current design of the second plat. Based on the information provided, Olsson requests approval of this final stormwater report for the proposed development of Hook Farms Second Plat.

APPENDIX A

Hook Farms Second Plat Water Quality Basin Calculations

DWG: F:\2019\4001-4500\019-4061-b\40-design\AutoCAD\final plans\Sheets\GNCV\Street & Storm Plans\C_DBP01_B194061.dwg
 DATE: Jan 12, 2021 11:16am XREFS: C:\PTBLK_B194061 C:\XBASE_B194061 C:\PBASE_B194061 C:\PBNDY_B194061 C:\PUTIL_B194061 C:\FBASE_B194061
 USER: cabdjalivey

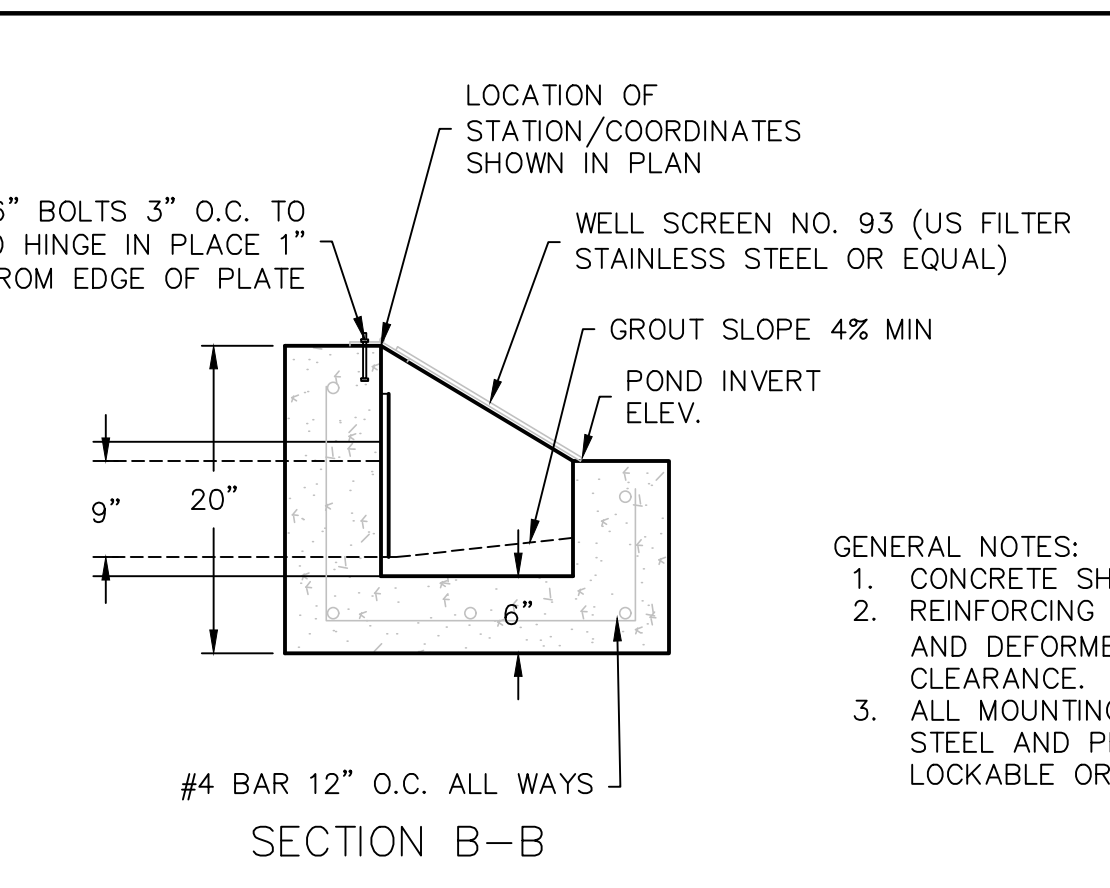
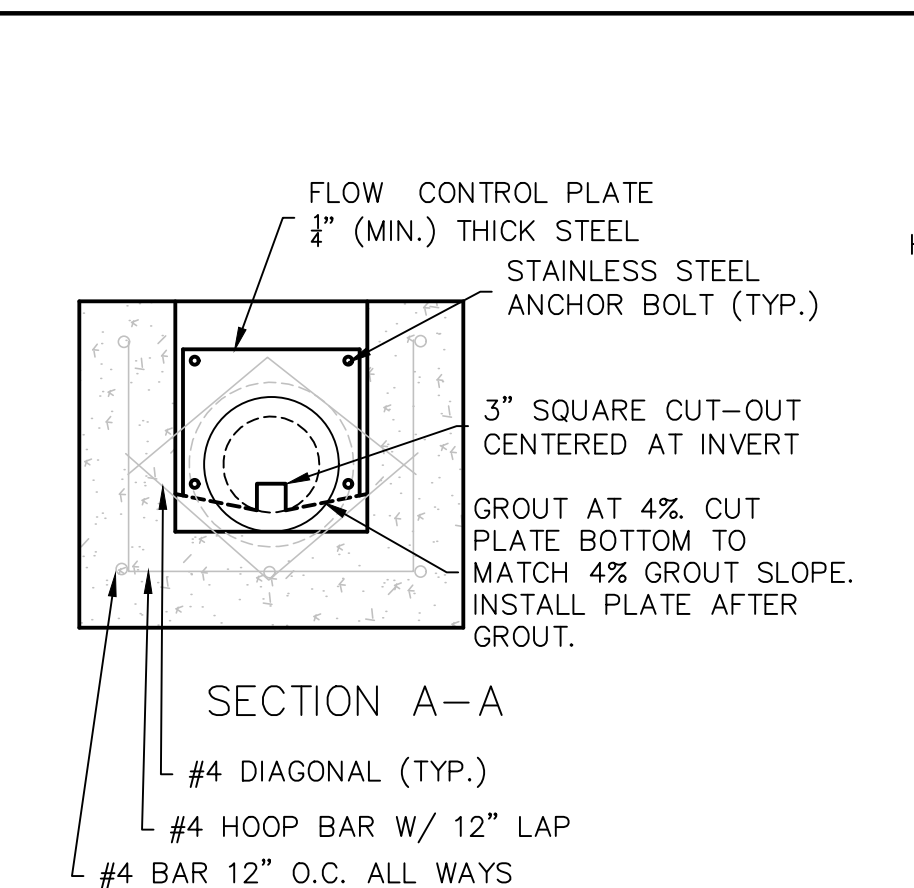
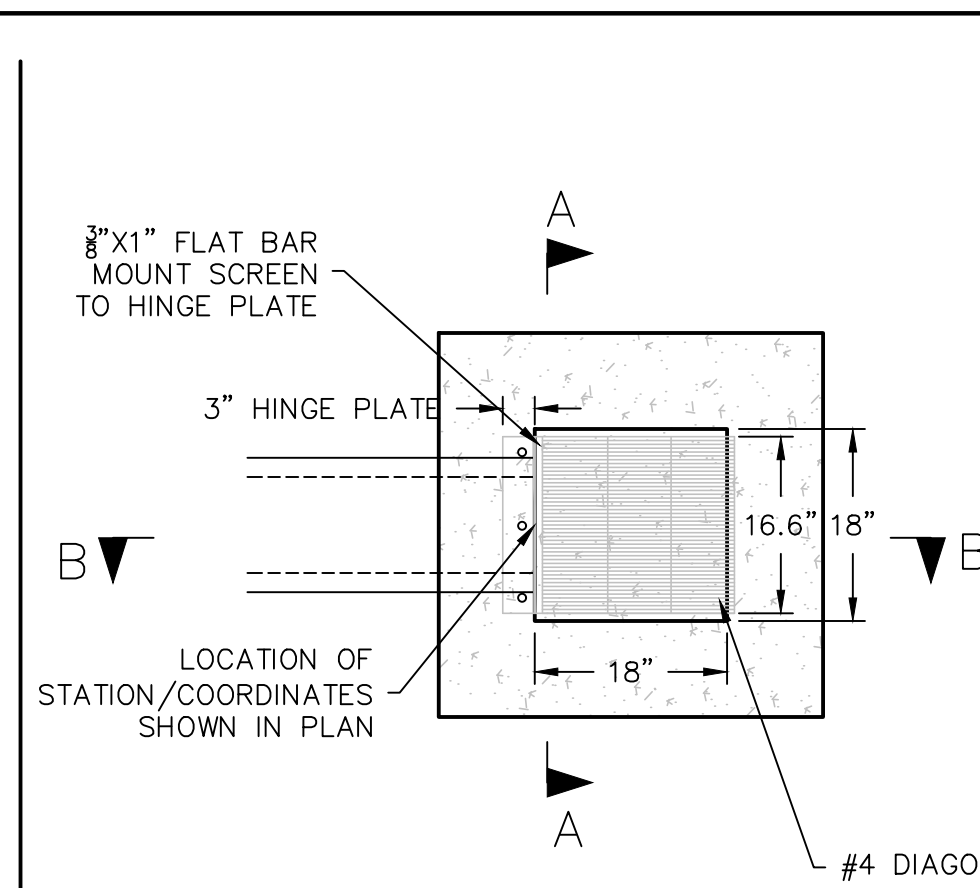

01 WATER QUALITY BASIN OULET STRUCTURE

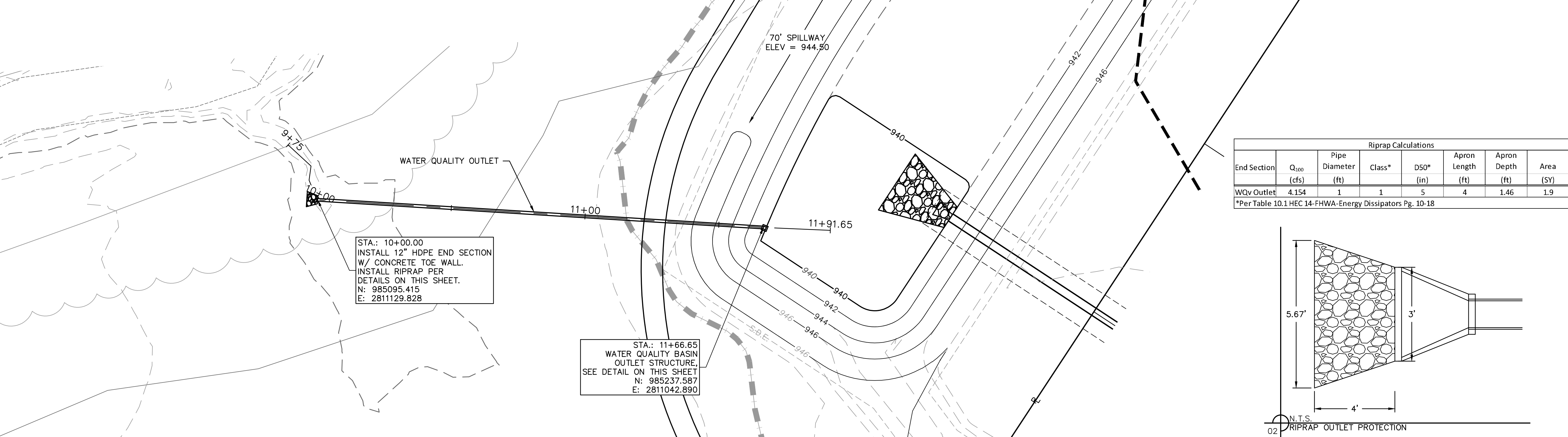
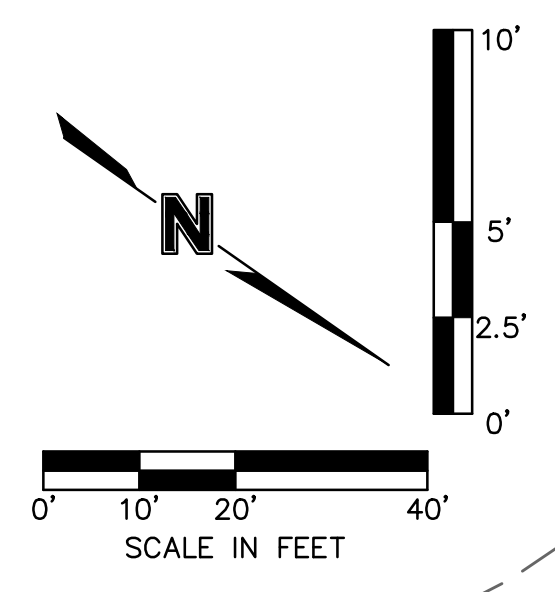
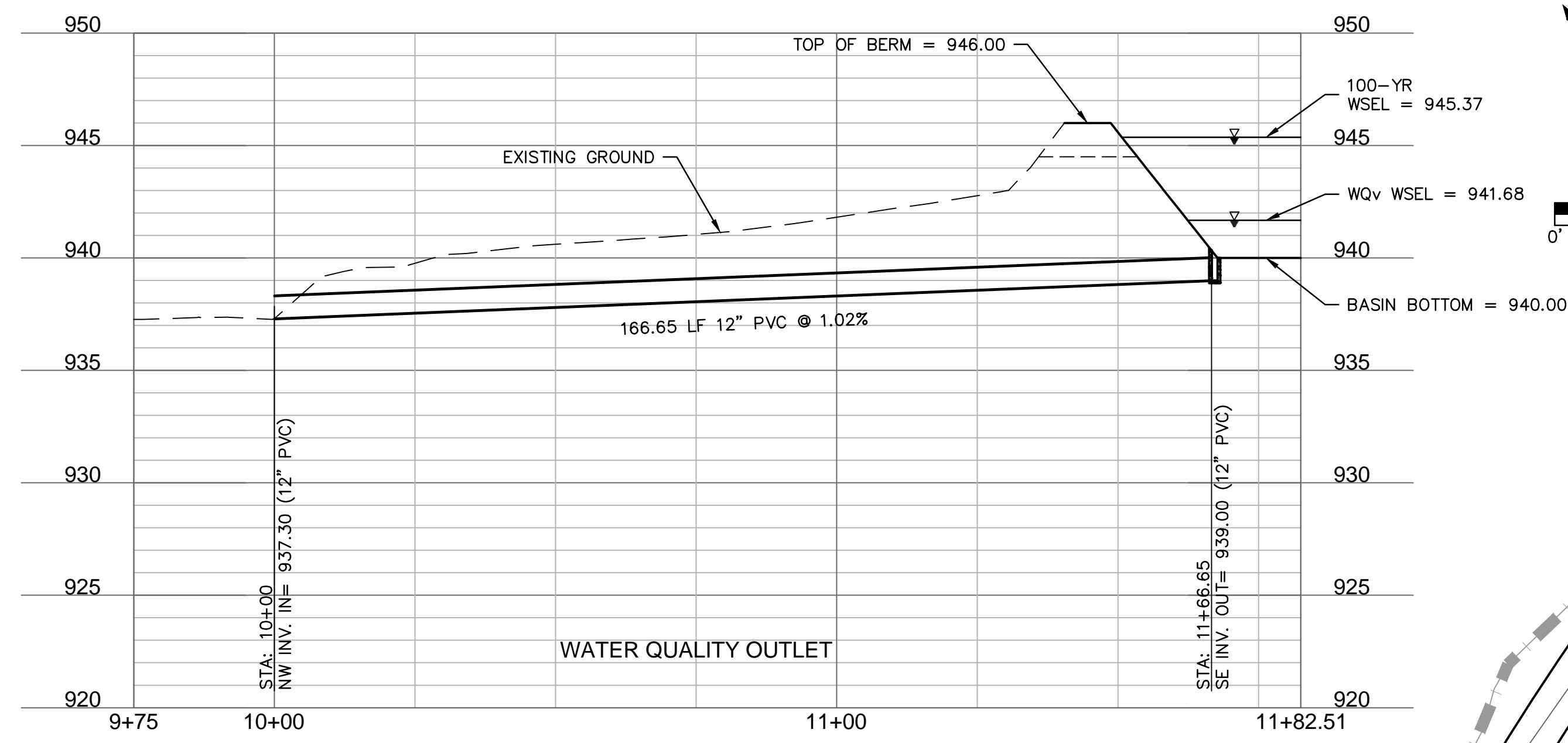

STA.: 10+00.00
 INSTALL 12" HDPE END SECTION
 W/ CONCRETE TOE WALL.
 INSTALL RIPRAP PER
 DETAILS ON THIS SHEET.
 N: 985095.415
 E: 2811129.828

STA.: 11+66.65
 WATER QUALITY BASIN
 OULET STRUCTURE,
 SEE DETAIL ON THIS SHEET
 N: 985237.587
 E: 2811042.890

Riprap Calculations							
End Section	Q ₁₀₀ (cfs)	Pipe Diameter (ft)	Class*	D50* (in)	Apron Length (ft)	Apron Depth (ft)	Area (SY)
WQv Outlet	4.154	1	1	5	4	1.46	1.9

*Per Table 10.1 HEC 14-FHWA-Energy Dissipators Pg. 10-18

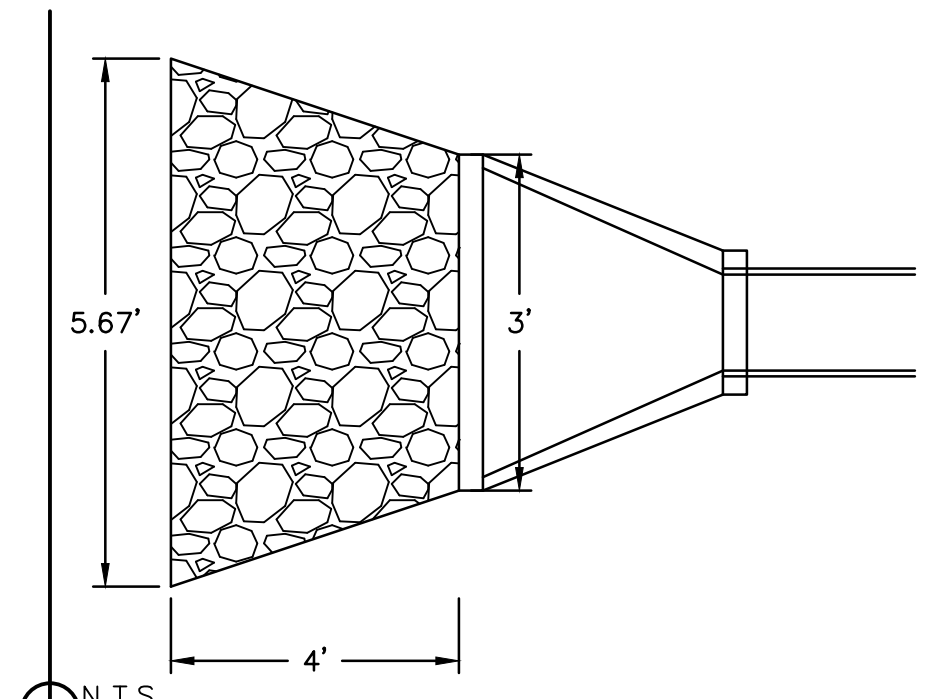

02 RIPRAP OULET PROTECTION

Olsson - Civil Engineering
 Missouri Certificate of Authority #001592
 1301 Burlington Street
 North Kansas City, MO 64116
 TEL 816.361.1177
 FAX 816.361.1888
 www.olsson.com

REVISIONS

REV. NO.	DATE	REVISIONS DESCRIPTION	BY

WATER QUALITY BASIN PLAN
 STREET & STORM SEWER PLANS

HOOK FARMS
 SECOND PLAT

LEE'S SUMMIT, MO

2021

drawn by: B.M.W./A.A.
 checked by: B.M.W./A.A.
 designed by: B.M.W./A.A.
 QA/QC by: J.E.S.
 project no.: B19-4061
 date: 01-08-2021

SHEET
 C142

Hydrograph Report

Hydraflow Hydrographs Extension for Autodesk® Civil 3D® by Autodesk, Inc. v2020

Tuesday, 01 / 12 / 2021

Hyd. No. 1

Water Quality Basin 4

Hydrograph type	= SCS Runoff	Peak discharge	= 7.799 cfs
Storm frequency	= 1 yrs	Time to peak	= 12.03 hrs
Time interval	= 2 min	Hyd. volume	= 22,526 cuft
Drainage area	= 19.630 ac	Curve number	= 83
Basin Slope	= 0.0 %	Hydraulic length	= 0 ft
Tc method	= User	Time of conc. (Tc)	= 12.30 min
Total precip.	= 1.37 in	Distribution	= Type II
Storm duration	= 24 hrs	Shape factor	= 484

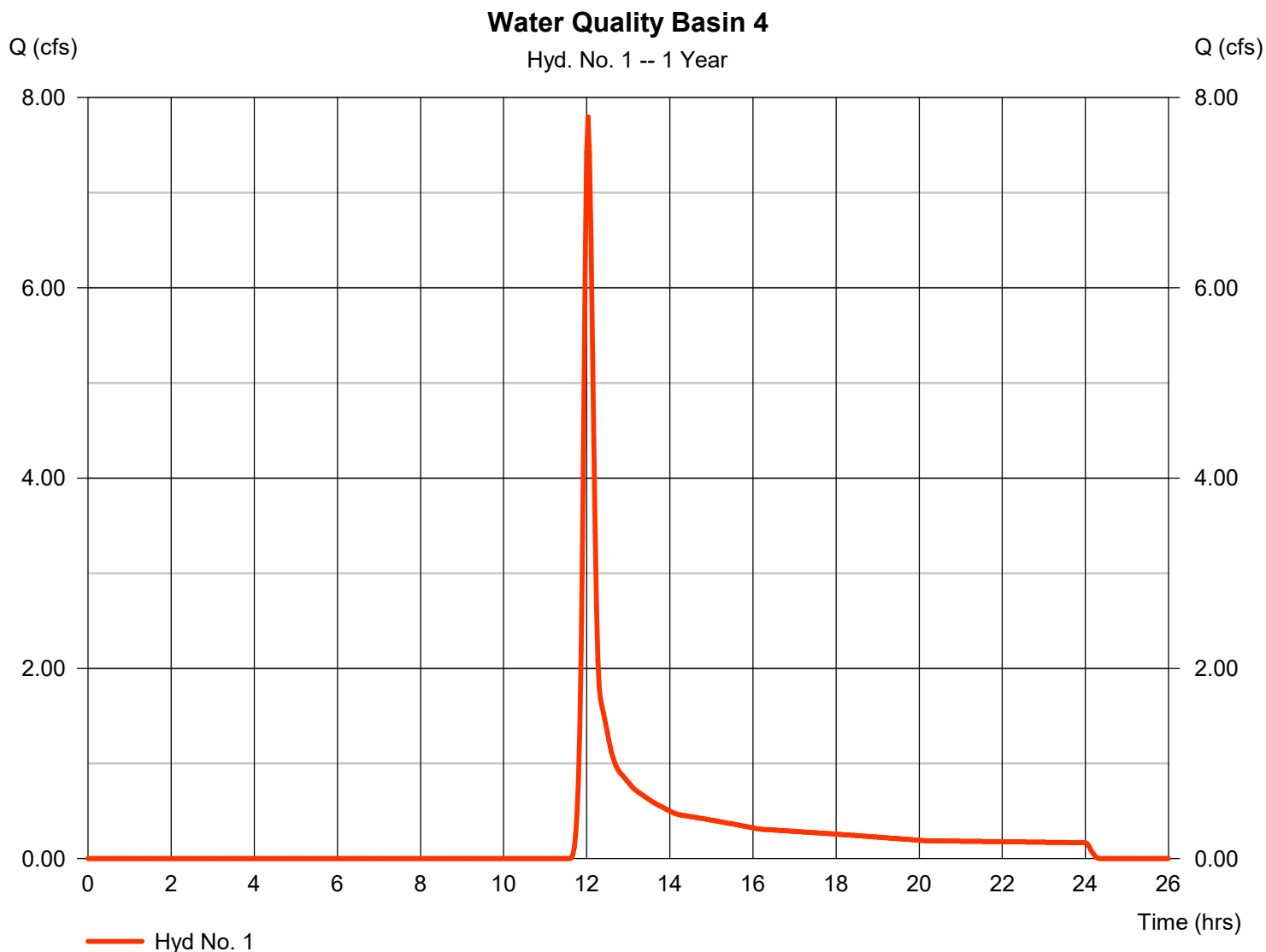

Hydrograph Report

Hydraflow Hydrographs Extension for Autodesk® Civil 3D® by Autodesk, Inc. v2020

Tuesday, 01 / 12 / 2021

Hyd. No. 2

Water Quality Basin 4

Hydrograph type	= Reservoir	Peak discharge	= 0.294 cfs
Storm frequency	= 1 yrs	Time to peak	= 16.70 hrs
Time interval	= 2 min	Hyd. volume	= 22,498 cuft
Inflow hyd. No.	= 1 - Water Quality Basin 4	Max. Elevation	= 941.68 ft
Reservoir name	= Water Quality Basin 4	Max. Storage	= 12,177 cuft

Storage Indication method used.

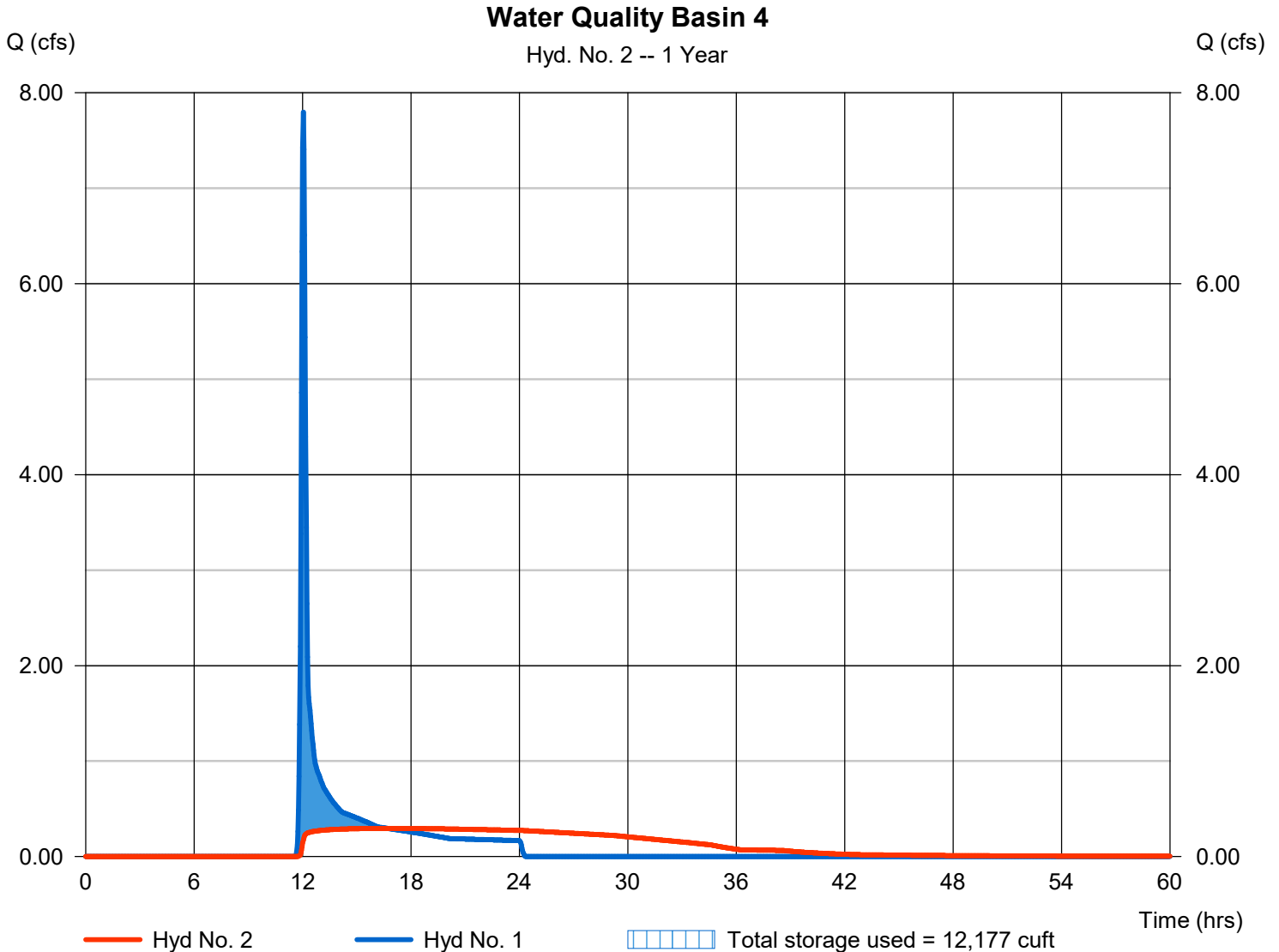

Hydrograph Report

Hyd. No. 2

Water Quality Basin 4

Hydrograph type	= Reservoir	Peak discharge	= 0.294 cfs
Storm frequency	= 1 yrs	Time to peak	= 16.70 hrs
Time interval	= 2 min	Hyd. volume	= 22,498 cuft
Inflow hyd. No.	= 1 - Water Quality Basin 4	Max. Elevation	= 941.68 ft
Reservoir name	= Water Quality Basin 4	Max. Storage	= 12,177 cuft

Storage Indication method used.

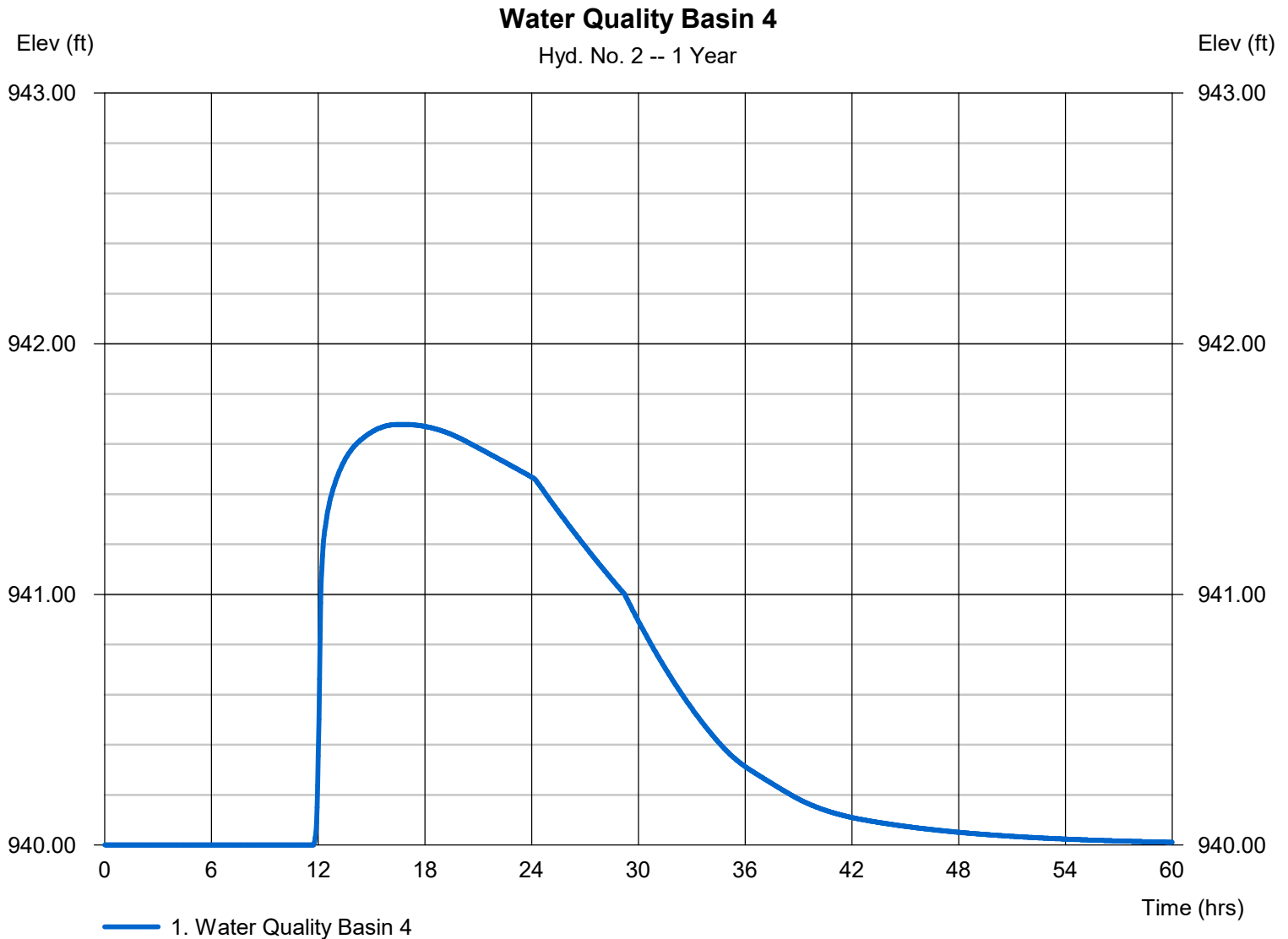

APPENDIX B

Hook Farms Second Plat Storm Sewer Calculations

DWG: F:\2019\4001-4500\019-4061-b\40-design\AutoCAD\final plans\Sheets\GNCV\Street & Storm Plans\C_STM01_B194061.dwg
 DATE: Jan 12, 2021 11:13am XREFS: C_XBASE_B194061 C_PBASE_B194061 C_PENDY_B194061 C_PSTRM_B194061 C_PTBLK_B194061 C_PUTIL_B194061 USER: cabdgalivey

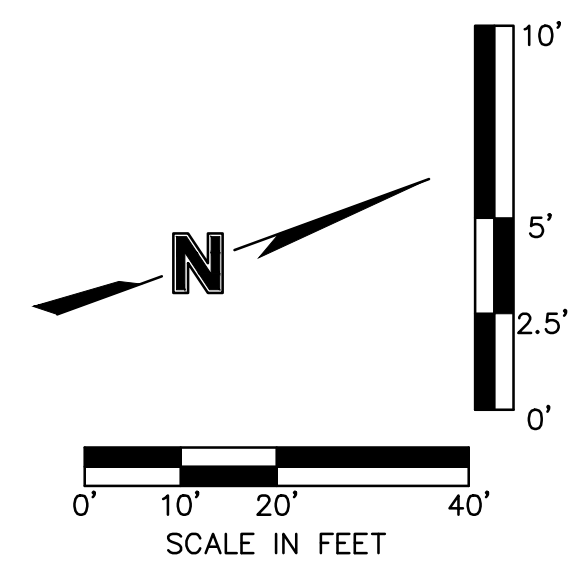
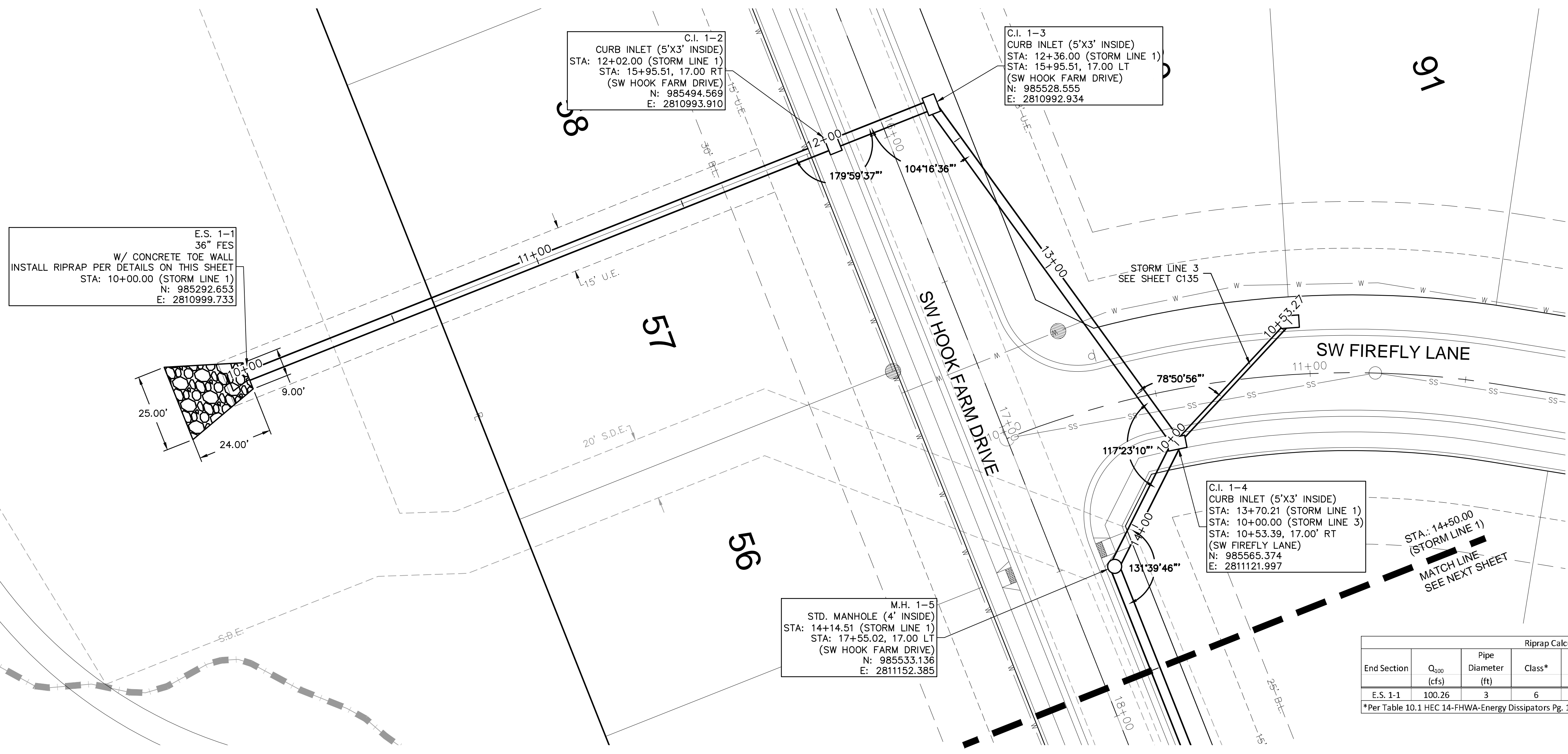

Riprap Calculations							
End Section	Q ₁₀₀ (cfs)	Pipe Diameter (ft)	Class*	D50* (in)	Apron Length (ft)	Apron Depth (ft)	Area (SY)
E.S. 1-1	100.26	3	6	22	24	3.67	45.3

*Per Table 10.1 HEC 14-FHWA-Energy Dissipators Pg. 10-18

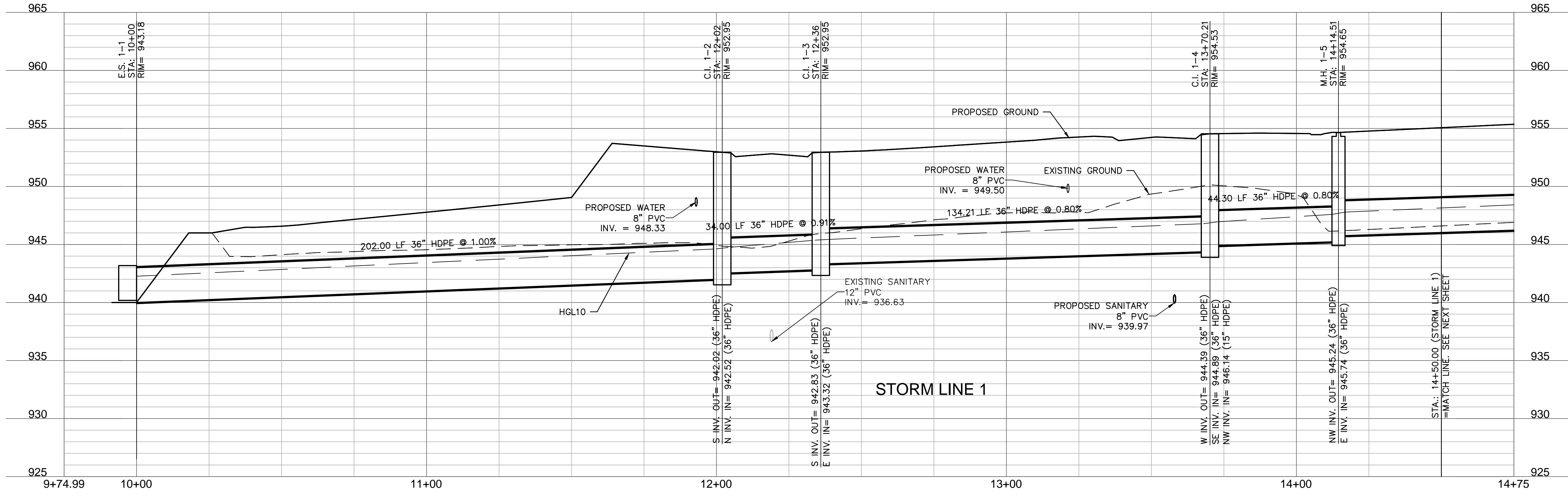

Olsson - Civil Engineering
 Missouri Certificate of Authority #001592
 1301 Burlington Street
 North Kansas City, MO 64116
 TEL 816.361.1177
 FAX 816.361.1888
 www.olson.com

REVISIONS

REV. NO.	DATE	REVISIONS DESCRIPTION	BY

STORM SEWER PLAN & PROFILE (LINE 1)
 STREET & STORM SEWER PLANS

HOOK FARMS
 SECOND PLAT
 2021

LEE'S SUMMIT, MO

SHEET
 C131

drawn by: B.M.W./A.A.
 checked by: B.M.W.
 designed by: B.M.W./A.A.
 QA/QC by: J.E.S.
 project no.: B19-4061
 date: 01-08-2021

DWG: F:\2019\4001-4500\019-4061-b\40-design\AutoCAD\final plans\Storm Plans\C_STM01_B194061.dwg
 DATE: Jan 12, 2021 11:13am XREFS: C_XBASE_B194061 C_PBASE_B194061 C_PBTBLK_B194061 C_PSTRM_B194061 C_PUTIL_B194061
 USER: cabdjalivey

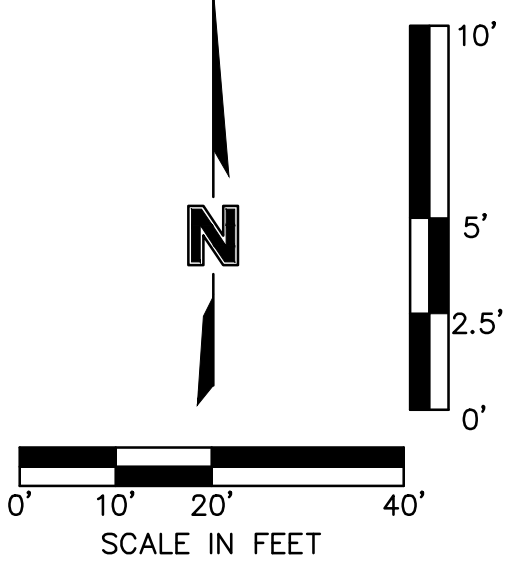
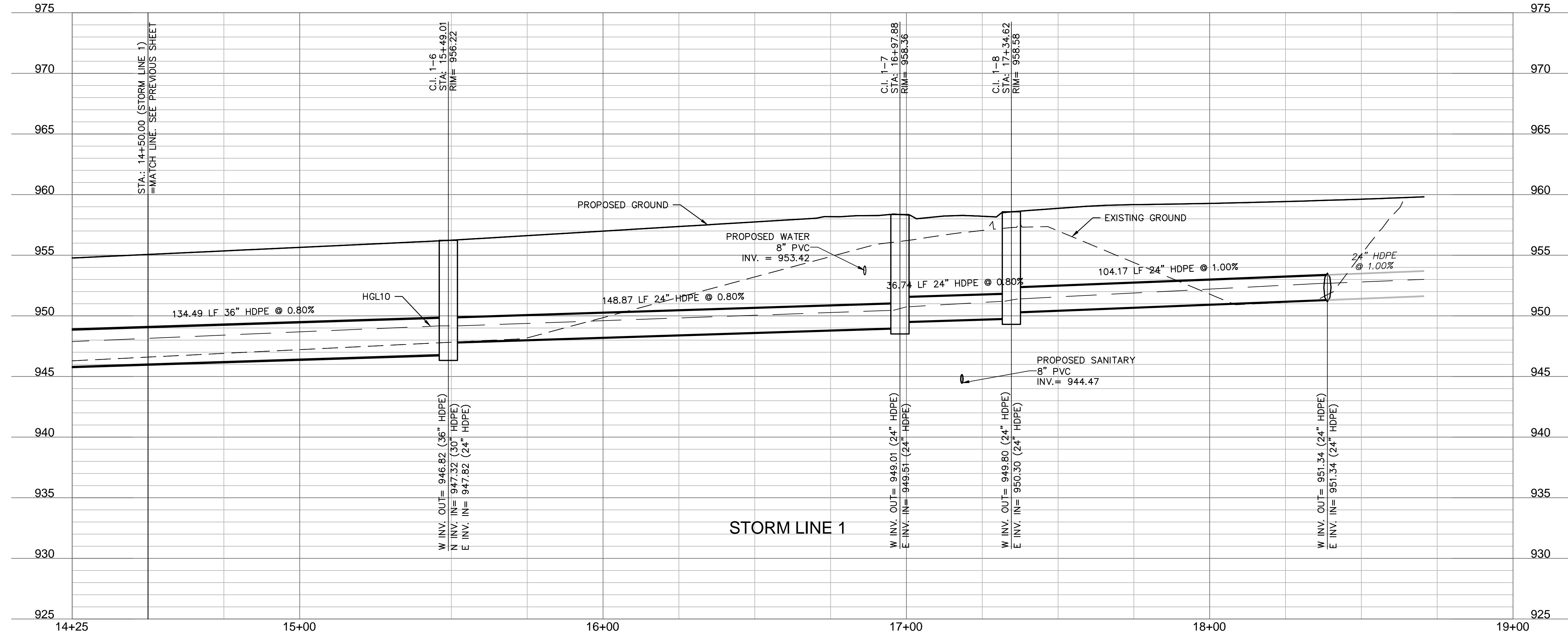
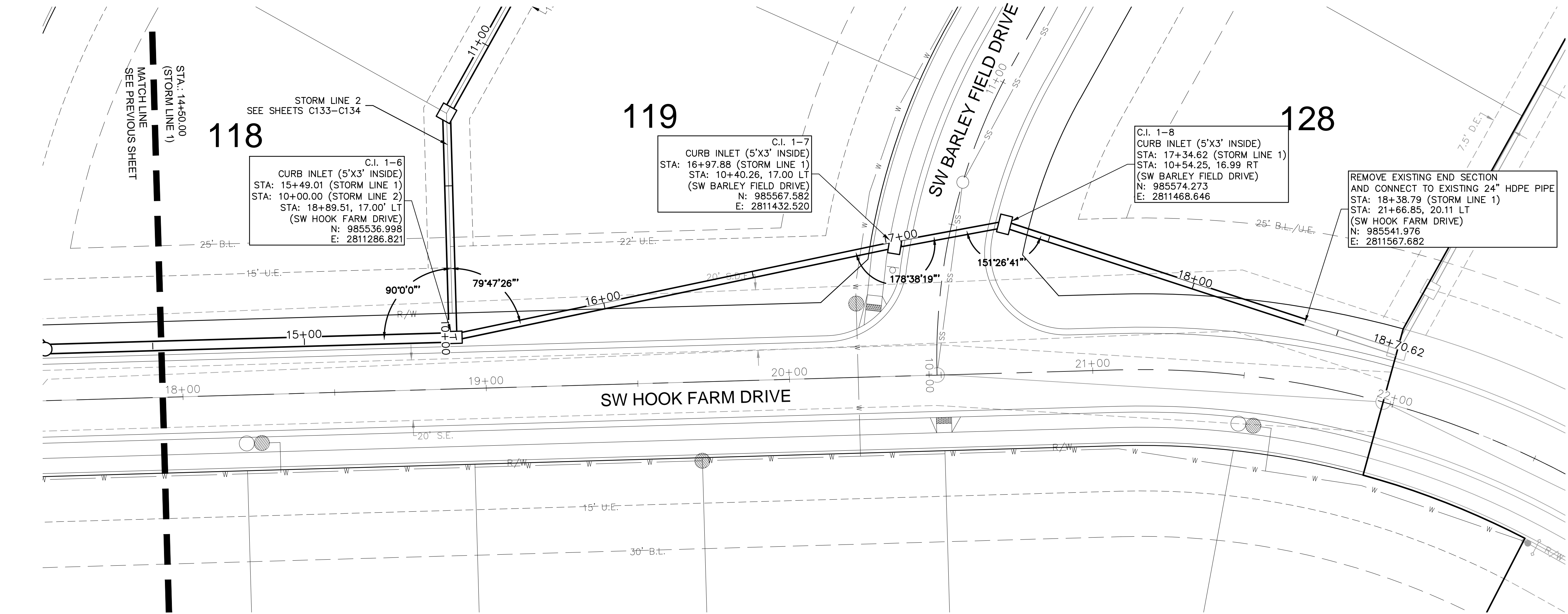

olsson
 Olsson - Civil Engineering
 Missouri Certificate of Authority #001592
 1301 Burlington Street
 North Kansas City, MO 64116
 TEL 816.361.1177
 FAX 816.361.1888
 www.olson.com

REV. NO.	DATE	REVISIONS DESCRIPTION	BY

STORM SEWER PLAN & PROFILE (LINE 1)
 STREET & STORM SEWER PLANS
 HOOK FARMS
 SECOND PLAT
 LEE'S SUMMIT, MO
 2021

drawn by: B.M.W./A.A.
 checked by: B.M.W.
 designed by: B.M.W./A.A.
 QA/QC by: J.E.S.
 project no.: B19-4061
 date: 01-08-2021

SHEET
 C132

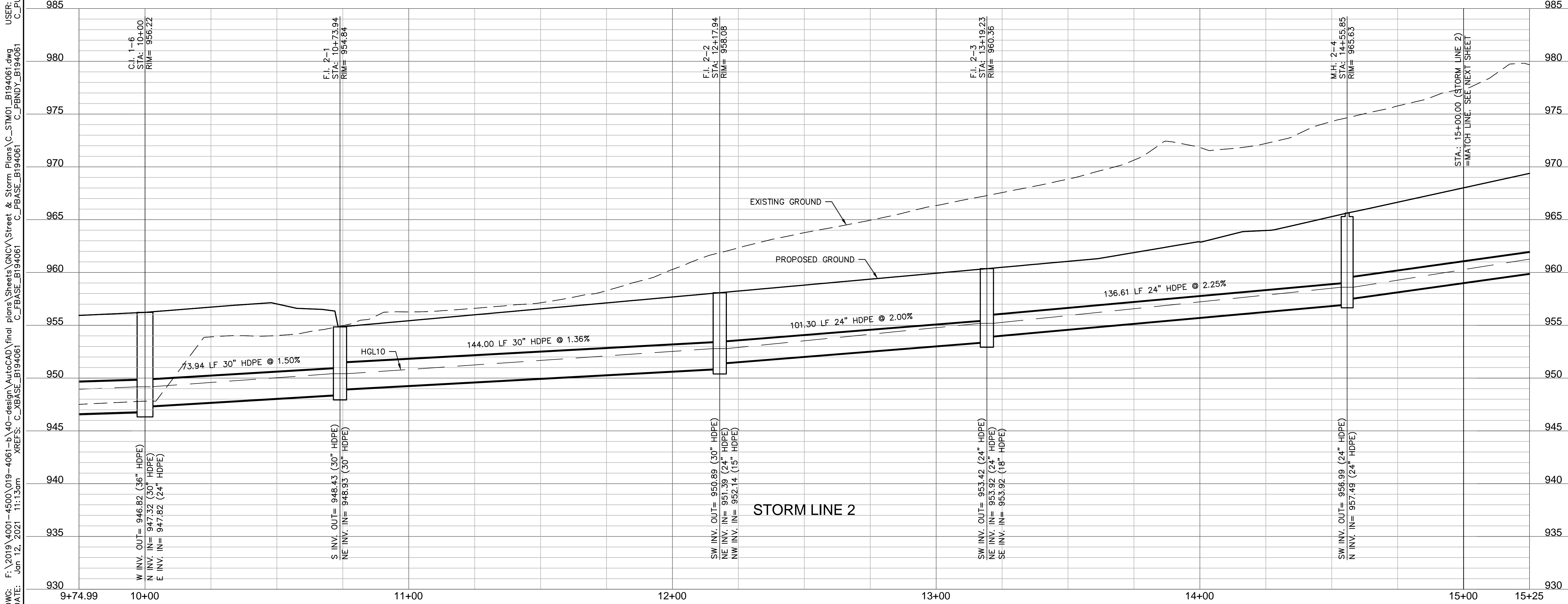
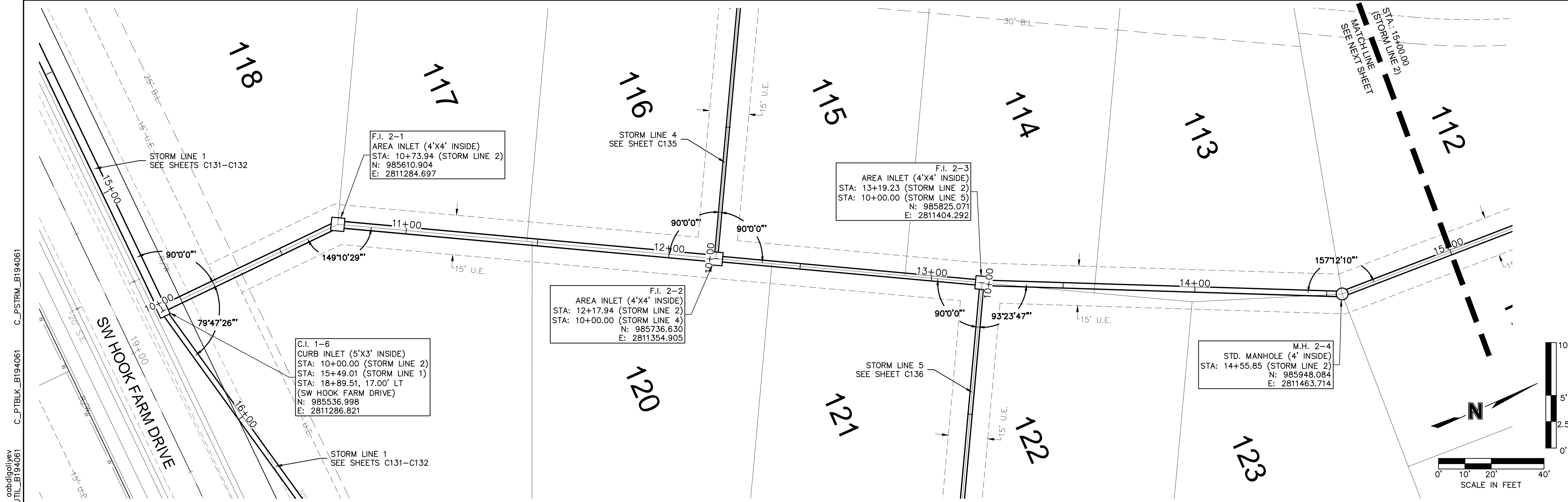

DWG: F:\2019\4001-4500\019-4061-b\40-design\AutoCAD\final plans\Storm Plans\C_STM01_B194061.dwg
 DATE: Jan 12, 2021 11:13am
 USER: acbdgalivey
 XREFS: C:\BASE_B194061

Olsson - Civil Engineering
 Missouri Certificate of Authority #001592
 1301 Burlington Street
 North Kansas City, MO 64116
 TEL 816.361.1177
 FAX 816.361.1888
 www.olson.com

REV. NO.	DATE	REVISIONS DESCRIPTION

STORM SEWER PLAN & PROFILE (LINE 2)
STREET & STORM SEWER PLANS

HOOK FARMS
 SECOND PLAT

LEE'S SUMMIT, MO

2021

drawn by: B.M.W./A.A.
 checked by: B.M.W.
 designed by: B.M.W./A.A.
 QA/QC by: J.E.S.
 project no.: B19-4061
 date: 01-09-2021

SHEET
C133

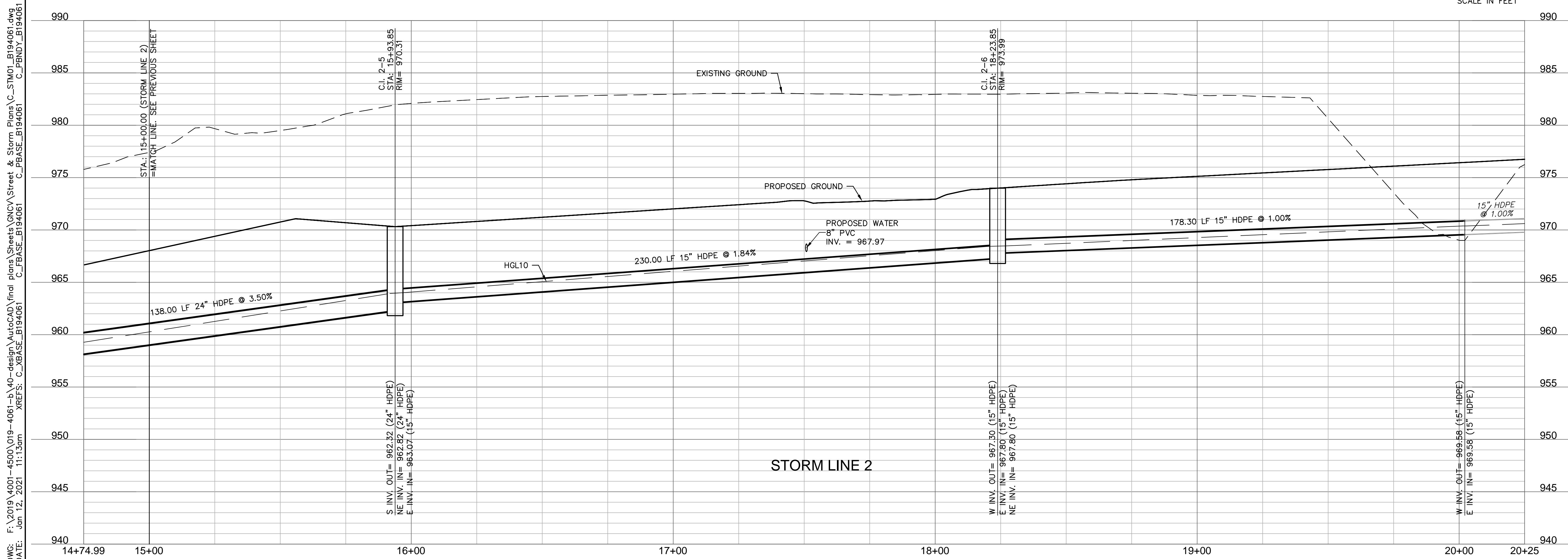
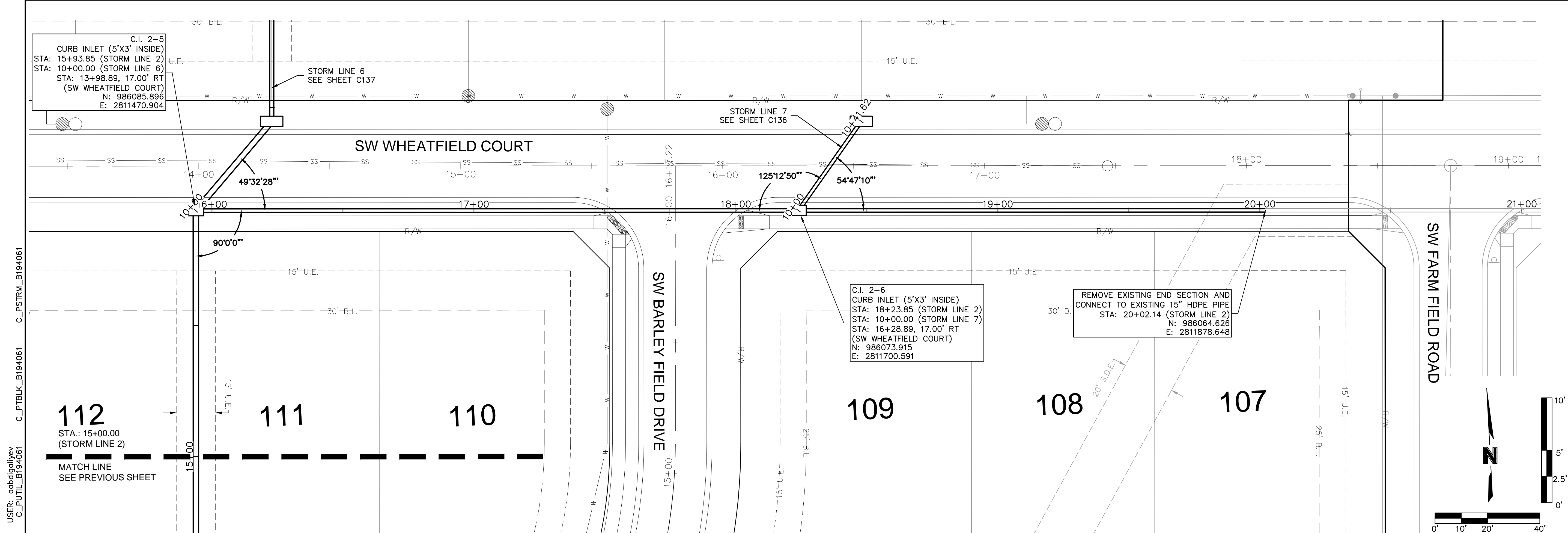

DWG: F:\2019\4001-4500\019-4061-b\40-design\AutoCAD\final plans\Storm Plans\C_STM01_B194061.dwg
 DATE: Jan 12, 2021 11:13am XREFS: C:\BASE_B194061 C:\BASE_B194061 C:\BASE_B194061 C:\BASE_B194061 C:\BASE_B194061
 USER: cabdjalivey C_PUTIL_B194061 C_PTRM_B194061 C_PTRM_B194061

REV. NO.	DATE	REVISIONS DESCRIPTION	BY

REV. NO.	DATE	REVISIONS DESCRIPTION	BY

STORM SEWER PLAN & PROFILE (LINE 2)
STREET & STORM SEWER PLANS
 HOOK FARMS
 SECOND PLAT
 LEE'S SUMMIT, MO

2021

drawn by: B.M.W./A.A.
 checked by: B.M.W.
 designed by: B.M.W./A.A.
 QA/QC by: J.E.S.
 project no.: B19-4061
 date: 01-08-2021

DWG: F:\2019\4001-4500\019-4061-b\40-design\AutoCAD\final plans\Storm Plans\C_STM02_B194061.dwg
 DATE: Jan 12, 2021 11:14am
 USER: abdigaliev
 XREFS: C_XBASE_B194061
 C_PSTRM_B194061
 C_PTBLK_B194061
 C_PBASE_B194061
 C_PBNDR_B194061

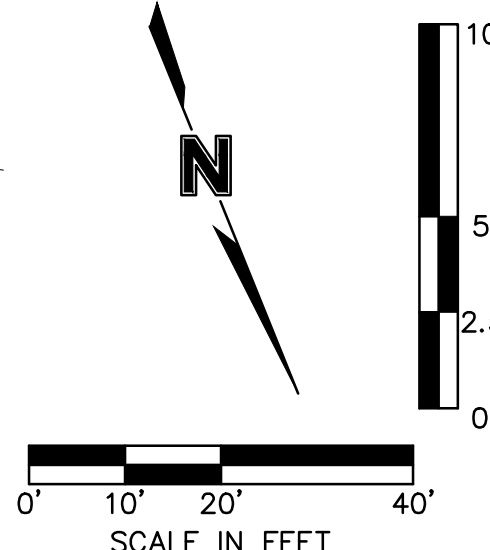
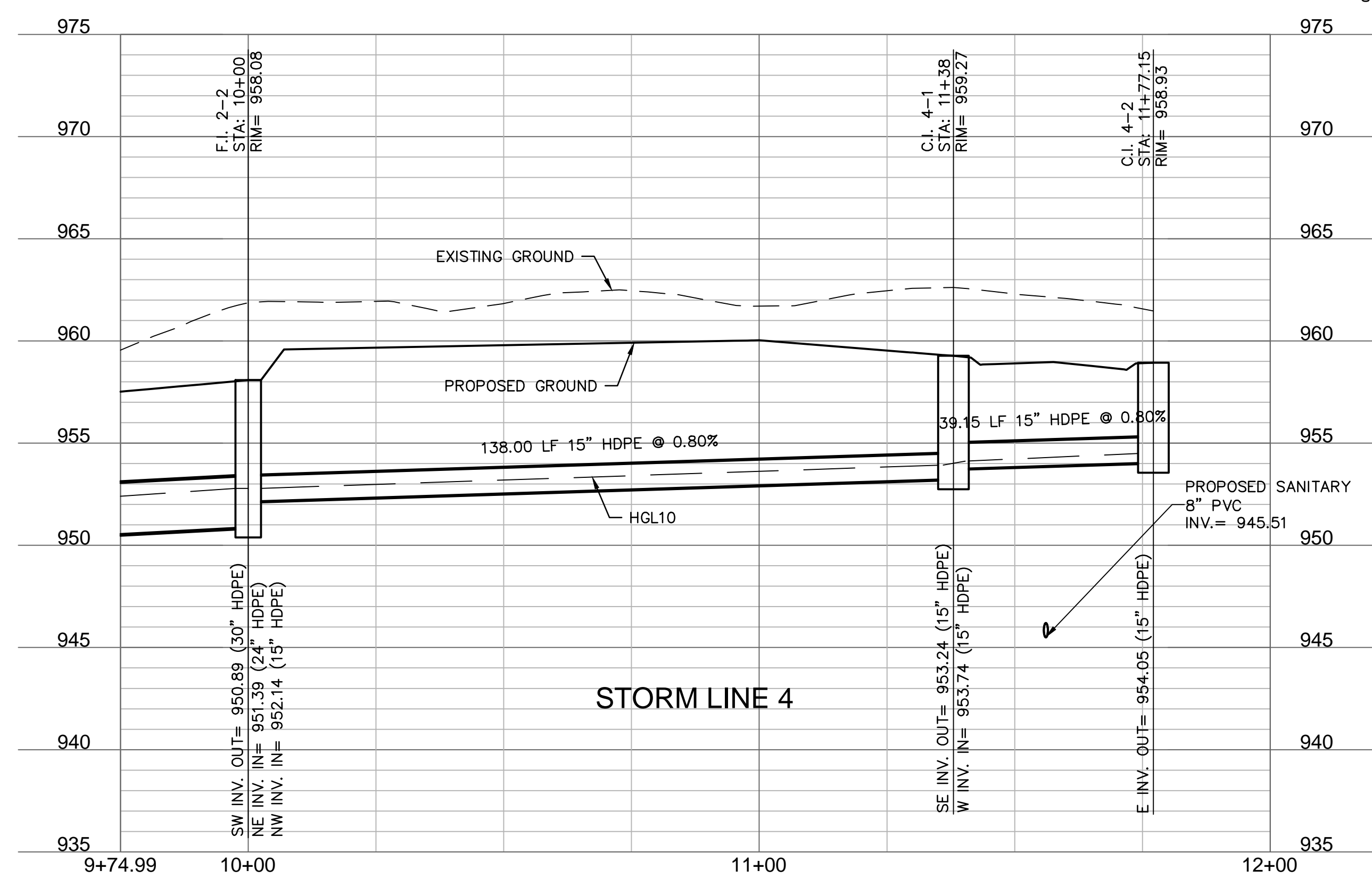
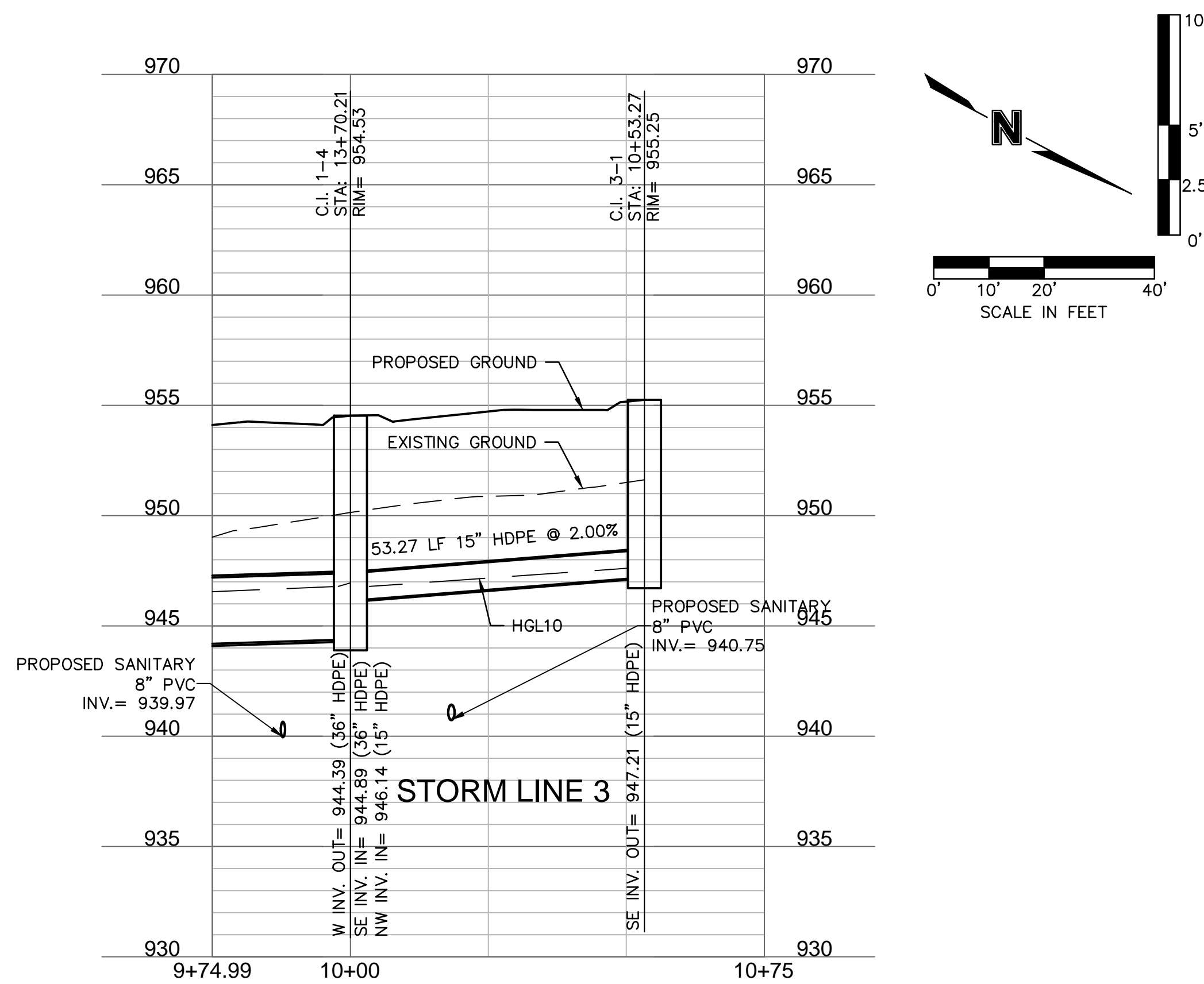
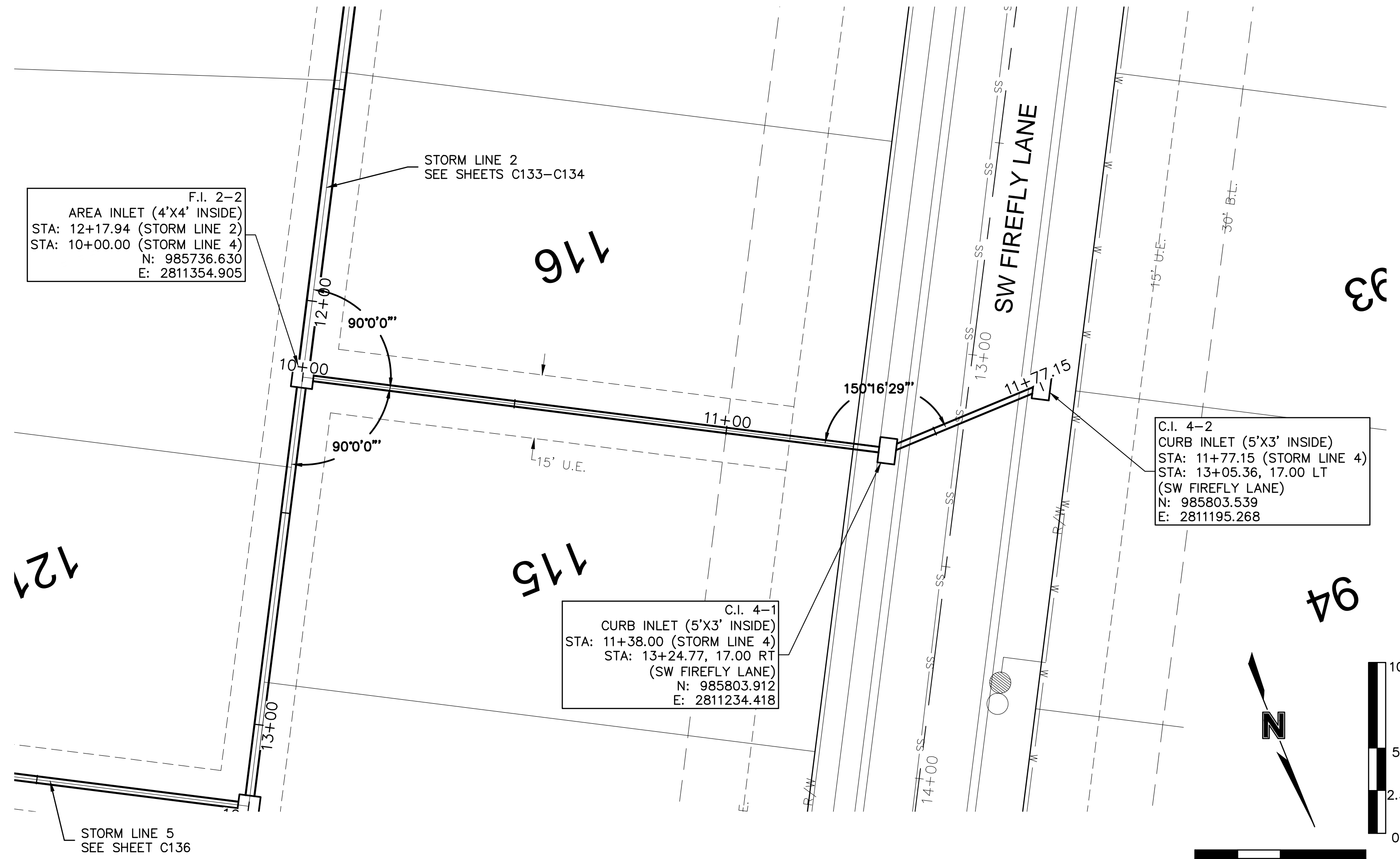
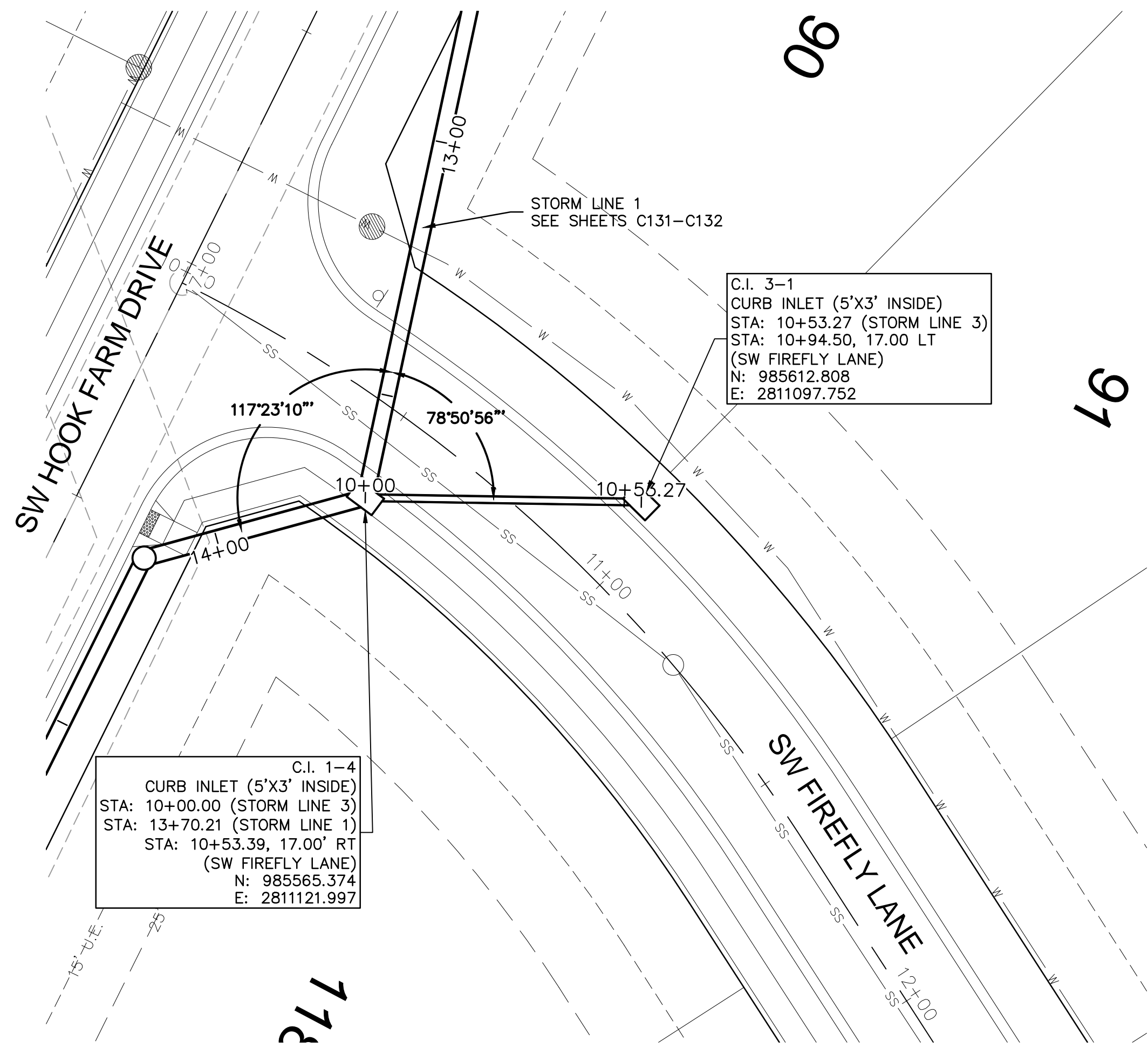

olsson

Olsson - Civil Engineering
 Missouri Certificate of Authority #001592
 1301 Burlington Street
 North Kansas City, MO 64116
 TEL 816.361.1177
 FAX 816.361.1888
 www.olsson.com

REVISIONS

REV. NO.	DATE	REVISIONS DESCRIPTION	BY

STORM SEWER PLAN & PROFILE (LINES 3 & 4)
HOOK FARMS STREET & STORM SEWER PLANS
SECOND PLAT

LEE'S SUMMIT, MO

2021

drawn by: B.M.W./A.A.
 checked by: B.M.W.
 designed by: B.M.W./A.A.
 QA/QC by: J.E.S.
 project no.: B19-4061
 date: 01-08-2021

SHEET C135

DWG: F:\2019\4001-4500\019-4061-b\40-design\AutoCAD\final plans\Storm Plans\C_STM02_B194061.dwg
 DATE: Jan 12, 2021 11:14am XREFS: C_XBASE_B194061 C_PBASE_B194061 C_PBLK_B194061 C_PSTRM_B194061 C_PUTIL_B194061 C_PVENDY_B194061 USER: abdigaliev

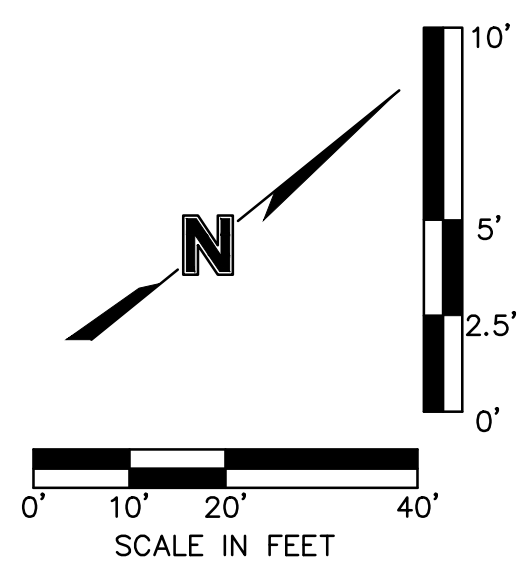
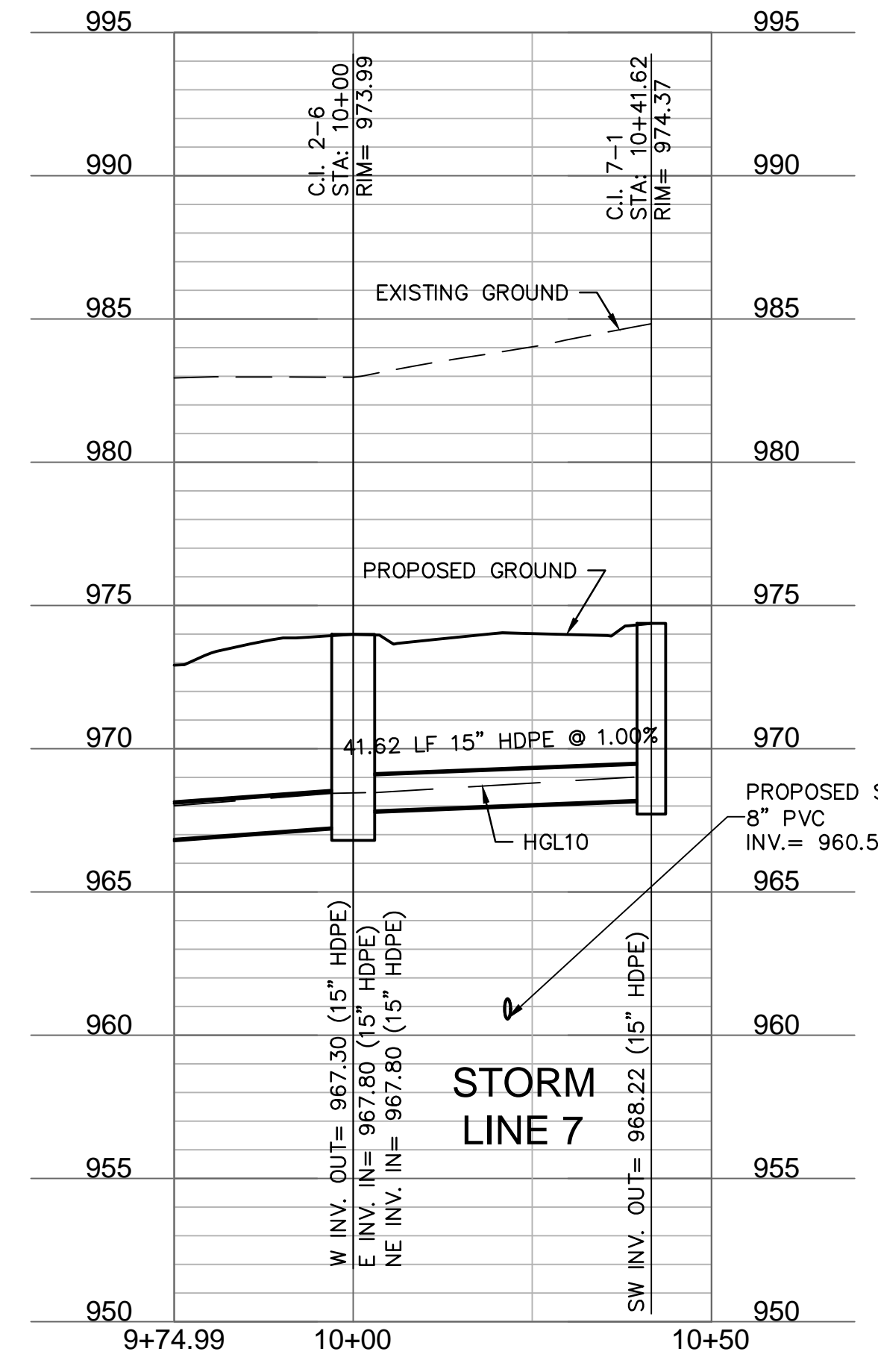
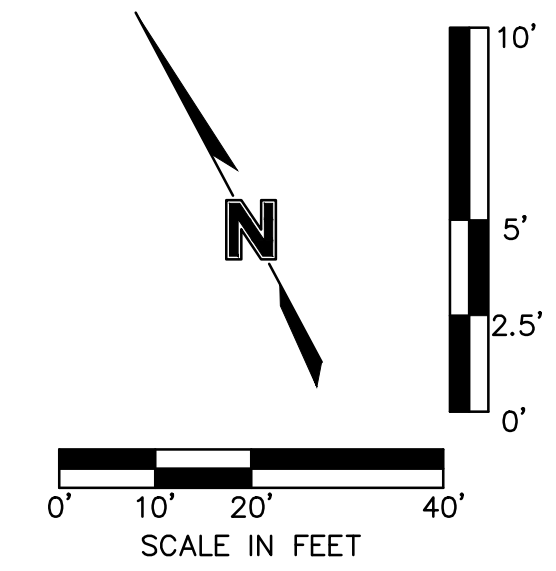
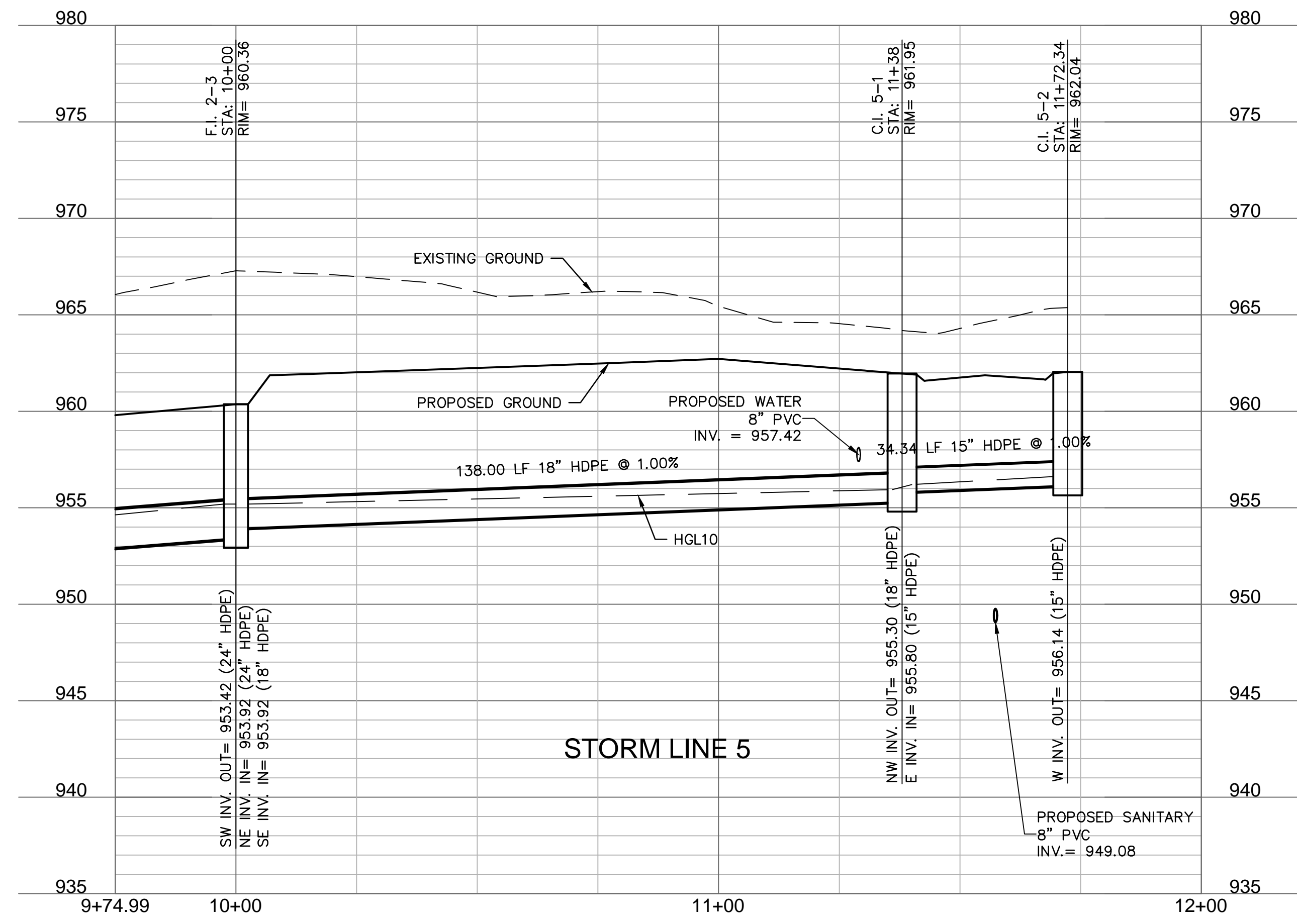
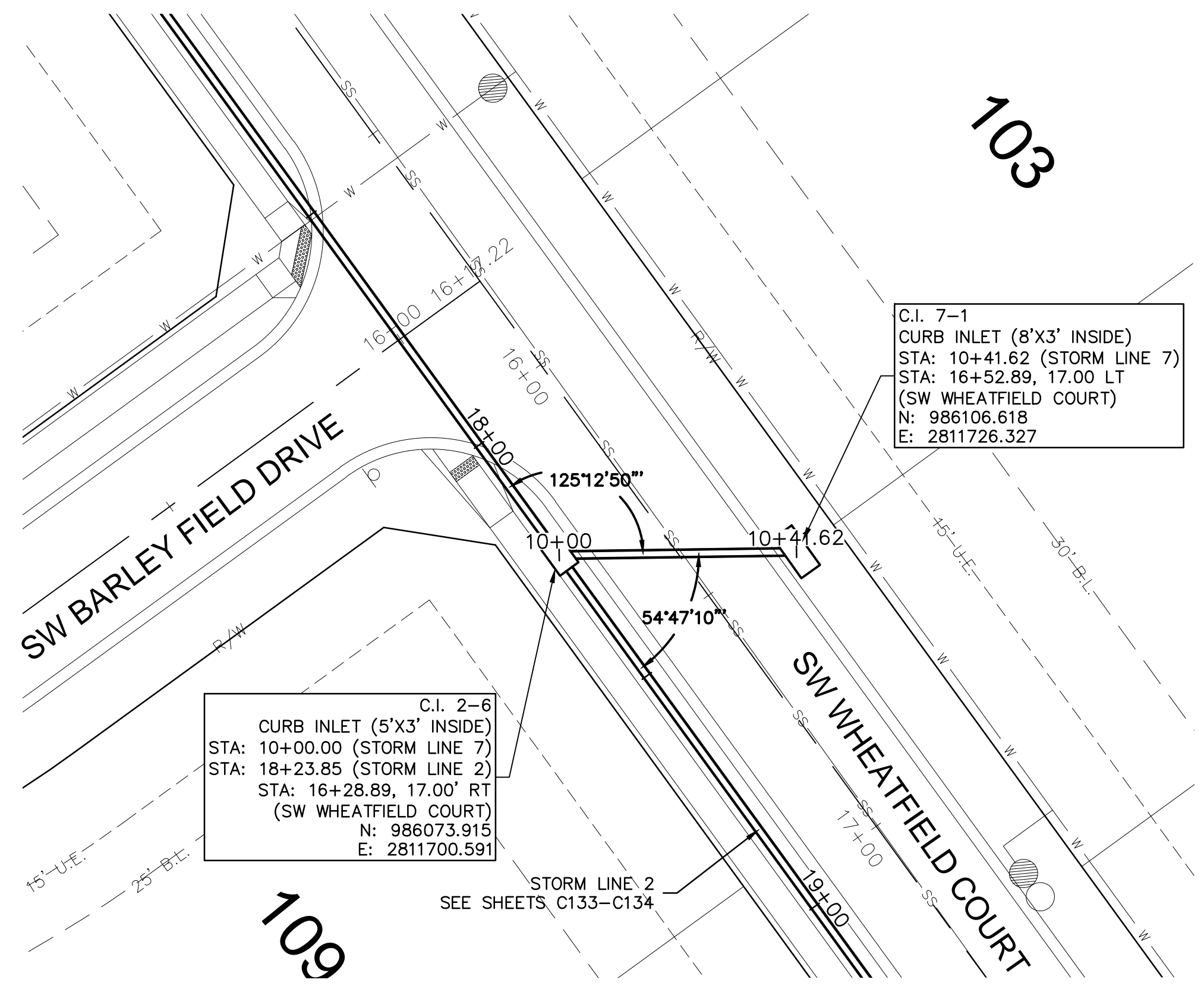
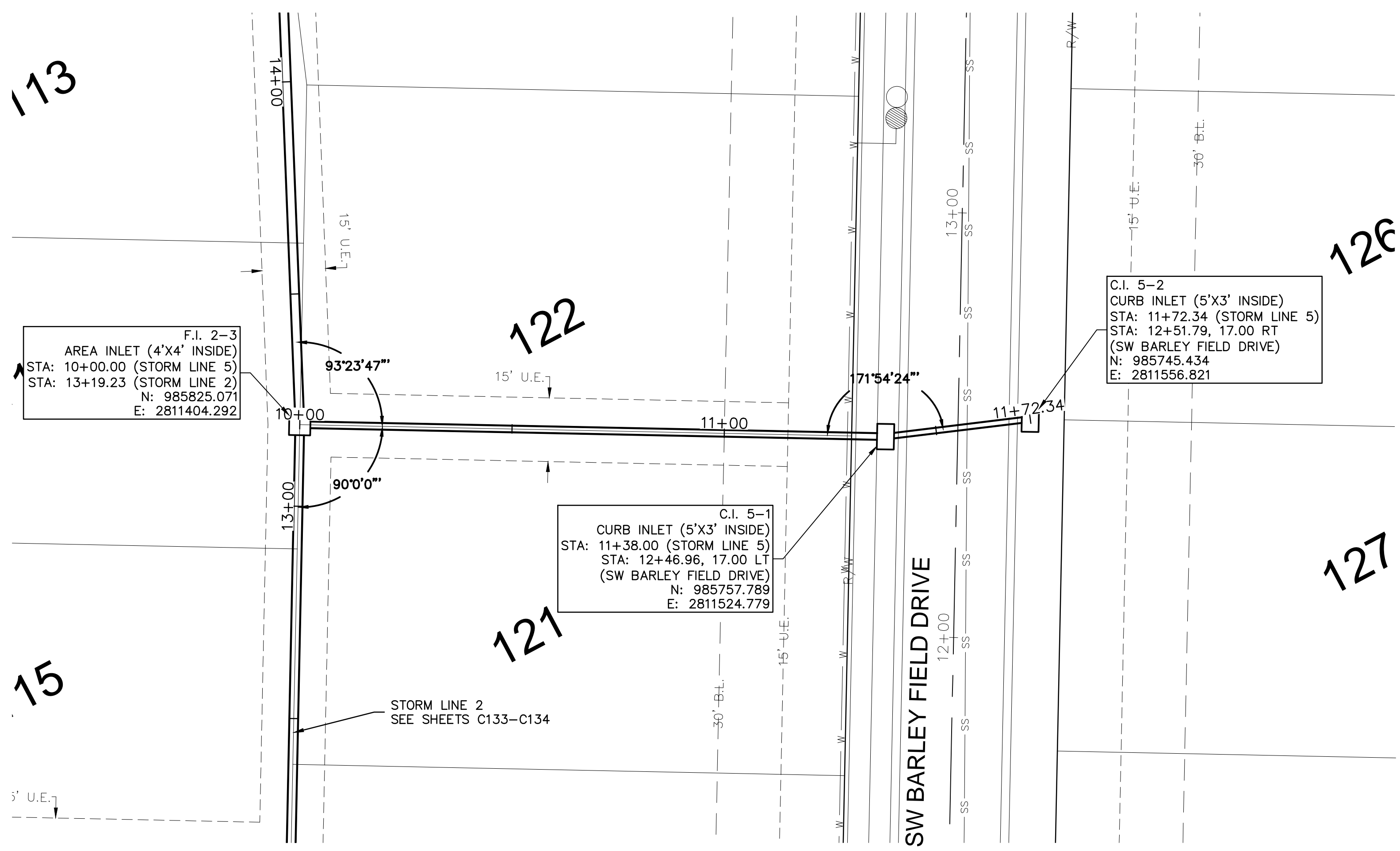

REV. NO.	DATE	REVISIONS DESCRIPTION	BY

STORM SEWER PLAN & PROFILE (LINES 5 & 7)
STREET & STORM SEWER PLANS
 HOOK FARMS
 SECOND PLAT
 LEE'S SUMMIT, MO
 2021

drawn by: B.M.W./A.A.
 checked by: B.M.W.
 designed by: B.M.W./A.A.
 QA/QC by: J.E.S.
 project no.: B19-4061
 date: 01-08-2021

olsson
 Olsson - Civil Engineering
 Missouri Certificate of Authority #001592
 1301 Burlington Street
 North Kansas City, MO 64116
 TEL 816.361.1177
 FAX 816.361.1888
 www.olson.com

DWG: F:\2019\4001-4500\019-4061-b\40-design\AutoCAD\final plans\Storm Plans\C_STM02_B194061.dwg
 DATE: Jan 12, 2021 11:14am
 USER: cabdigaivey
 XREFS: C_XBASE_B194061 C_PBASE_B194061 C_PBLK_B194061 C_PUTIL_B194061 C_PSTRM_B194061

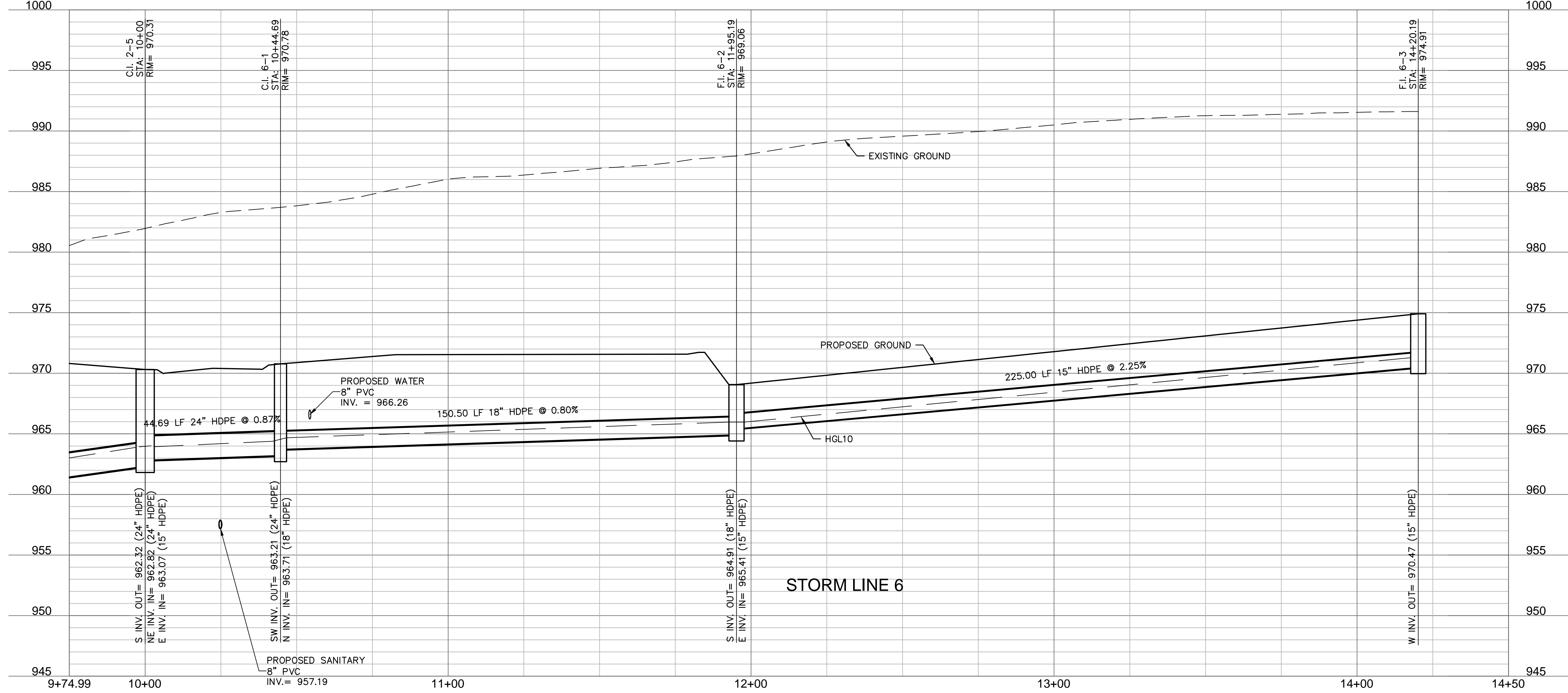
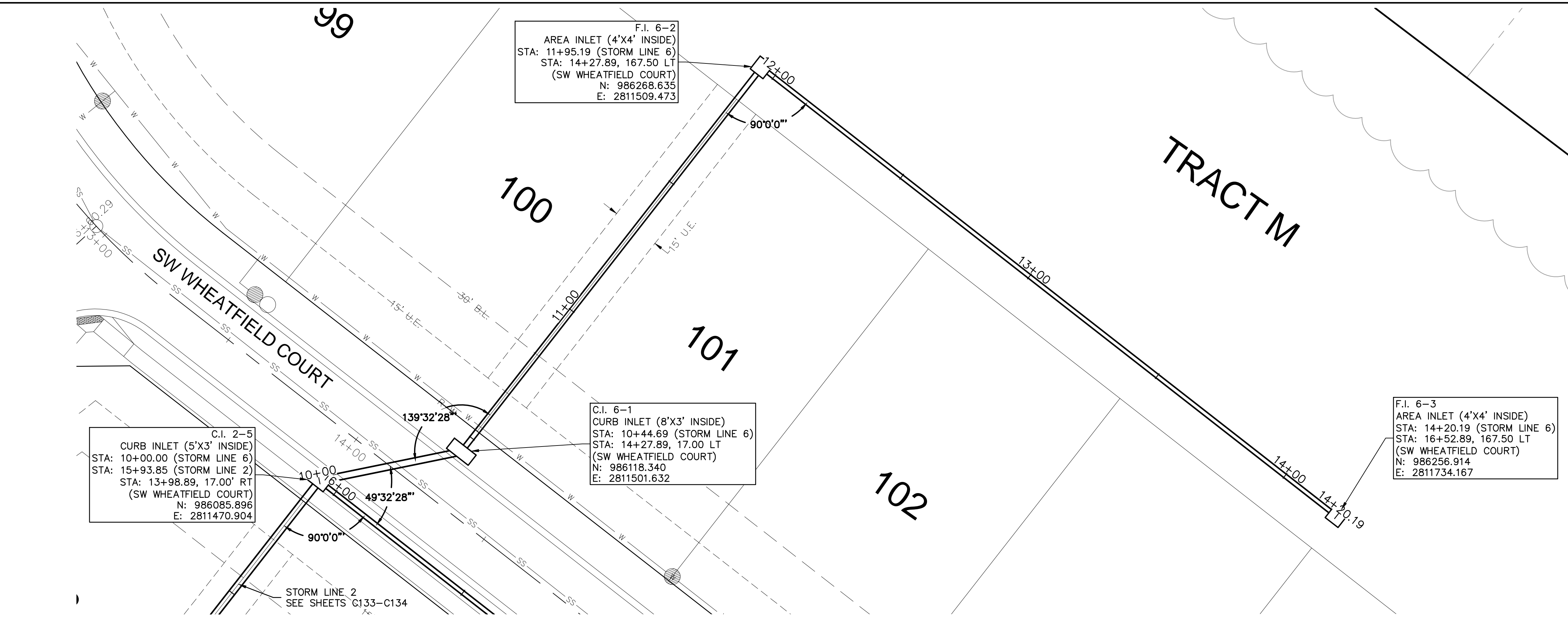

Olsson - Civil Engineering
 Missouri Certificate of Authority #001592
 1301 Burlington Street
 North Kansas City, MO 64116
 TEL 816.361.1177
 FAX 816.361.1888
 www.olsson.com

**STORM SEWER PLAN & PROFILE (LINE 6)
 STREET & STORM SEWER PLANS**

HOOK FARMS
 SECOND PLAT

LEE'S SUMMIT, MO

2021

REV. NO.	DATE	REVISIONS DESCRIPTION	BY

drawn by: B.M.W./A.A.
 checked by: B.M.W.
 designed by: B.M.W./A.A.
 QA/QC by: J.E.S.
 project no.: B19-4061
 date: 01-09-2021

**SHEET
C137**

DWG: F:\2019\4001-4500\019-4061-b\40-design\AutoCAD\final plans\Storm Plans\C_STM02_B194061.dwg
 DATE: Jan 12, 2021 11:14am XREFS: C_XBASE_B194061 C_PBASE_B194061 C_PUTIL_B194061 C_PSTRM_B194061

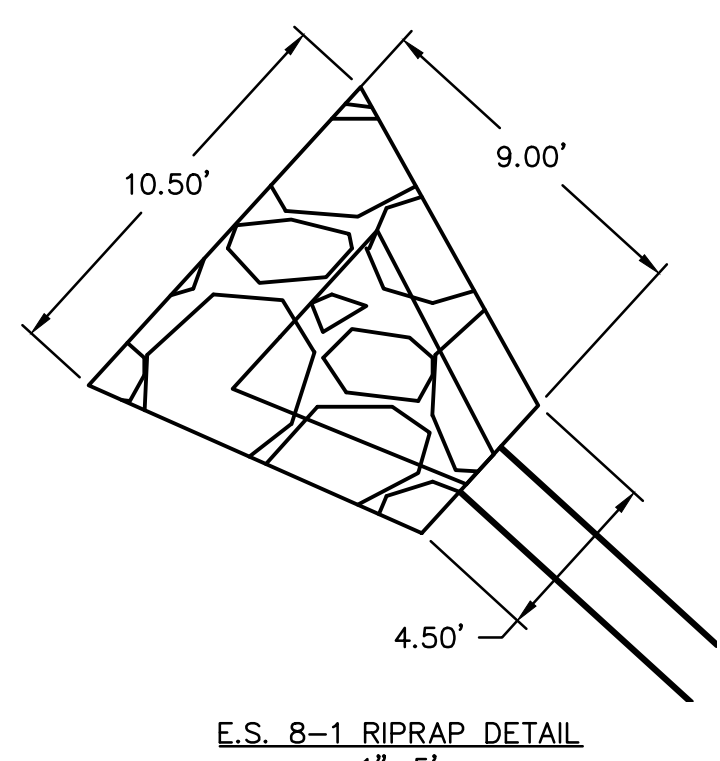
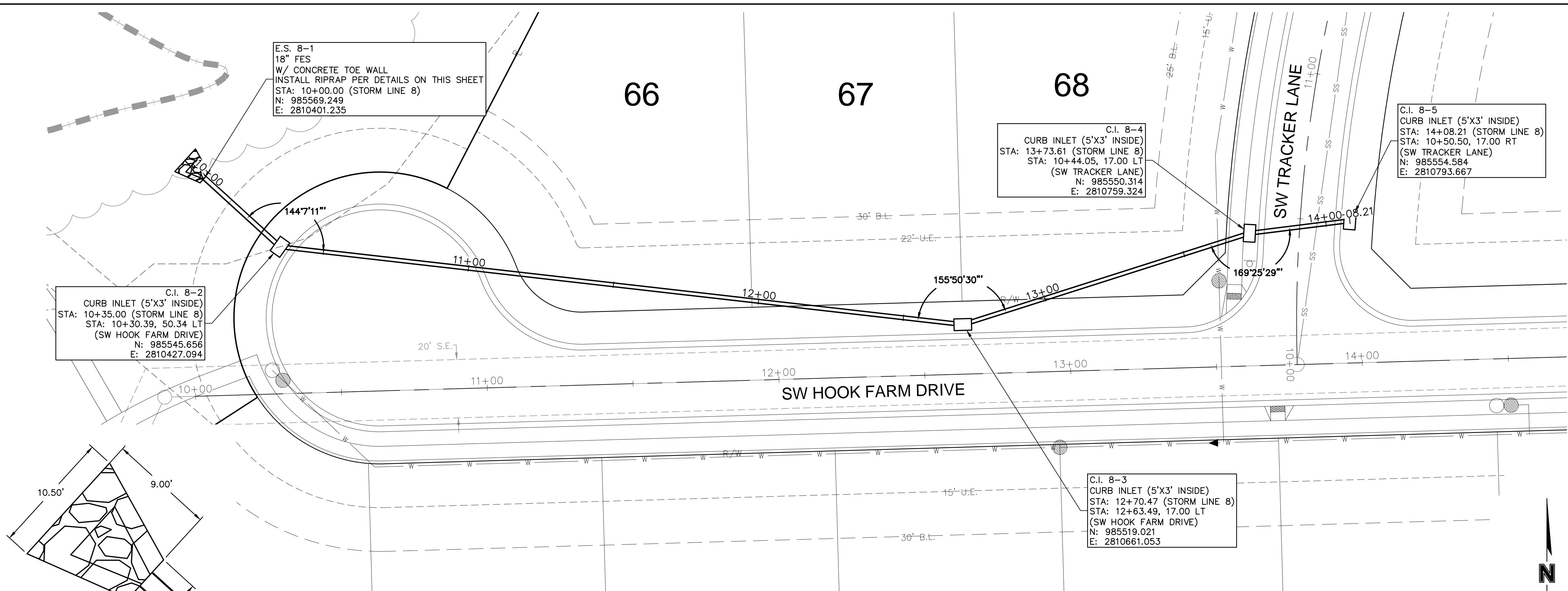

Riprap Calculations							
End Section	Q ₁₀₀ (cfs)	Pipe Diameter (ft)	Class*	D50* (in)	Apron Length (ft)	Apron Depth (ft)	Area (Sq)
E.S. 8-1	17.4	1.5	4	14	9	2.57	7.5

*Per Table 10.1 HEC 14-FHWA-Energy Dissipators Pg. 10-18

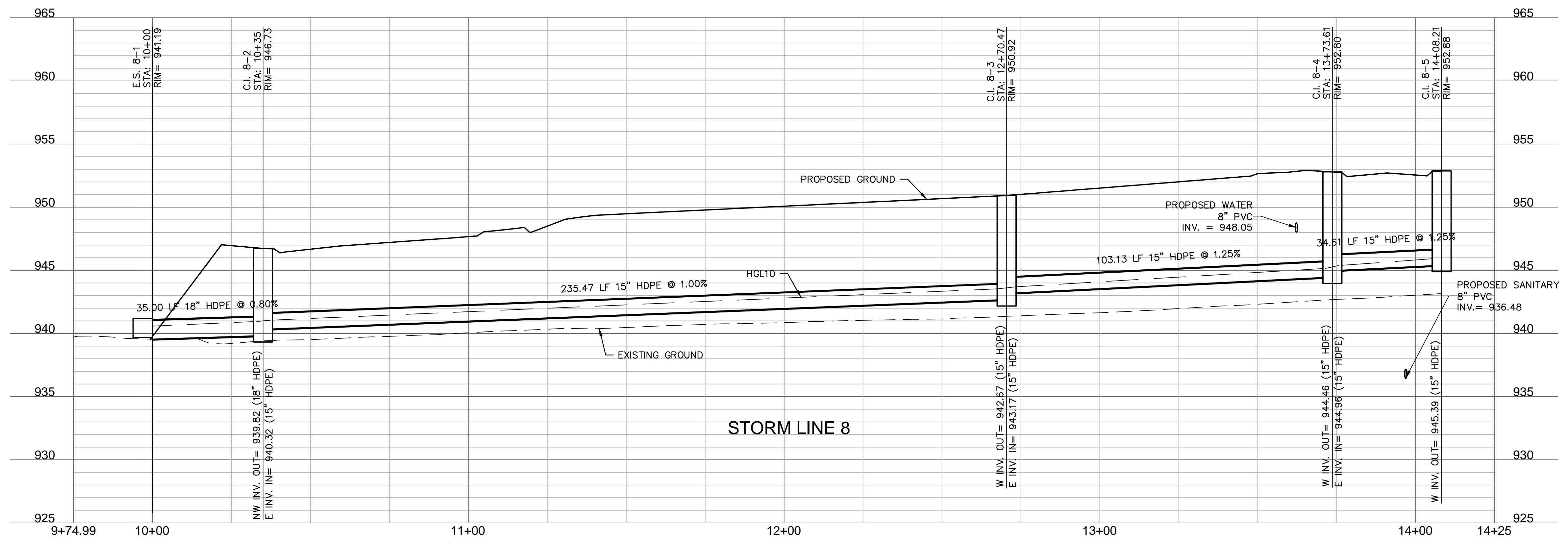
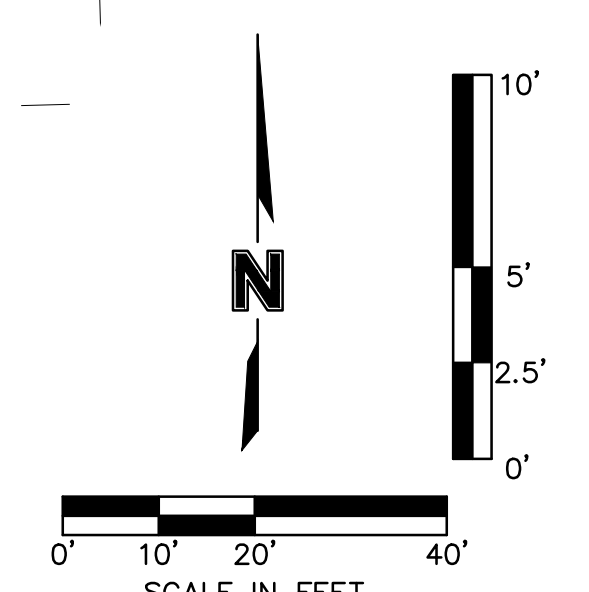

Olsson - Civil Engineering
 Missouri Certificate of Authority #001592
 1301 Burlington Street
 North Kansas City, MO 64116
 TEL 816.361.1177
 FAX 816.361.1888
 www.olson.com

REVISIONS

REV. NO.	DATE	REVISIONS DESCRIPTION	BY

STORM SEWER PLAN & PROFILE (LINE 8)
 STREET & STORM SEWER PLANS

HOOK FARMS
 SECOND PLAT
 2021

drawn by: B.M.W./A.A.
 checked by: B.M.W.
 designed by: B.M.W./A.A.
 QA/QC by: J.E.S.
 project no.: B19-4061
 date: 01-08-2021

LEE'S SUMMIT, MO

SHEET
C138

DWG: F:\2019\4001-4500\019-4061-b\40-design\AutoCAD\final plans\Storm Plans\C_STM03_B194061.dwg
 DATE: Jan 12, 2021 11:15am XREFS: C_XBASE_B194061 C_FBASE_B194061 C_PBASE_B194061 C_PENDY_B194061 C_PTBLK_B194061 C_PSTRM_B194061
 USER: abdigaliyev

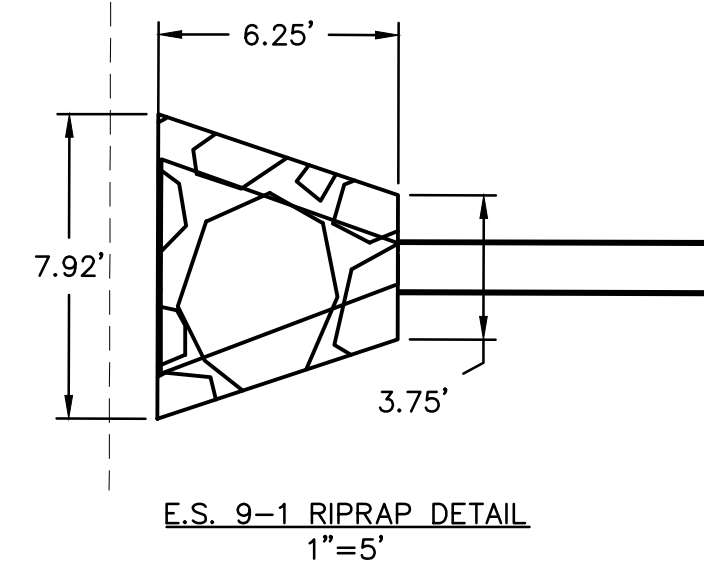

E.S. 9-1
 15" FES
 W/ CONCRETE TOE WALL
 INSTALL RIPRAP PER DETAILS ON THIS SHEET
 STA: 10+00.00 (STORM LINE 9)
 STA: 12+73.74, 179.45 LT
 (SW TRACKER LANE)
 N: 985855.338
 E: 2810683.077

C.I. 9-2
 CURB INLET (5'X3' INSIDE)
 STA: 11+62.45 (STORM LINE 9)
 STA: 12+73.56, 17.00 LT
 (SW TRACKER LANE)
 N: 985776.154
 E: 2810824.917

C.I. 9-3
 CURB INLET (5'X3' INSIDE)
 STA: 12+26.66 (STORM LINE 9)
 STA: 13+28.01, 17.00 RT
 (SW TRACKER LANE)
 N: 985807.139
 E: 2810881.161

F.I. 9-4
 AREA INLET (4'X4' INSIDE)
 STA: 13+64.66 (STORM LINE 9)
 STA: 13+28.01, 155.00 RT
 (SW TRACKER LANE)
 N: 985739.857
 E: 2811001.648

End Section	Q ₁₀₀ (cfs)	Pipe Diameter (ft)	Class*	D50* (in)	Apron Length (ft)	Apron Depth (ft)	Area (SY)
E.S. 9-1	11.2	1.25	3	10	22.12	2.00	20.2

*Per Table 10.1 HEC-14 FHWA-Energy Dissipators Pg. 10-18

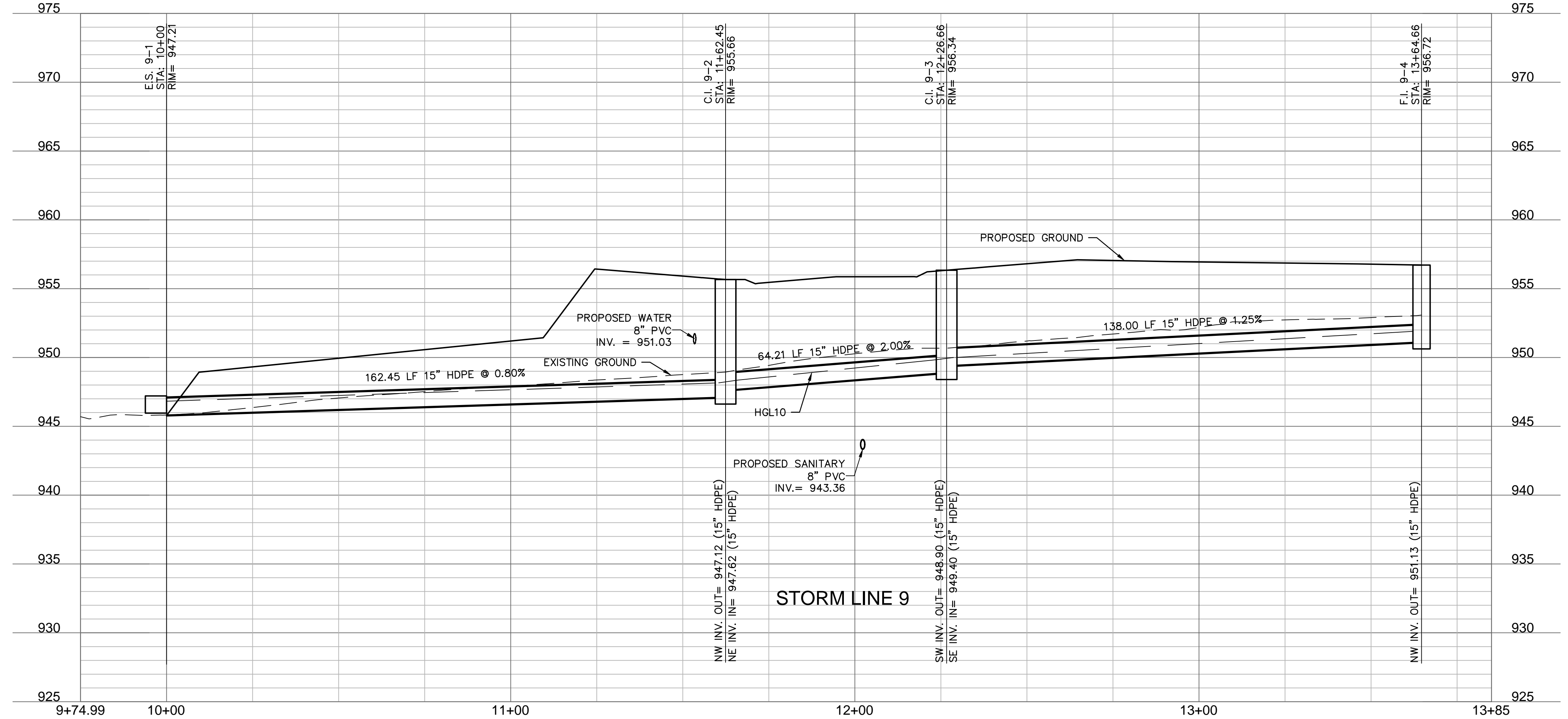

Olsson - Civil Engineering
 Missouri Certificate of Authority #001592
 1301 Burlington Street
 North Kansas City, MO 64116
 TEL 816.361.1177
 FAX 816.361.1888
 www.olsson.com

REVISIONS

REV. NO.	DATE	REVISIONS DESCRIPTION	BY

STORM SEWER PLAN & PROFILE (LINE 9)
STREET & STORM SEWER PLANS

HOOK FARMS
 SECOND PLAT

LEE'S SUMMIT, MO

2021

drawn by: B.M.W./A.A.
 checked by: B.M.W.
 designed by: B.M.W./A.A.
 QA/QC by: J.E.S.
 project no.: B19-4061
 date: 01-09-2021

SHEET
C139

DWG: F:\2019\4001-4500\019-4061-b\40-design\AutoCAD\final plans\Storm Plans\C_STM03_B194061.dwg
 DATE: Jan 12, 2021 11:15am XREFS: C_XBASE_B194061 C_PBASE_B194061 C_PENDY_B194061 C_PUTIL_B194061 C_PSTRM_B194061
 USER: abdigaliev

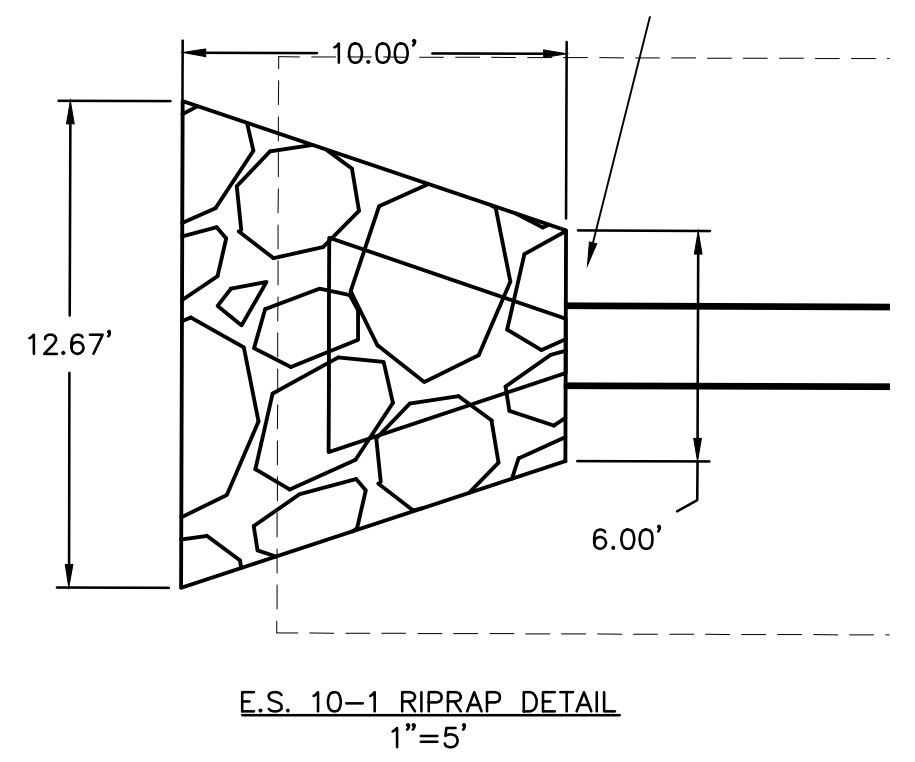

End Section	Q ₁₀₀ (cfs)	Pipe Diameter (ft)	Class*	D50* (in)	Apron Length (ft)	Apron Depth (ft)	Area (SY)
E.S. 10-1	21.85	2	3	10	10	2.00	10.4

* Per Table 10.1 HEC 14-FHWA-Energy Dissipators Pg. 10-18

E.S. 10-1
 24" FES
 W/ CONCRETE TOE WALL
 INSTALL RIPRAP PER DETAILS ON THIS SHEET
 STA: 10+00.00 (STORM LINE 10)
 STA: 14+92.52, 182.97 LT
 (SW TRACKER LANE)
 N: 986048.268
 E: 2810786.780

C.I. 10-2
 CURB INLET (5'X3' INSIDE)
 STA: 11+65.97 (STORM LINE 10)
 STA: 14+92.52, 17.00 LT
 (SW TRACKER LANE)
 N: 985967.351
 E: 2810931.684

C.I. 10-3
 CURB INLET (5'X3' INSIDE)
 STA: 12+35.35 (STORM LINE 10)
 STA: 10+00.00 (STORM LINE 11)
 STA: 15+53.01, 17.00' RT
 (SW TRACKER LANE)
 N: 986003.585
 E: 2810990.860

F.I. 10-4
 AREA INLET (4'X4' INSIDE)
 STA: 13+73.35 (STORM LINE 10)
 STA: 15+53.01, 155.00 RT
 (SW TRACKER LANE)
 N: 985936.303
 E: 2811111.347

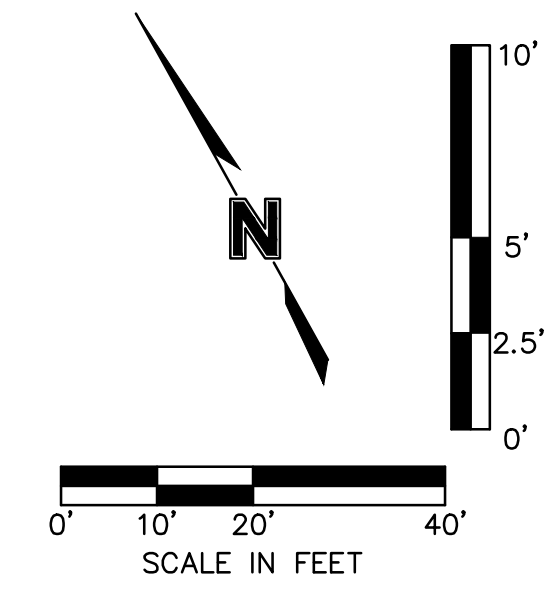
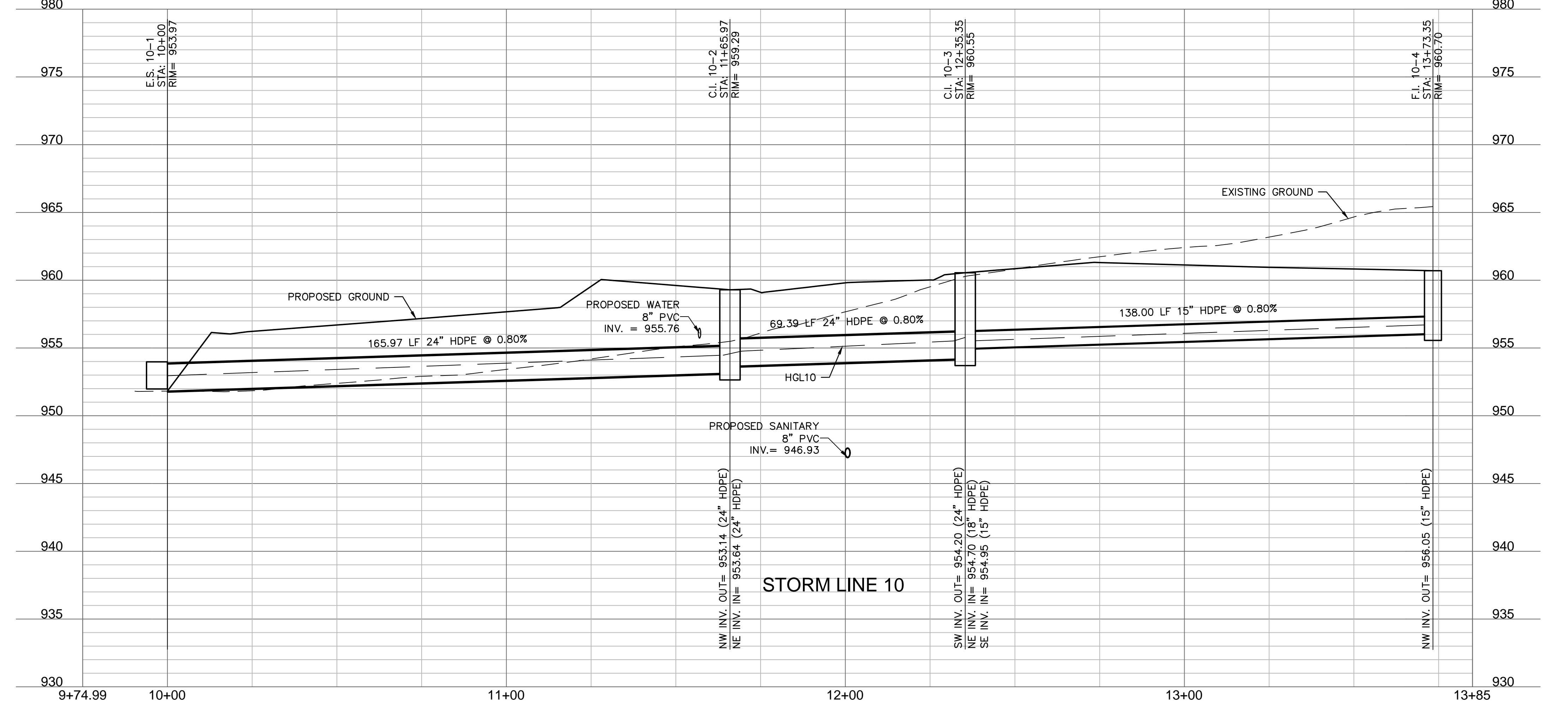
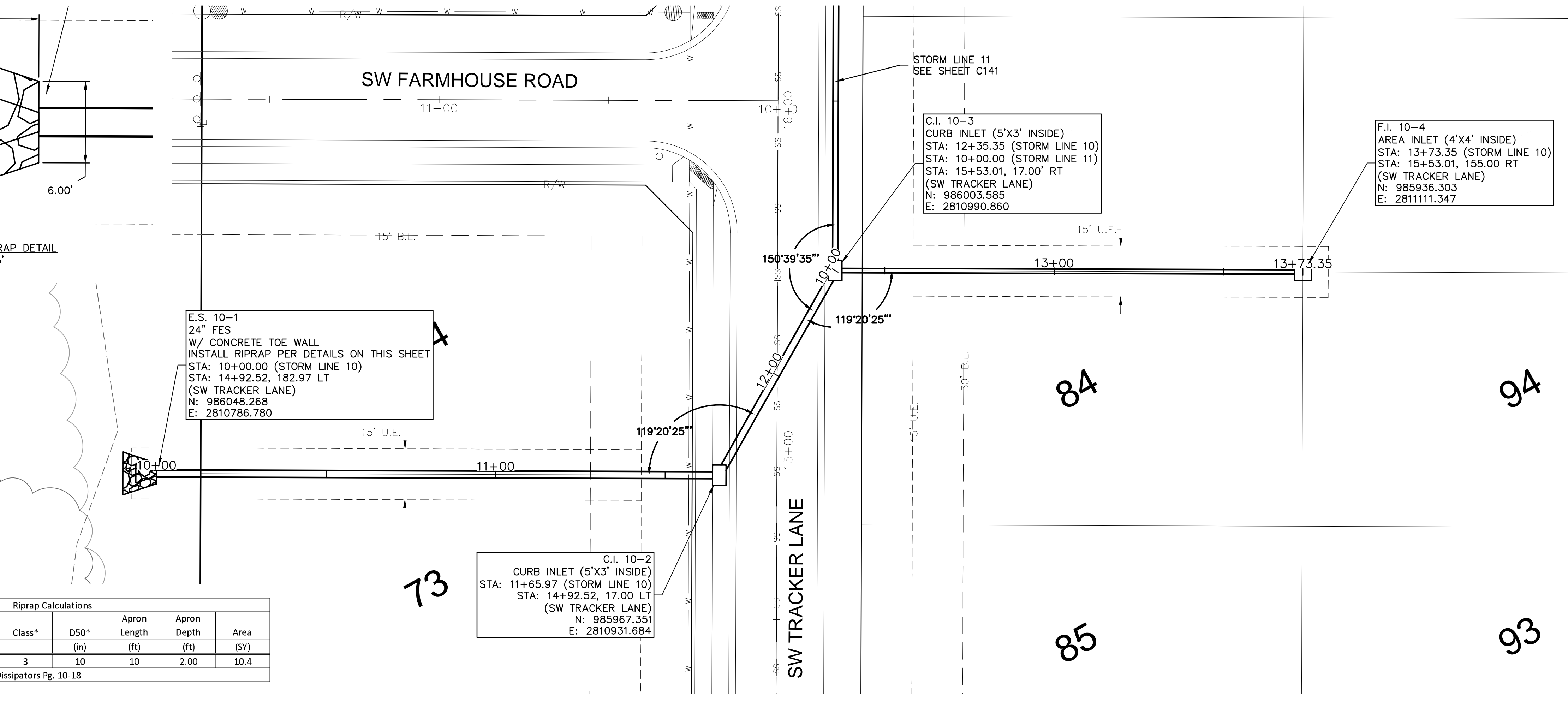

olsson

Olsson - Civil Engineering
 Missouri Certificate of Authority #001592
 1301 Burlington Street
 North Kansas City, MO 64116
 TEL 816.361.1177
 FAX 816.361.1888
 www.olson.com

REVISIONS

REV. NO.	DATE	REVISIONS DESCRIPTION	BY

STORM SEWER PLAN & PROFILE (LINE 10)
 STREET & STORM SEWER PLANS

2021

HOOK FARMS
 SECOND PLAT

LEE'S SUMMIT, MO

drawn by: B.M.W./A.A.
 checked by: B.M.W.
 designed by: B.M.W./A.A.
 QA/QC by: J.E.S.
 project no.: B19-4061
 date: 01-08-2021

**SHEET
 C140**

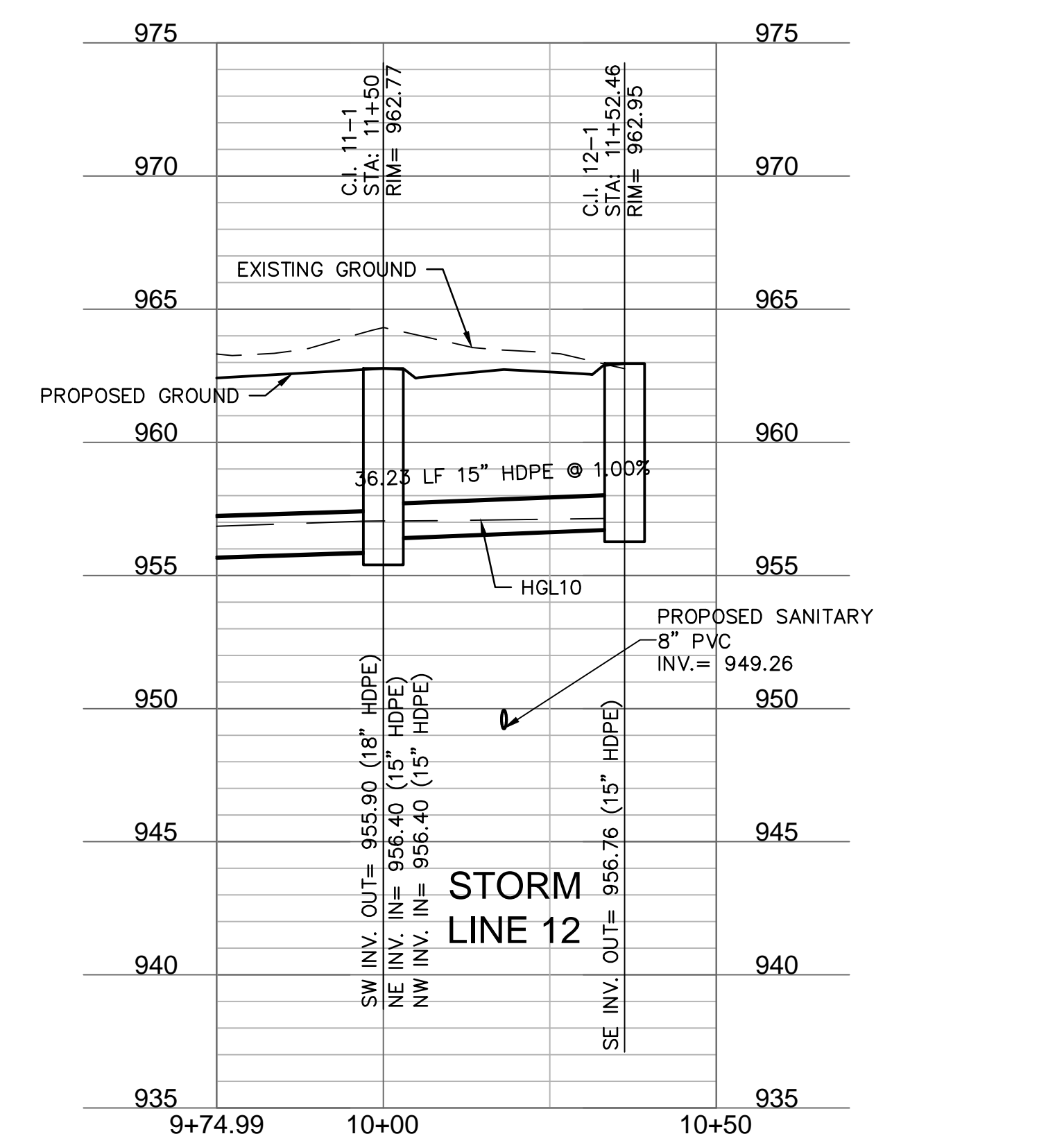
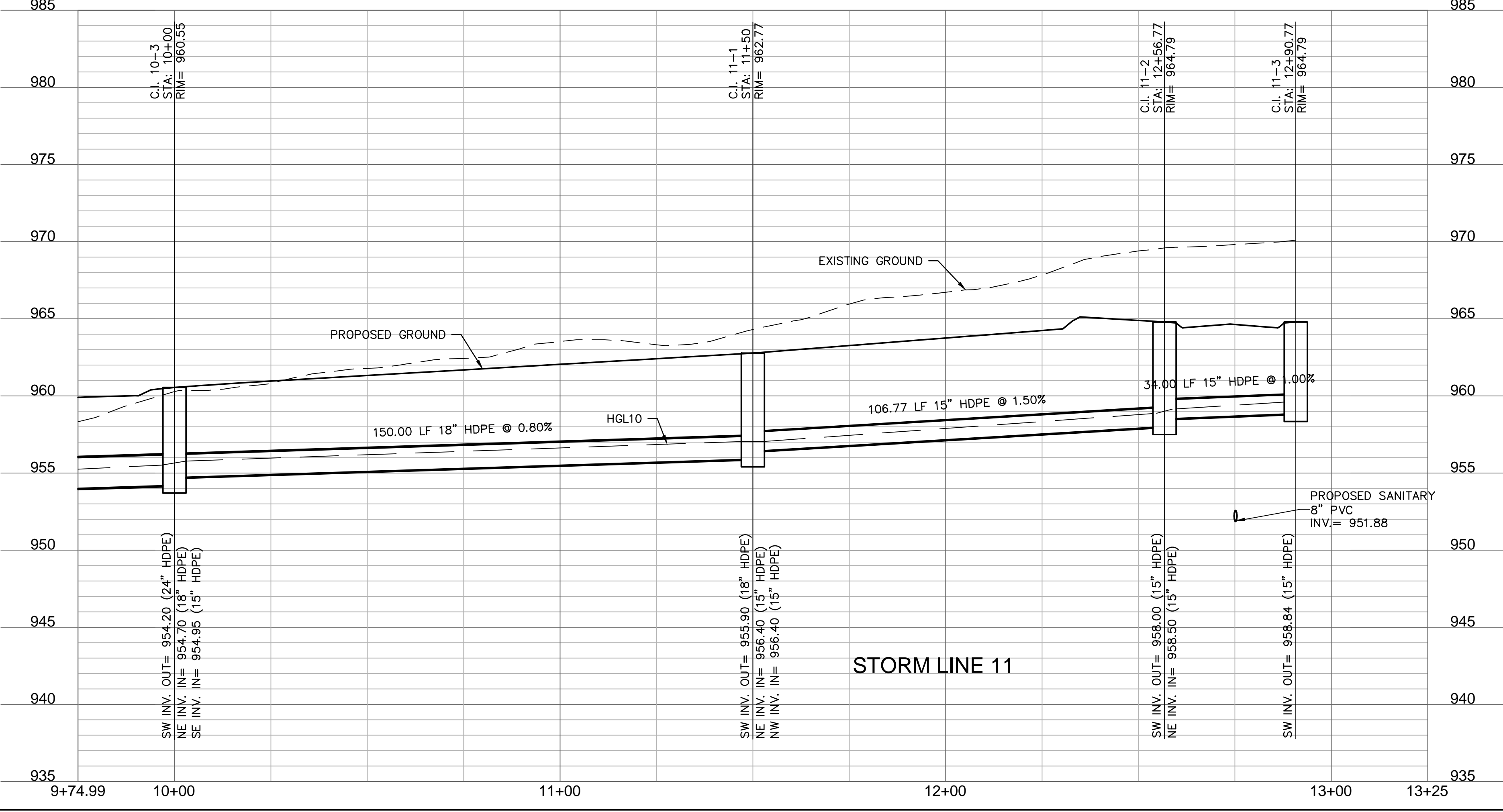
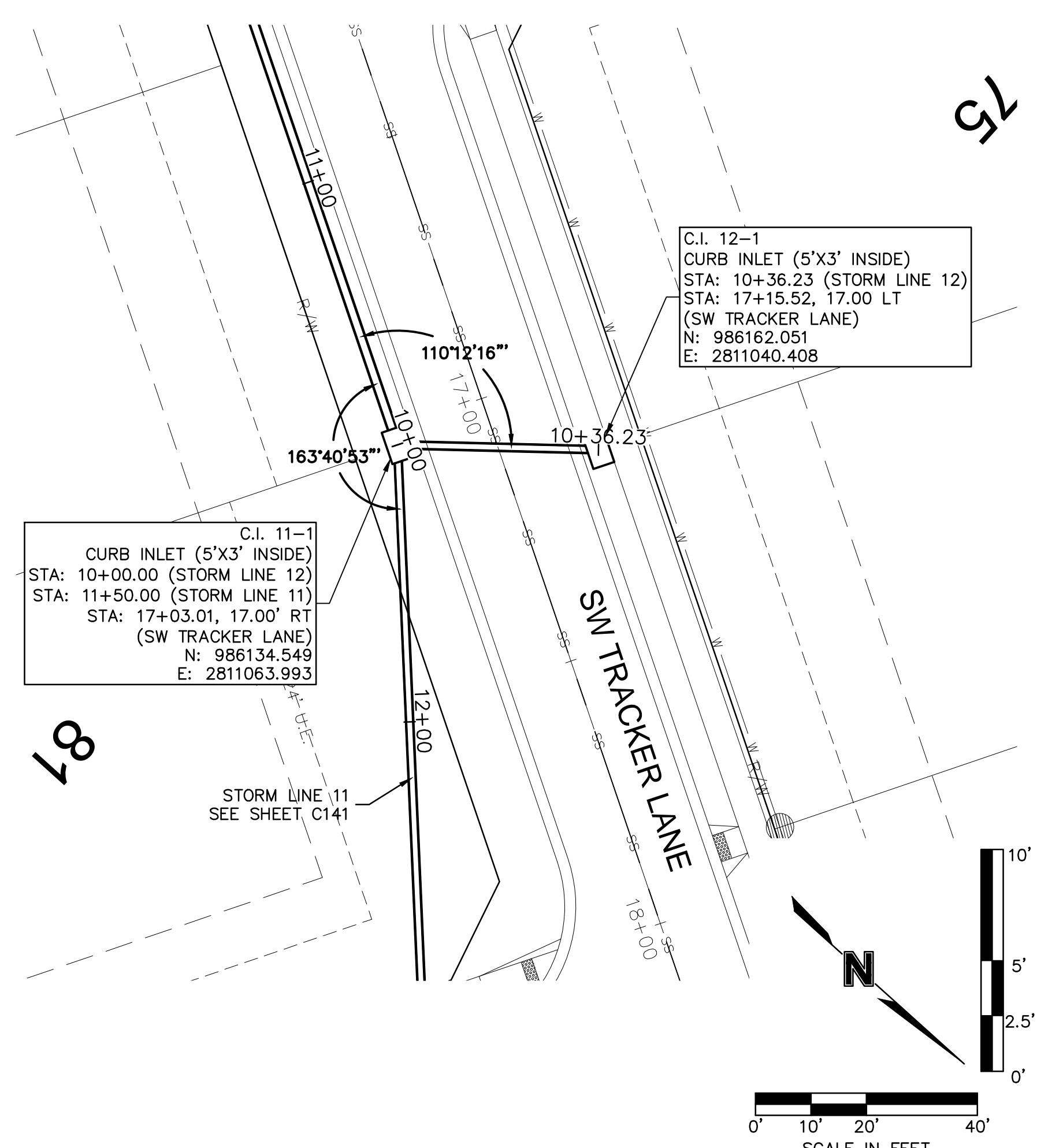
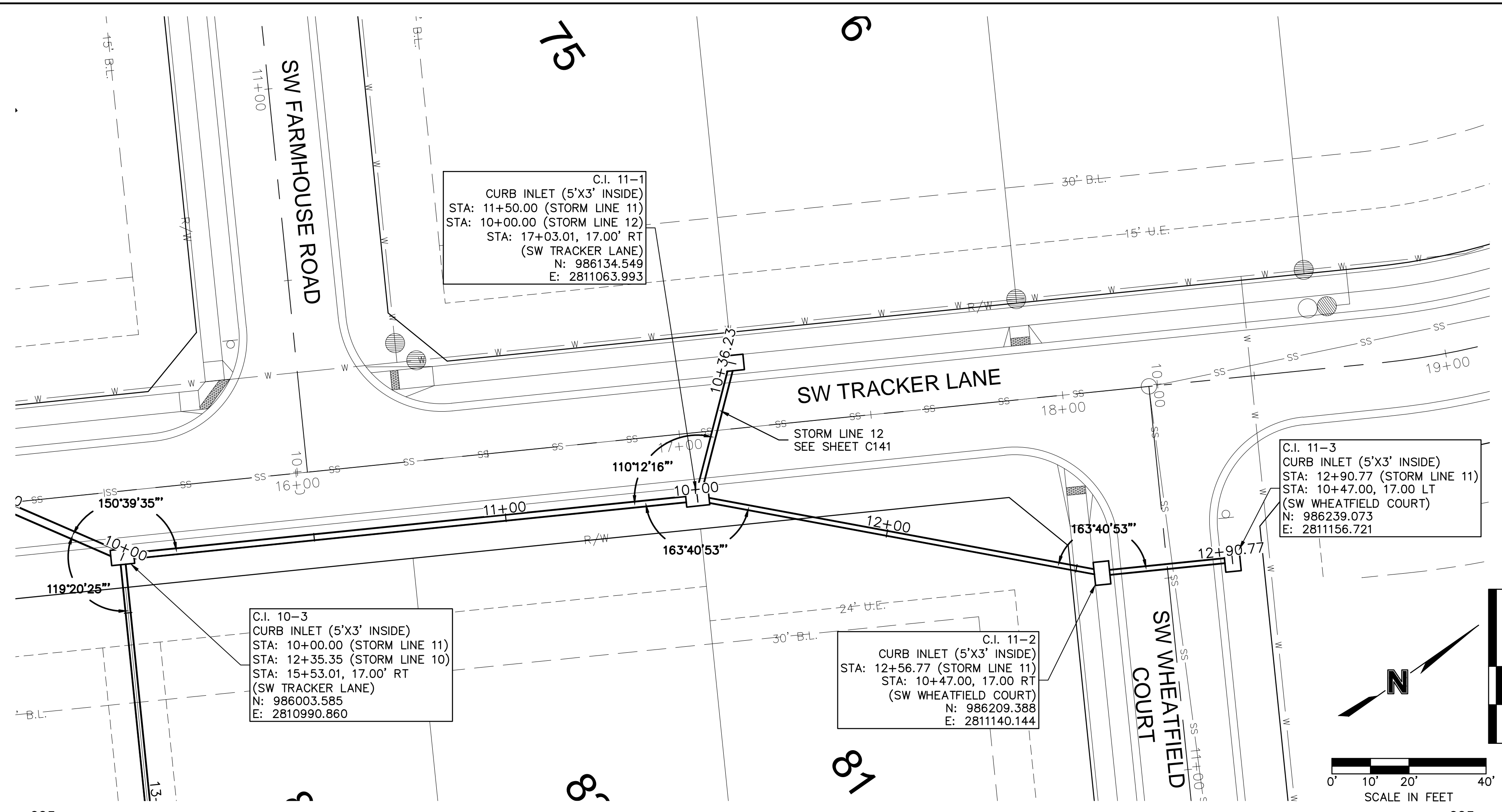

olsson

Olsson - Civil Engineering
Missouri Certificate of Authority #001592
1301 Burlington Street
North Kansas City, MO 64116
TEL 816.361.1177
FAX 816.361.1888
www.olson.com

REV. NO.	DATE	REVISIONS DESCRIPTION	BY

STORM SEWER PLAN & PROFILE (LINES 11 & 12)
STREET & STORM SEWER PLANS
HOOK FARMS
SECOND PLAT

LEE'S SUMMIT, MO

drawn by:	B.M.W./A.A.
checked by:	B.M.W.
designed by:	B.M.W./A.A.
QA/QC by:	J.E.S.
project no.:	B19-4061
date:	01-09-2021

REVISIONS
2021

SHEET C141

DWG: F:\2019\4001-4500\019-4061-b\40-design\AutoCAD\final plans\Sheets\GNCV\Street & Storm Plans\C_DRN02_B194061.dwg
 DATE: Jan 12, 2021 11:17am XREFS: C:\BASE_B194061 C:\BASE_B194061 C:\FBNDY_B194061 C:\PUTIL_B194061 C:\PTBLK_B194061 C:\PSTRM_B194061

LEGEND	
	FINISHED INDEX CONTOURS
	FINISHED INTERMEDIATE CONTOURS
	RIDGE LINE
	DRAINAGE AREA
	RUNOFF COEFFICIENT
	STORM STRUCTURE NUMBER

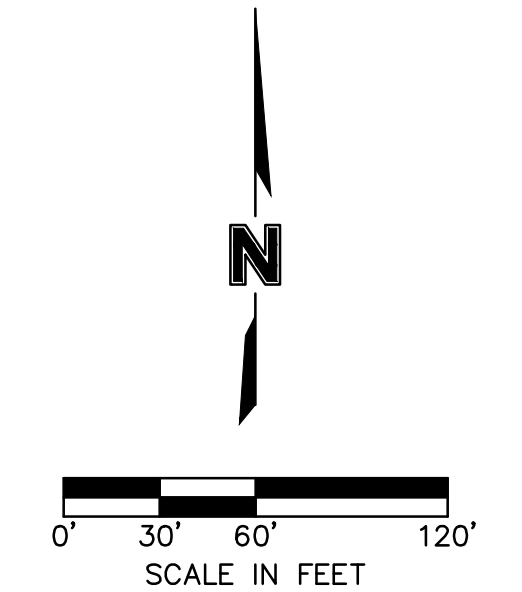

Olsson - Civil Engineering
 Missouri Certificate of Authority #001592
 1301 Burlington Street
 North Kansas City, MO 64116
 TEL 816.361.1177
 FAX 816.361.1888
 www.olsson.com

REV. NO.	DATE	REVISIONS DESCRIPTION	BY

DRAINAGE PLAN
STREET & STORM SEWER PLANS

HOOK FARMS
SECOND PLAT

LEE'S SUMMIT, MO

2021

drawn by: B.M.W./A.A.
 checked by: B.M.W.
 designed by: B.M.W./A.A.
 QA/QC by: J.E.S.
 project no.: B19-4061
 date: 01-08-2021

SHEET
C144

APPENDIX C

Hook Farms Preliminary Stormwater Drainage Study

HOOK FARMS PRELIMINARY STORMWATER DRAINAGE STUDY

Prepared for:

Hunt Midwest Real Estate Development, Inc.
8300 NE Underground Drive
Kansas City, Missouri 64161



**March 2019
Olsson Project No. 018-1853**

olsson

TABLE OF CONTENTS

1.0	General Information	1
1.1	FEMA Floodplain Classification	2
1.2	Soil Classifications	2
2.0	Methodology	2
3.0	Existing Conditions	3
4.0	Proposed Conditions	6
4.1	Detention Analysis.....	7
4.2	Free Release Analysis.....	8
4.3	Extended Detention.....	9
4.4	Impacts to Stream Buffer.....	10
5.0	Summary	10
6.0	Conclusions and Recommendations.....	10

LIST OF TABLES

Table 1.	Soil Classifications.	2
Table 2.	Precipitation Depths.	3
Table 3.	Curve Numbers.	4
Table 4.	Existing Conditions Subarea Data.	5
Table 5.	Existing Conditions Point of Interest Peak Flow Rates.	5
Table 6.	Existing Conditions Point of Interest Onsite Area.	5
Table 7.	Proposed Conditions Subarea Data.	6
Table 8.	Detention Analysis Flow and Volume Data.....	7
Table 9.	Detention Analysis Point of Interest Peak Flow Rates.	7
Table 10.	Detention Analysis vs. Existing Conditions.	8
Table 11.	Free Release Analysis Point of Interest Peak Flow Rates.	8
Table 12.	Free Release Analysis vs. Existing Conditions.....	8
Table 13.	Free Release Analysis vs. Detention Analysis.....	9

LIST OF FIGURES

Figure 1.	Location Map	1
-----------	--------------------	---

APPENDICES

Appendix A: Site Maps

Appendix B: Existing Conditions TR-55 Inputs and Results

Appendix C: Existing Conditions HEC-HMS Model Inputs and Results

Appendix D: Proposed Conditions TR-55 Inputs and Results

Appendix E: Detention Analysis HEC-HMS Model Inputs & Results

Appendix F: Free Release Analysis HEC-HMS Model Inputs & Results

Appendix G: Waiver Request

Appendix H: Extended Detention Calculations

1.0 GENERAL INFORMATION

Hook Farms is a proposed 258-lot single-family residential development on approximately 160 acres. The project is located at the northwest corner of Hook Road and Pryor Road, and is adjacent to the Eagle Creek and Monarch View developments. The project lies in the southeast corner of Section 23, Township 47 North, Range 32 West, Lee's Summit, Jackson County, Missouri.

Stormwater from Hook Farms is conveyed into the Mouse Creek Watershed primarily via Mouse Creek (which flows east to west through the property), Mouse Creek Tributary M5 (which flows south to north through the property), and Mouse Creek Tributary M4 (which flows through the northwest corner of the property).

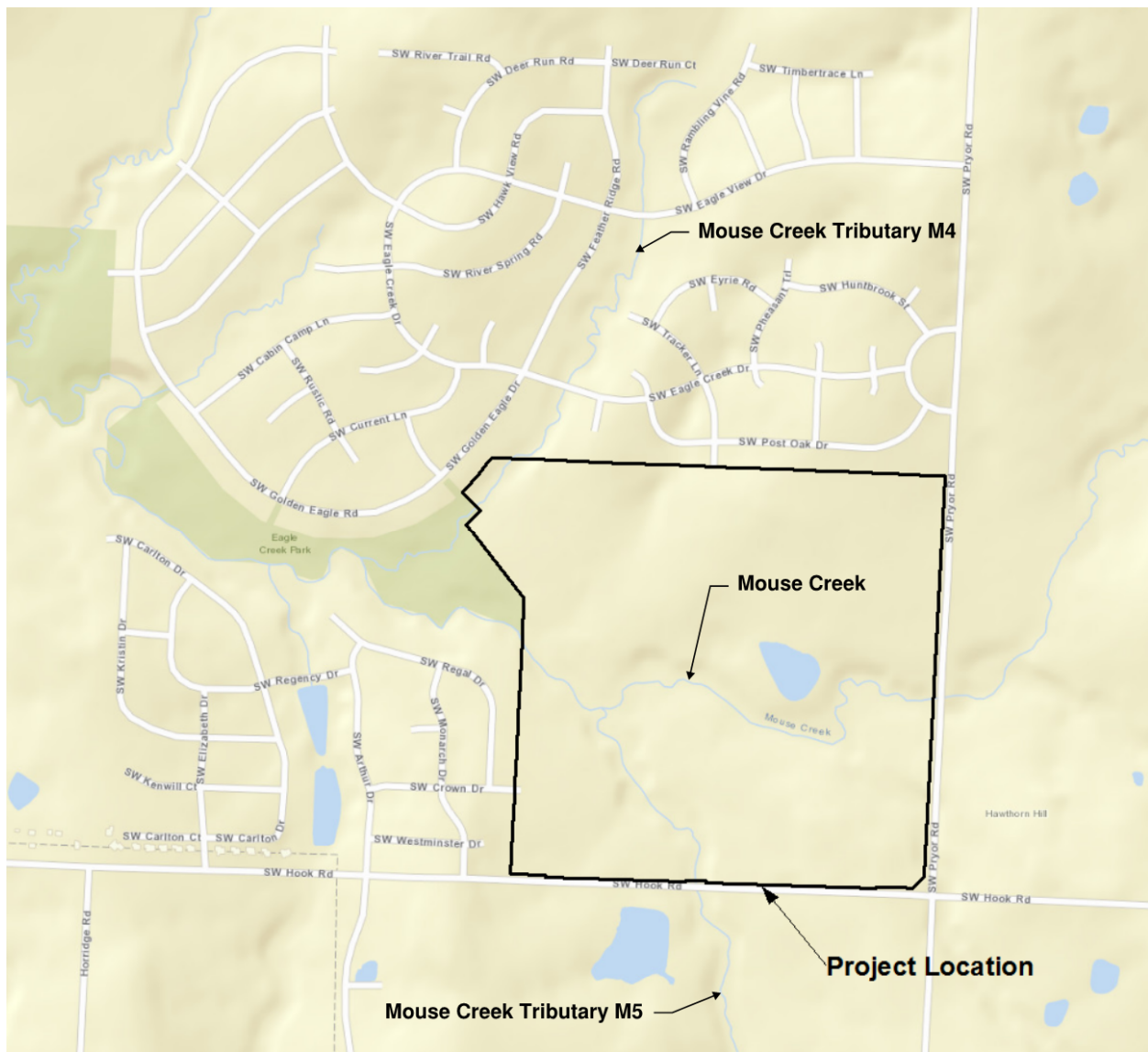

Figure 1. Location Map

1.1 FEMA Floodplain Classification

The Federal Emergency Management Agency (FEMA) Flood Boundary and Floodway Map Community Panel Number 29095C0531G classifies portions of the Hook Farms property as “Zone AE” and portions as unshaded “Zone X” area. See Exhibit 1 in Appendix A for the location of the site in relation to FEMA flood boundaries.

1.2 Soil Classifications

Soil maps published by the Natural Resources Conservation Service (NRCS) Web Soil Survey were used to categorize soils on the Hook Farms property (see Table 1). Exhibit 2 in Appendix A shows a map of soils on the property.

Table 1. Soil Classifications.

Symbol	Name	Slopes	HSG
10000	Arisburg silt loam	1-5%	C
10024	Greenton-Urban land complex	5-9%	D
10082	Arisburg-Urban land complex	1-5%	C
10116	Sampsel silty clay loam	2-5%	C / D
10117	Sampsel silty clay loam	5-9%	C / D
10128	Sharpsburg-Urban land complex	2-5%	D
10180	Udarents-Urban land-Sampsel complex	2-5%	C
10181	Udarents-Urban land-Sampsel complex	5-9%	C
36083	Kennebec silt loam	1-4%	C

*HSG = Hydrologic Soil Group

2.0 METHODOLOGY

This drainage study has been prepared to evaluate the hydrologic impact generated by development of Hook Farms. The base data for the models has been obtained from available online maps and aerial imagery. Stormwater quantity management is based upon methods and objectives defined in the “Kansas City Metropolitan Chapter American Public Works Association (KC-APWA) Section 5600 Storm Drainage Systems & Facilities” (2011).

The following methods were used in this study to model existing and proposed conditions for stormwater runoff:

United States Army Corps of Engineers Hydraulic Engineering Center Hydraulic Modeling System (HEC-HMS) Version 4.3

- Loss Method: SCS Curve Number
- Transform Method: SCS Unit Hydrograph

- 2-year, 10-year and 100-year Return Frequency Storms
- 24-Hour SCS Type II Rainfall Distribution

United States Department of Agriculture WinTR-55 Small Watershed Hydrology

- SCS TR-55 methods for determination of Time of Concentration and Travel Time. Where specific data pertaining to channel geometry is not available, “Length & Velocity” estimates for channel flow Travel Time is used per Section 5600, KC-APWA Standard Specifications and Design Criteria.

Stormwater runoff models were created for the 2-, 10-, and 100-year design storm events. The precipitation depths used in the analysis have been interpolated from the “Technical Paper No. 40 Rainfall Frequency Atlas of the United States” (TP-40) isopluvial maps (May 1961). Table 2 summarizes the rainfall depths used in this analysis:

Table 2. Precipitation Depths.

Return Period (year)	24-Hour Precipitation Depth (inches)
2	3.60
10	5.34
100	7.90

3.0 EXISTING CONDITIONS

To quantify the effects of development of this project, the following areas and points of interest have been used for existing and proposed conditions analysis. See Exhibit 3 in Appendix A, Existing Conditions Drainage Area Map.

Watershed A discharges to Mouse Creek. The total area modeled within this watershed is approximately 1,808 acres, of which 8.4 percent is within the Hook Farms overall property boundary and therefore considered “on-site.”

The majority of Watershed A is off-site and located upstream of the property. **Point 1** is a point approximately 1,460 feet downstream of the property boundary, where Mouse Creek converges with Mouse Creek Tributary M4 and includes all on-site and off-site drainage areas. **Point 2** is a point approximately 2,210 feet upstream of Point 1 and is a convergence point where discharge from subareas A6, A5, and A4 via Mouse Creek and discharge from subareas A3 and A2 via Mouse Creek Tributary M5 converge.

Runoff from **Subarea A5** enters the property from the east via Mouse Creek through an existing box culvert located under Southwest Pryor Road. Runoff from **Subarea A6** enters the property from the southeast via an unnamed tributary and runs through an existing box culvert located under Southwest Hook Road and Southwest Pryor Road. Runoff from **Subarea A3** enters the property from the south via Mouse Creek Tributary M5 that flows under an existing bridge at Southwest Hook Road. The entirety of these three subareas are considered off-site and remain

unchanged in the proposed conditions analysis. Drainage area, curve numbers, and time of concentration for Watershed A can be seen in Table 4.

Watershed B discharges to the southwest via Mouse Creek Tributary M4. The total area modeled within this watershed is approximately 368 acres, about 2 percent of which is within the Hook Farms overall property boundary and considered “on-site.” Where development occurs along the ridgeline between Watershed B and Watershed A, approximately 1.5 acres is expected to be redirected to the south from Watershed B to Watershed A. Drainage area, curve numbers and time of concentration for Watershed B can be seen in Table 4.

To provide a direct comparison between the existing and proposed conditions models, the points of interest have been kept consistent throughout the analysis.

Tables 3, 4, 5, and 6 summarize the results of the existing conditions analysis. The proposed conditions data will be compared to these results in Section 4 of this report. Refer to Appendix B for existing conditions TR-55 results. Refer to Appendix C for output and a schematic of the existing conditions HEC-HMS model.

Curve numbers were determined based on the soil classifications outlined in Section 1.2 and existing land use. Land use was determined from Geographic Information System (GIS) information provided by the City and updated per recent aerial imagery. Curve numbers were assumed as shown in Table 3.

Table 3. Curve Numbers.

Land Use	HSG	CN
Single-Family Residential	C	83
Multifamily Residential	C	90
Public / Semi-Public Use	C	86
Road / Right-of-Way	C	90
Undeveloped	C	74
Agricultural	C	79
Commercial	C	94
Single-Family Residential	D	87
Multifamily Residential	D	92
Public / Semi-Public Use	D	89
Road / Right-of-Way	D	92
Undeveloped	D	80
Agricultural	D	84
Commercial	D	95

*HSG = Hydrologic Soil Group, *CN = Curve Number

Table 4. Existing Conditions Subarea Data.

Subarea	Onsite Area (acres)	Offsite Area (acres)	Total Area (acres)	T _c (hour)	Weighted CN
A1	31.01	55.18	86.19	0.346	82
A2	35.13	3.68	38.81	0.270	80
A3	0.00	592.18	592.18	0.765	80
A4	86.02	28.20	114.22	0.399	80
A5	0.00	857.89	857.89	0.781	80
A6	0.00	118.35	118.35	0.446	79
Total A	152.16	1,655.48	1,807.64		
B1	8.58	358.99	367.57	0.623	81
Total B	8.58	358.99	367.57		

*T_c = Time of Concentration, *CN = Curve Number

Table 5. Existing Conditions Point of Interest Peak Flow Rates.

Point of Interest	Q ₂ (cfs)	Q ₁₀ (cfs)	Q ₁₀₀ (cfs)
Point 1	2,222	4,259	7,229
Point 2	1,810	3,474	5,878

*Q = Flow Rate, *cfs = cubic feet per second

Table 6. Existing Conditions Point of Interest Onsite Area.

Point of Interest	Total Area (acres)	Onsite Area (acres)	Percent Onsite
Point 1	2,175.21	160.74	7.4%
Point 2	1,721.45	121.15	7.0%

Mouse Creek and Mouse Creek Tributary M5 fall within the requirements of KC-APWA Section 5605.3 Stream Preservation and Buffers Zones. This approach to designating the stream buffer width includes defining the Ordinary High-Water Mark (OHM) and defining a width of preservation zone from the OHM on either side of the channel. The OHM for each channel was roughly defined using GIS contours and aerial data.

Mouse Creek and Mouse Creek Tributary M5 flow through the site and are located within Watershed A. Mouse Creek flows into the site on the eastern property boundary with approximately 858 acres of contributing area. Mouse Creek Tributary M5 enters the site on the southern property boundary with approximately 592 acres of contributing area. The confluence of Mouse Creek and Mouse Creek Tributary M5 is located on-site at Point 2, with approximately

1,721 acres of total contributing area. Per KC-APWA Table 5605-1, the stream buffer width for both channels is defined as 100 feet measured outwards from the OHM in each direction.

Mouse Creek Tributary M4 is located within Watershed B. The channel flows from northeast to southwest through the northwest corner of the site before the confluence with Mouse Creek at Point 1 and has approximately 368 acres of contributing area. Per KC-APWA Table 5605-1, the stream buffer width is defined as 100 feet measured outwards from the OHM in each direction.

4.0 PROPOSED CONDITIONS

The proposed conditions section of analysis assumes completion of the entire Hook Farms development. A shift of ridgelines within the property boundary because of anticipated grading activities shifts the drainage boundaries between subareas A1, A2, A4, and B1; in addition, subarea A4 has been divided into two subareas (A4-1 and A4-2) and subarea A1 has been divided into three subareas (A1-1, A1-2, and A1-3). The overall drainage area contributing to Point 1 remains 2,175 acres, of which 161 acres is considered on-site. The modeled subareas A3, A5, and A6, and the points of interest remain the same as the existing conditions model. See Exhibit 4 in Appendix A, Proposed Conditions Drainage Area Map. Table 7 contains a summary of the subarea data for proposed conditions. Runoff curve numbers, times of concentration, routings, and tributary regions that are outside the property boundary remain the same as in Section 3. Refer to Appendix D for proposed conditions TR-55 results.

Table 7. Proposed Conditions Subarea Data.

Subarea	Onsite Area (acres)	Offsite Area (acres)	Total Area (acres)	T _c (hour)	Weighted CN
A1-1	0.00	29.22	29.22	0.173	84
A1-2	47.88	0.47	48.35	0.280	84
A1-3	0.00	27.98	27.98	0.197	89
A2	33.22	1.21	34.43	0.241	83
A3	0.00	592.18	592.18	0.765	80
A4-1	71.19	6.11	77.30	0.343	84
A4-2	0.00	22.09	22.09	0.198	85
A5	0.00	857.89	857.89	0.781	80
A6	0.00	118.35	118.35	0.446	79
Total A	152.29	1,655.50	1,807.79		
B1	8.45	358.97	367.42	0.623	81
Total B	8.45	358.97	367.42		

*T_c = Time of Concentration, *CN = Curve Number

4.1 Detention Analysis

The existing conditions HEC-HMS model was updated to reflect the changes outlined in Section 4.0 to analyze the effects of detention for the developed site. Conceptual basins were input into the model for subareas A1-2, A2 and A4-1 and sized based on the extreme flood event control release rates outlined in APWA Section 5608.4 (100-year storm peak rate less than or equal to 3.0 cfs per site acre, 10-year storm peak rate less than or equal to 2.0 cfs per site acre). All three conceptual basins meet the allowable release rates for the 10-year and 100-year events aside from Basin A1-2, which does not meet the allowable release rate for the 10-year event by 2 cfs. Subarea B1 was not analyzed for detention due to the minimal amount of onsite area and site restrictions. Possible locations for the conceptual basins can be seen in Exhibit 5 of Appendix A. Tables 8 and 9 summarize the results of the detention analysis. Refer to Appendix E for output and a schematic of the detention analysis HEC-HMS model.

Table 8. Detention Analysis Flow and Volume Data.

Return Period (year)	Peak Q In (cfs)	Peak Q Out (cfs)	Allowable Q (cfs)	T _p In (hour)	T _p Out (hour)	Peak Storage (acre-feet)
Basin A1-2						
2	109	62	N / A	12.00	12.25	2.2
10	192	99	97	12.00	12.25	4.0
100	309	139	145	12.00	12.25	6.7
Basin A2						
2	77	44	N / A	11.92	12.17	1.4
10	141	69	69	11.92	12.25	2.7
100	231	97	103	11.92	12.25	4.7
Basin A4-1						
2	162	94	N / A	12.00	12.25	3.5
10	290	152	155	12.00	12.33	6.2
100	470	215	232	12.00	12.33	10.6

*Q = Flow, *cfs = cubic feet per second, *T_p = Time of Peak

Table 9. Detention Analysis Point of Interest Peak Flow Rates.

Point of Interest	Q ₂ (cfs)	T _{p2} (hour)	Q ₁₀ (cfs)	T _{p10} (hour)	Q ₁₀₀ (cfs)	T _{p100} (hour)
Point 1	2,250	12.42	4,277	12.42	7,205	12.42
Point 2	1,839	12.42	3,508	12.42	5,892	12.42

*Q = Flow, *cfs = cubic feet per second, *T_p = Time of Peak

Table 10 compares the results of the detention analysis to the existing conditions analysis from Section 3, at the points of interest. Negative values indicate a reduction in peak flow rate, while positive values indicate an increase. Flow rates for the 100-year event are lower for the detention analysis than for existing conditions at Point 1, and higher at Point 2.

Table 10. Detention Analysis vs. Existing Conditions.

Point of Interest	ΔQ_2 (cfs)	ΔQ_2 %	ΔQ_{10} (cfs)	ΔQ_{10} %	ΔQ_{100} (cfs)	ΔQ_{100} %
Point 1	28	1.26	18	0.42	-24	-0.29
Point 2	29	1.60	34	0.98	14	0.24

* ΔQ = Change in Flow Rate, *cfs = cubic feet per second

4.2 Free Release Analysis

Peak flow rates to the points of interest were also analyzed for free release conditions or without detention basins onsite. Runoff curve numbers, times of concentration, routings, and tributary regions remain the same as in the detention analysis. Table 11 summarizes the results of the free release analysis. Refer to Appendix F for output and a schematic of the free release analysis HEC-HMS model.

Table 11. Free Release Analysis Point of Interest Peak Flow Rates.

Point of Interest	Q_2 (cfs)	Q_{10} (cfs)	Q_{100} (cfs)
Point 1	2,193	4,188	7,098
Point 2	1,790	3,428	5,793

* Q = Flow Rate, *cfs = cubic feet per second

Table 12 compares the results of the free release analysis to the existing conditions from Section 3, at the points of interest. Table 13 compares the results of the detention analysis to the existing conditions from Section 4.1, at the points of interest. Negative values indicate a reduction in peak flow rate, while positive values indicate an increase.

Table 12. Free Release Analysis vs. Existing Conditions.

Point of Interest	ΔQ_2 (cfs)	ΔQ_2 %	ΔQ_{10} (cfs)	ΔQ_{10} %	ΔQ_{100} (cfs)	ΔQ_{100} %
Point 1	-29	-1.31	-71	-1.67	-131	-1.81
Point 2	-20	-1.10	-46	-1.32	-85	-1.45

* ΔQ = Change in Flow Rate, *cfs = cubic feet per second

Table 13. Free Release Analysis vs. Detention Analysis.

Point of Interest	ΔQ_2 (cfs)	ΔQ_2 %	ΔQ_{10} (cfs)	ΔQ_{10} %	ΔQ_{100} (cfs)	ΔQ_{100} %
Point 1	-57	-2.60	-89	-2.13	-107	-1.51
Point 2	-49	-2.74	-80	-2.33	-99	-1.71

* ΔQ = Change in Flow Rate, *cfs = cubic feet per second

The proposed development results in increased curve numbers and decreased times of concentration for subareas A1-2, A2 and A4-1. While this causes an increase in peak discharges for these subareas, it also changes the timing of the peak discharges. In proposed conditions peak discharges from subareas A1-2, A2, and A4-1 occur prior to the peak discharges within Mouse Creek, causing an overall decrease in peak discharges to Point 1 and Point 2 compared to existing conditions.

Construction of detention basins would delay the timing of the peak discharges from the site to closer coincide with peak discharges in Mouse Creek; thus, causing an increase in peak discharges to Point 1 and Point 2.

A waiver is requested for the peak attenuation of stormwater discharge for the proposed development, which has been provided in Appendix G. The free release peak discharges at the comparison points will be reduced to less than existing conditions and less than in the detention analysis. This waiver is also requested due to several challenges in relation to detention design, described below.

- The proposed site is very flat, making it difficult to construct basins to the necessary depth.
- Two tributaries flow through the project site, which results in stormwater generally sheet flowing directly to the tributary, instead of channelizing to create points of discharge where detention can be effective.
- Detention within the channel is not advisable.
- The channel is protected by a stream setback zone and should not be disturbed unless necessary.
- Construction of a dam would provide a barrier for aquatic organism passage and would restrict the travel of aquatic organisms in Mouse Creek and its tributaries.
- Existing sanitary sewer lines follow along both channels and would be located underneath any new detention facility in the channel.

4.3 Extended Detention

In addition to mitigation of peak flow rates, KC-APWA Section 5608.4 also requires 40 hour extended detention of runoff from the local 90% mean annual event (1.37"/24-hour rainfall). Five basins have been graded, locations of which can be seen in Exhibit 6 of Appendix A. Basin sizing and calculations have been provided in Appendix H.

4.4 Impacts to Stream Buffer

Much of the defined stream buffer is not impacted by development. However, a few encroachments have been made to accommodate the proposed layout.

Watershed A

Impacts to the stream buffer within Watershed A will occur toward the middle of the site on the west side. The proximity of the lots to the stream will require an impact to the stream buffer. An asphalt trail will also be constructed as part of the development and will encroach on the stream buffer toward the middle of the site on the east side. The trail is planned just south of a number of lots that are within proximity to the stream. A minimum of 25-foot width of the stream buffer will remain undisturbed, and an equal or greater amount of native vegetation adjacent to the stream buffer will be designated as preserved stream buffer to mitigate for the impacts. Small encroachments made for the installation of storm and sanitary sewers will be replanted with native grasses to restore the vegetation as much as possible.

Watershed B

Impacts to the stream buffer within Watershed B will occur at the northwest corner of the site. The proximity of the lots to the stream will require an impact to the stream buffer. A minimum of 25-foot width of the stream buffer will remain undisturbed, and an equal or greater amount of native vegetation adjacent to the stream buffer will be designated as preserved stream buffer to mitigate for the impacts. Small encroachments made for the installation of storm and sanitary sewers will be replanted with native grasses to restore the vegetation as much as possible.

5.0 SUMMARY

This stormwater drainage study was prepared to evaluate the hydrologic impact generated by the development of Hook Farms and to provide recommendations for a comprehensive stormwater management plan. The project is a 258-lot single family residential development on approximately 160 acres.

A decrease in peak flow rates downstream of the project site is a result of the proposed development. Detention of peak flow rates is not recommended for the proposed development. However, water quality basins will be constructed to provide extended detention of runoff for the local 90% mean annual event.

Stream buffers will be designated based on watershed size, per KC-APWA standards. Where encroachments are necessary, the impacts will be mitigated with preservation of adjacent native vegetation elsewhere on the site, and within the same watershed.

6.0 CONCLUSIONS AND RECOMMENDATIONS

This proposed stormwater management plan was designed to achieve compliance with current design criteria in effect for the City of Lee's Summit, Missouri; however, a waiver is requested for

the peak attenuation of stormwater discharge for the proposed development. A final macro and first plat micro stormwater drainage study will be required with the submittal of the first plat of this development.



The results of the analysis demonstrate that the future stormwater management plan for the project achieves compliance with design criteria or the requested waiver. We therefore request approval of this Hook Farms Preliminary Stormwater Drainage Study. This approval is conditional and should be substantiated with each future plat of Hook Farms.

APPENDIX A

Site Maps

HOOK FARMS FLOODPLAIN MAP EXHIBIT 1

LEGEND

-  PROPERTY BOUNDARY
-  FLOODWAY
-  ZONE AE - 100-YEAR FLOODPLAIN

Source:
FEMA Flood Boundary & Floodway Map
29095C0513G
Effective Date: 01/20/2017

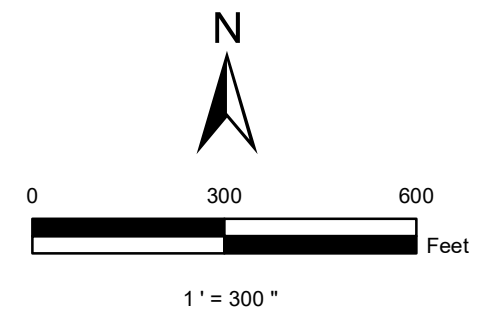

Drawn: jsgian 11/15/2018

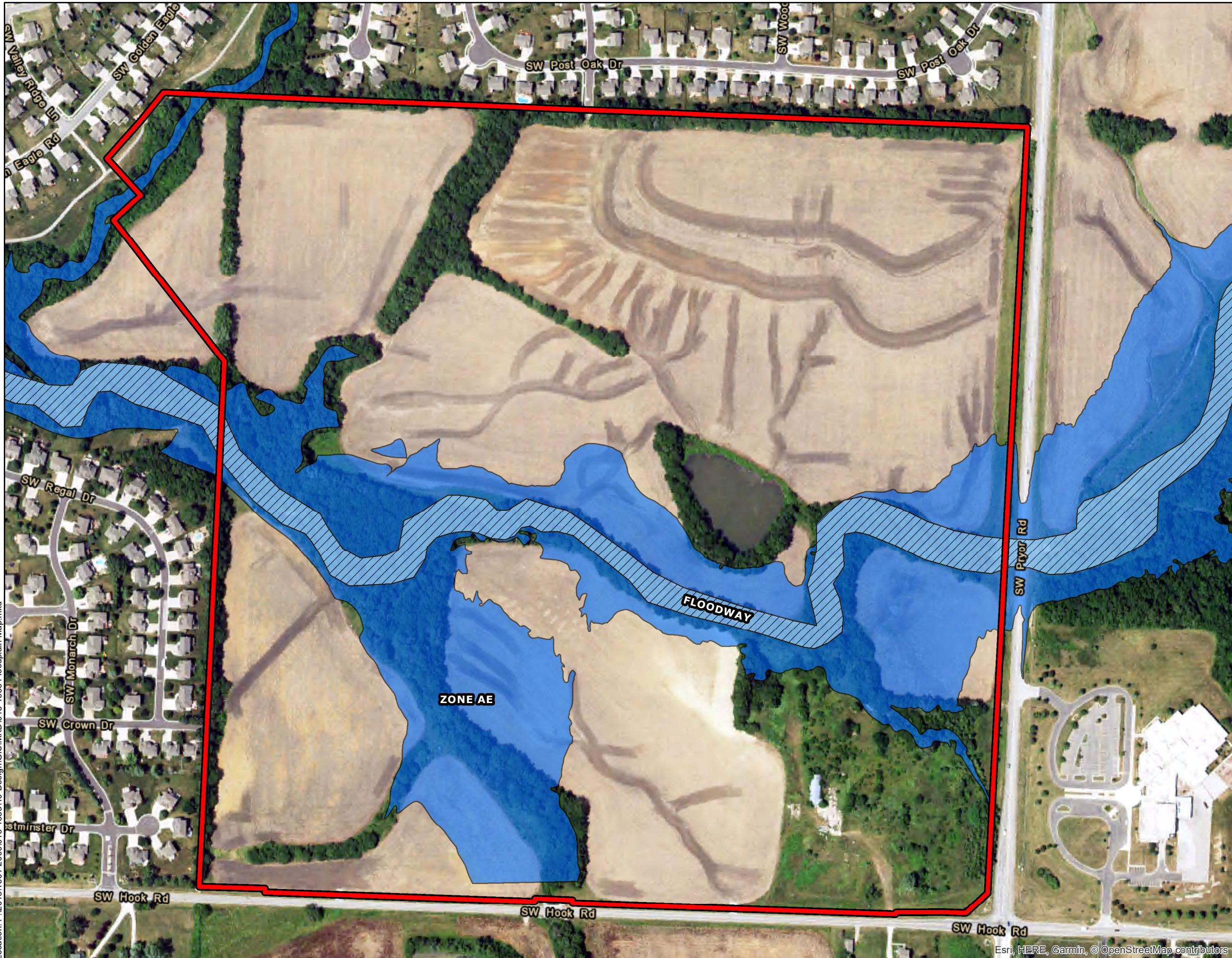

Location: F:\2018\1501-2000\018-1853\40-Design\GIS\IMXD\18-1853 Floodplain Map.mxd

Esri, HERE, Garmin, © OpenStreetMap contributors

Location: F:\2018\1501-2000\018-1853\40-Design\GIS\MXD\1018-1853 Soils Map.mxd

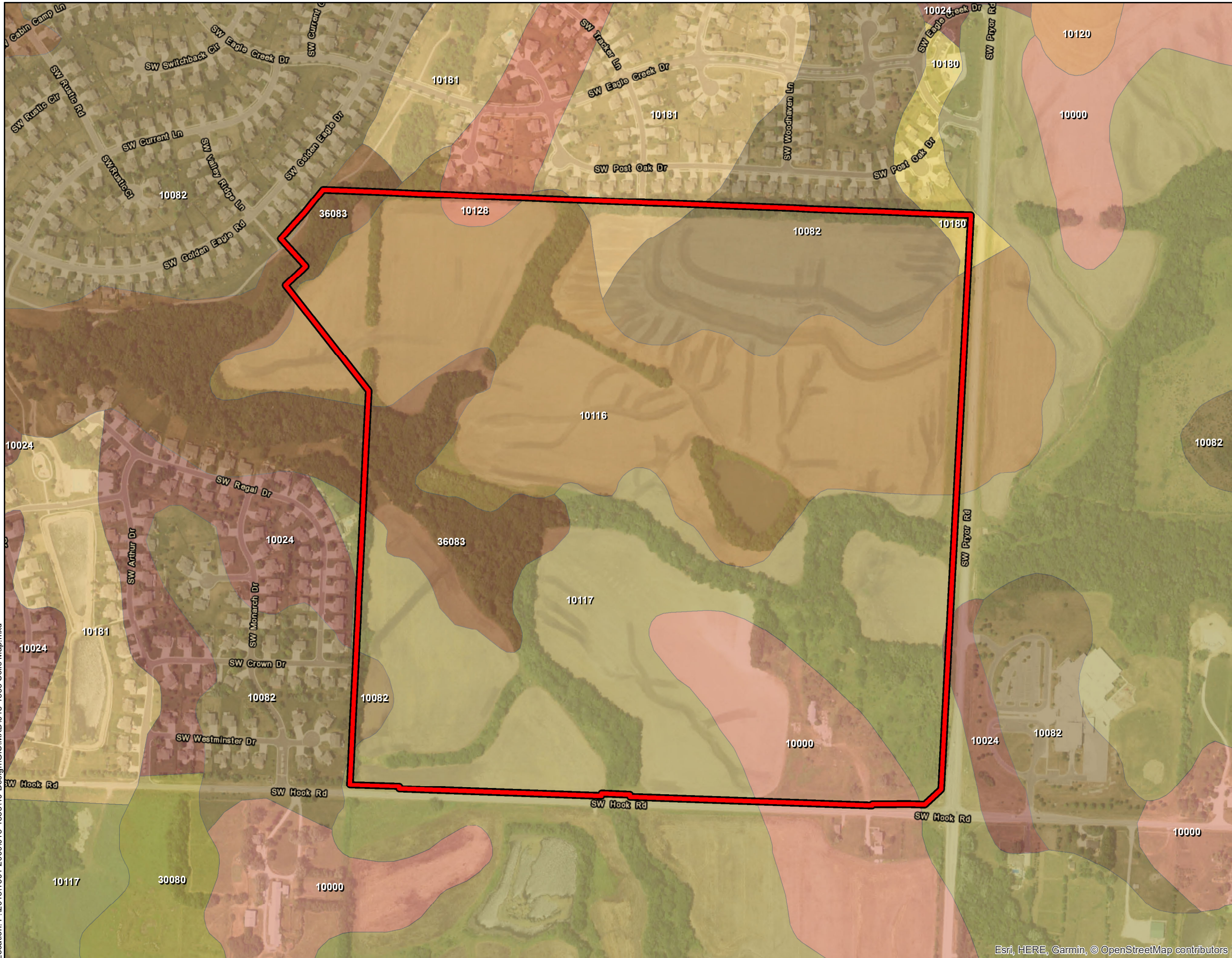













HOOK FARMS

SOIL MAP

EXHIBIT 2

LEGEND

-  PROPERTY BOUNDARY
-  10000 ARISBURG SILT LOAM
1 to 5% SLOPES
-  10124 GREENTON-URBAN LAND COMPLEX
5 to 9% SLOPES
-  10082 ARISBURG-URBAN LAND COMPLEX
1 to 5% SLOPES
-  10116 SAMPSEL SILTY CLAY LOAM
2 to 5% SLOPES
-  10117 SAMPSEL SILTY CLAY LOAM
5 to 9% SLOPES
-  10120 SHARPSBURG SILT LOAM
2 to 5% SLOPES
-  10128 SHARPSBURG-URBAN LAND COMPLEX
2 to 5% SLOPES
-  10180 UDARENTS-URBAN LAND-SAMPSEL COMPLEX
2 to 5% SLOPES
-  10180 UDARENTS-URBAN LAND-SAMPSEL COMPLEX
5 to 9% SLOPES
-  30080 GREENTON SILTY CLAY LOAM
5 to 9% SLOPES
-  10180 KENNEBEC SILT LOAM
1 to 4% SLOPES

Source:
Soil Survey of Jackson County, Missouri

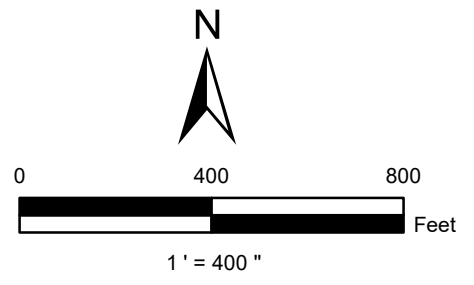

Drawn: jasgian 11/15/2018













HOOK FARMS

EXISTING CONDITIONS

DRAINAGE MAP

EXHIBIT 3

LEGEND

-  PROPERTY BOUNDARY
 -  FUTURE COMMERCIAL BOUNDARY
 -  WATERSHED A BOUNDARY
 -  WATERSHED B BOUNDARY
 -  SUB-WATERSHED BOUNDARY
 -  EXISTING 20-FT CONTOURS
 -  FLOW PATH
- LAND USE**
-  AGRICULTURAL
 -  COMMERCIAL
 -  MULTIFAMILY RESIDENTIAL
 -  PUBLIC/SEMI-PUBLIC
 -  ROAD/RIGHT-OF-WAY
 -  SINGLE FAMILY RESIDENTIAL
 -  UNDEVELOPED

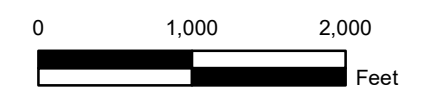

1" = 1,250"

Drawn: jasgian 11/15/2018

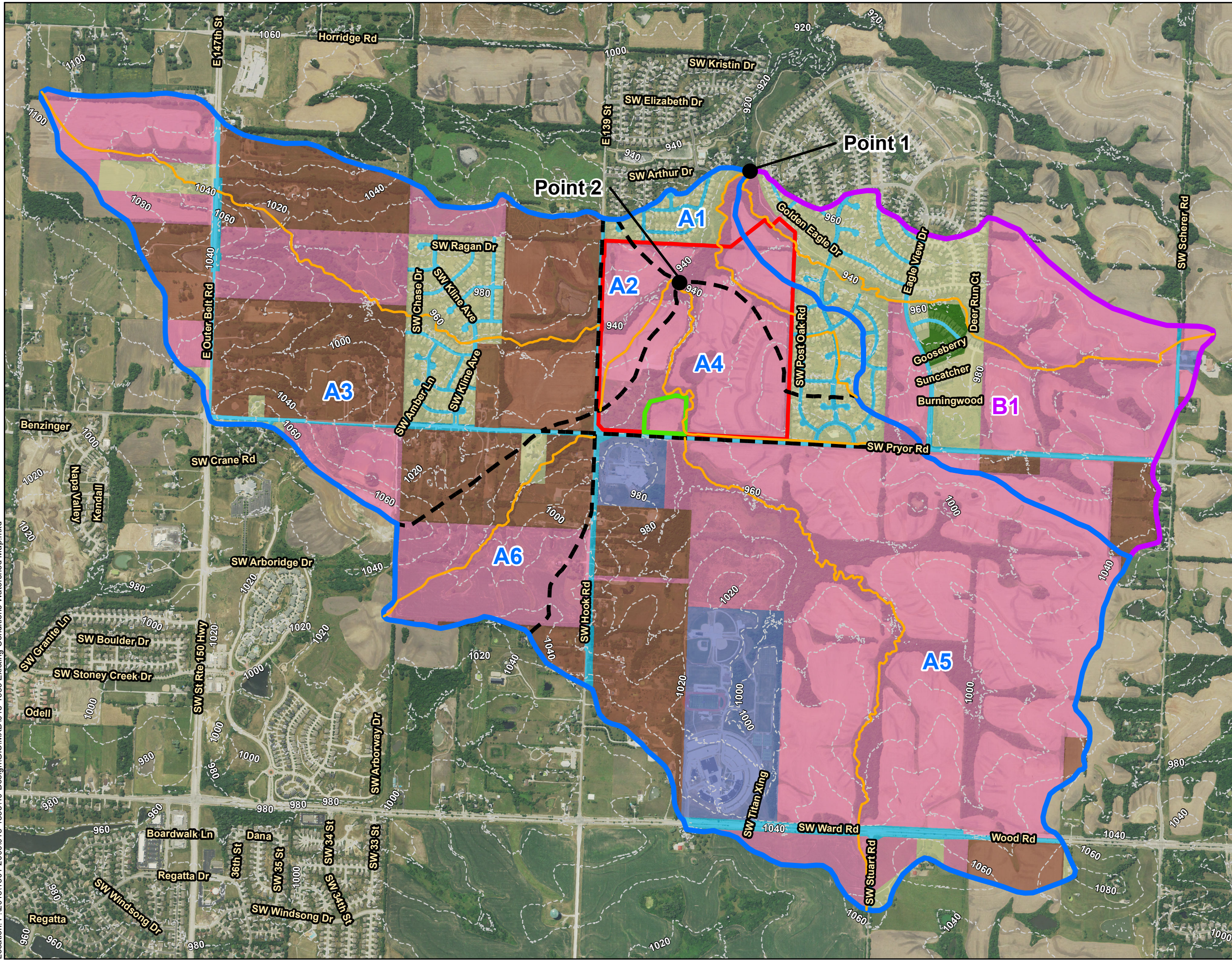

Location: F:\2018\1501-2000\018-1853\40-Design\GIS\MXD\1018-1853 Existing Conditions Watershed Map.mxd

HOOK FARMS PROPOSED CONDITIONS DRAINAGE MAP EXHIBIT 4

LEGEND

-  PROPERTY BOUNDARY
 -  FUTURE COMMERCIAL BOUNDARY
 -  WATERSHED A BOUNDARY
 -  WATERSHED B BOUNDARY
 -  PROPOSED SUB-WATERSHED BOUNDARY
 -  PROPOSED 10-FT CONTOURS
 -  EXISTING 20-FT CONTOURS
 -  FLOW PATH
- LAND USE**
-  AGRICULTURAL
 -  COMMERCIAL
 -  MULTIFAMILY RESIDENTIAL
 -  PUBLIC/SEMI-PUBLIC
 -  ROAD/RIGHT-OF-WAY
 -  SINGLE FAMILY RESIDENTIAL
 -  UNDEVELOPED

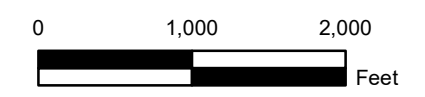
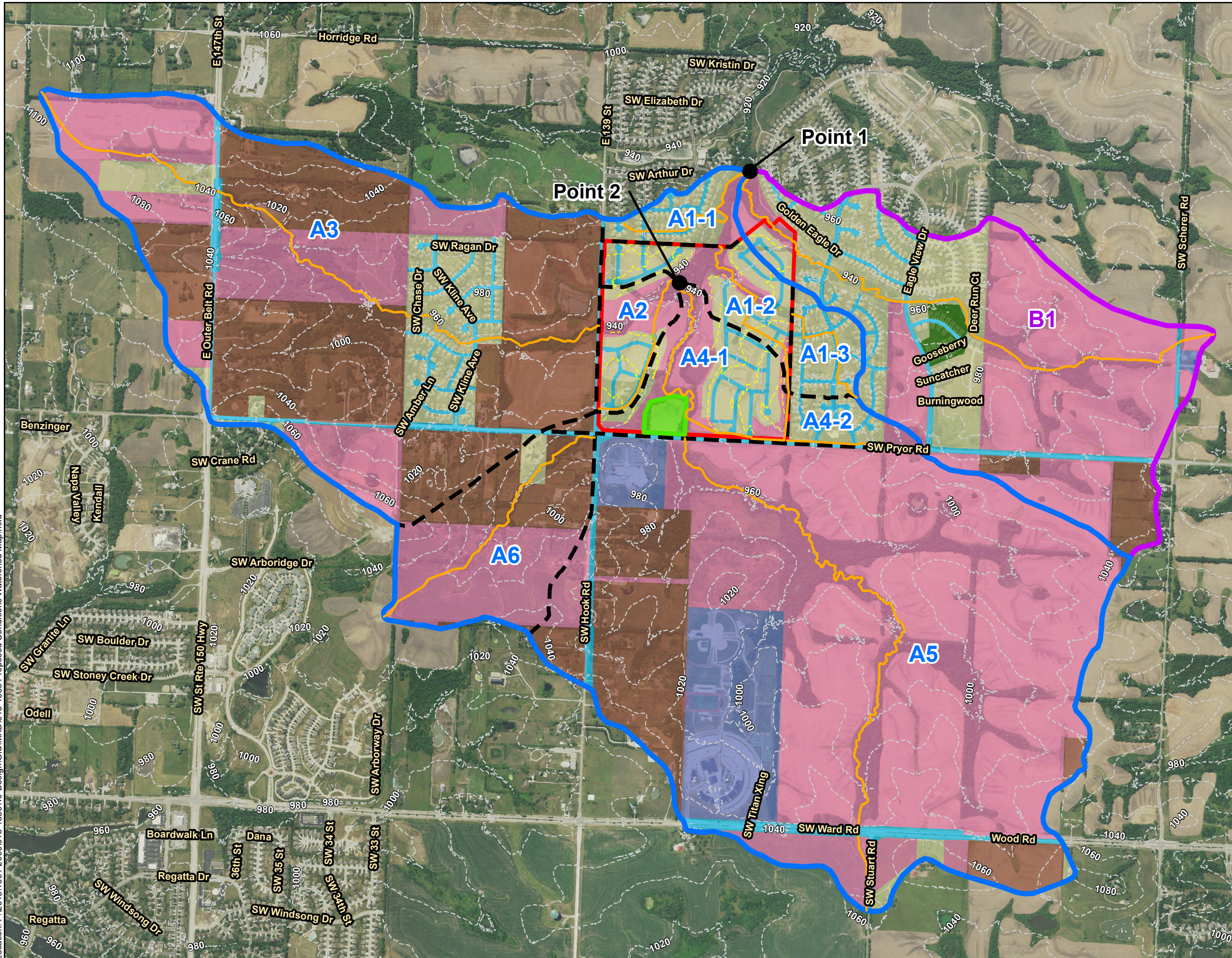

1" = 1,250'





Drawn: jasgian 3/26/2019



Location: F:\2018\1501-2000\018-1853\40-Design\GIS\MXD\1018-1853 Proposed Conditions Watershed Map.mxd

HOOK FARMS CONCEPTUAL DETENTION BASINS EXHIBIT 5

LEGEND

-  PROPERTY BOUNDARY
-  CONCEPTUAL BASINS
-  PROPOSED RIGHT-OF-WAY
-  PROPOSED 2-FT CONTOURS
-  EXISTING 10-FT CONTOURS

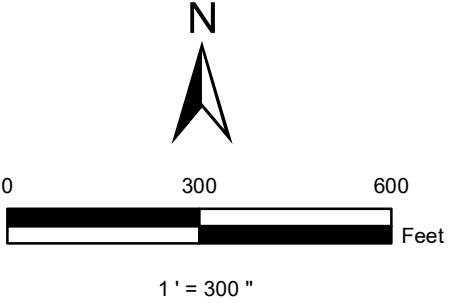
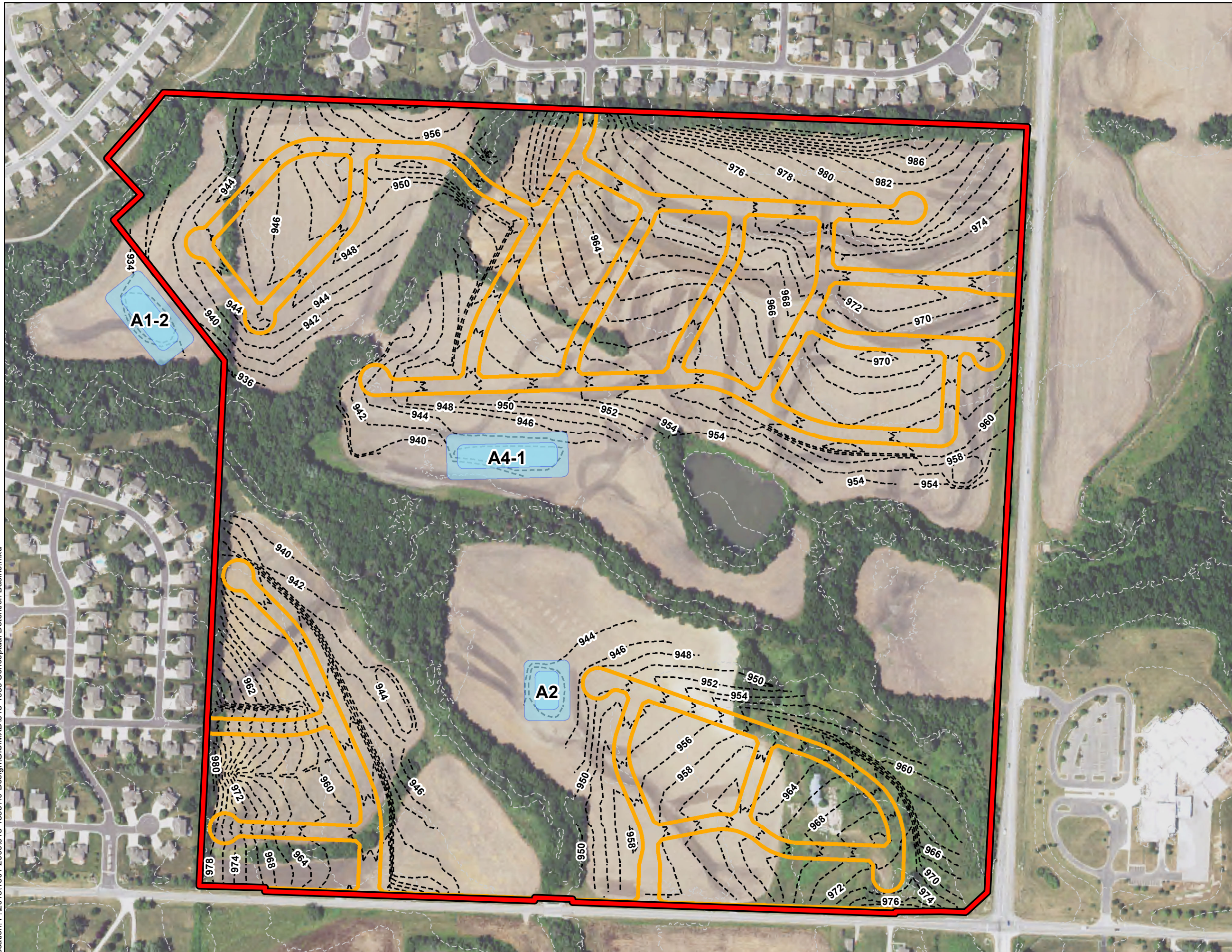





Drawn: jasgian 3/27/2019



Location: F:\2018\1501-2000\018-1853\40-Design\GIS\IMXD\10-1853-Conceptual Detention Basins.mxd

HOOK FARMS WATER QUALITY BASINS EXHIBIT 5

LEGEND

-  PROPERTY BOUNDARY
-  WATER QUALITY BASINS
-  PROPOSED RIGHT-OF-WAY
-  EXISTING 10-FT CONTOURS

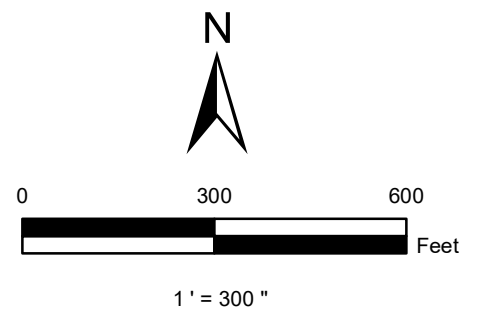
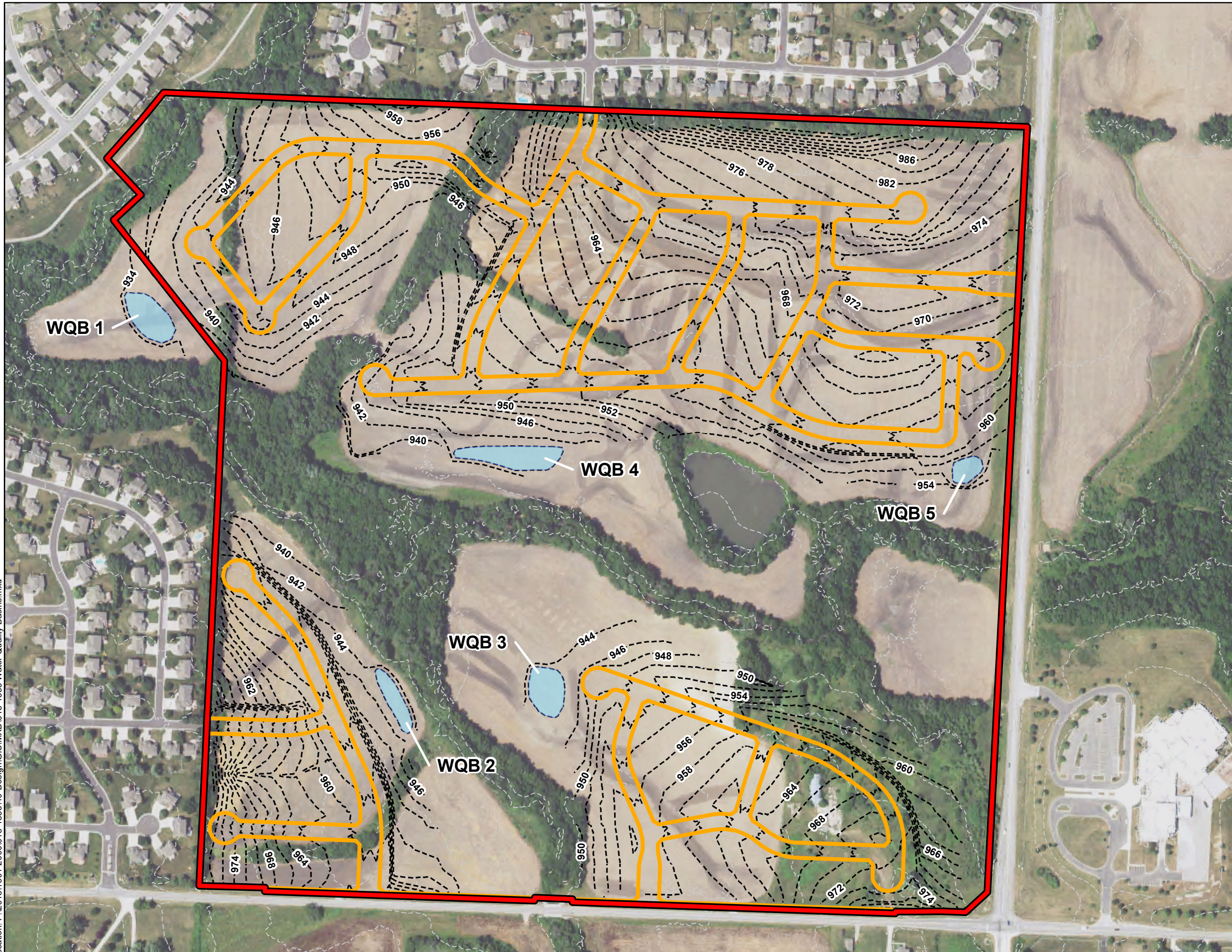

Drawn: jasgian 3/27/2019



Location: F:\2018\1501-2000\018-1853\40-Design\GIS\IMXD\18-1853\Water Quality Basins.mxd

APPENDIX B

Existing Conditions TR-55
Inputs and Results

Subarea A1

	Length (ft)	Slope (ft/ft)	Surface (Manning's n)	Velocity (ft/s)	Time (hr)
Sheet	100	0.0250	Grass -Range Short (0.15)		0.143
Shallow Concentrated	145	0.0700	Unpaved		0.009
Channel	4,887			7.000	0.194
Total	5,132			4.1201	0.346

Subarea A2

	Length (ft)	Slope (ft/ft)	Surface (Manning's n)	Velocity (ft/s)	Time (hr)
Sheet	100	0.0200	Grass -Range Short (0.15)		0.156
Shallow Concentrated	554	0.0380	Unpaved		0.049
Channel	1,650			7.000	0.065
Total	2,304			2.3704	0.270

Subarea A3

	Length (ft)	Slope (ft/ft)	Surface (Manning's n)	Velocity (ft/s)	Time (hr)
Sheet	100	0.0100	Grass Dense (0.24)		0.300
Shallow Concentrated	861	0.0140	Unpaved		0.125
Channel	8,567			7.000	0.340
Total	9,528			3.4597	0.765

Subarea A4

	Length (ft)	Slope (ft/ft)	Surface (Manning's n)	Velocity (ft/s)	Time (hr)
Sheet	100	0.0230	Grass -Range Short (0.15)		0.148
Shallow Concentrated	150	0.0400	Unpaved		0.013
Channel	5,987			7.000	0.238
Total	6,237			4.3421	0.399

Subarea A5

	Length (ft)	Slope (ft/ft)	Surface (Manning's n)	Velocity (ft/s)	Time (hr)
Sheet	100	0.0060	Grass Dense (0.24)		0.368
Shallow Concentrated	266	0.0170	Unpaved		0.035
Channel	9,537			7.000	0.378
Total	9,903			3.5222	0.781

Subarea A6

	Length (ft)	Slope (ft/ft)	Surface (Manning's n)	Velocity (ft/s)	Time (hr)
Sheet	100	0.0200	Grass Dense (0.24)		0.227
Shallow Concentrated	483	0.0120	Unpaved		0.076
Channel	3,593			7.000	0.143
Total	4,176			2.6009	0.446

Subarea B1

	Length (ft)	Slope (ft/ft)	Surface (Manning's n)	Velocity (ft/s)	Time (hr)
Sheet	100	0.0190	Grass Dense (0.24)		0.232
Shallow Concentrated	570	0.0190	Unpaved		0.071
Channel	8,061			7.000	0.320
Total	8,731			3.8929	0.623

APPENDIX C

Existing Conditions HEC-HMS Model Inputs and Results

Existing Conditions HEC-HMS Model Schematic

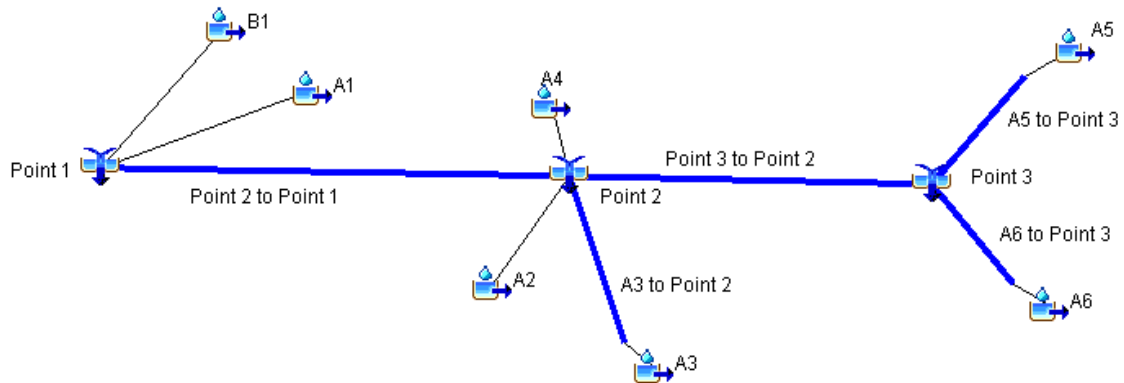

Existing Conditions HEC-HMS Inputs

Sub-Basin Inputs

	A1	A2	A3	A4	A5	A6	B1
Area (MI ²)	0.1347	0.0606	0.9253	0.1785	1.3405	0.1849	0.5743
Downstream	Point 1	Point 2	A3 to Point 2	Point 2	A5 to Point 3	A6 to Point 3	Point 1
Loss Method	SCS Curve Number						
Transform Method	SCS Unit Hydrograph						
Curve Number	82	80	80	80	80	79	81
Graph Type	Standard (PRF 484)						
Lag Time (MIN)	12.5	9.7	27.5	14.4	28.1	16.1	22.4

Reach Inputs

	A6 to Point 3	A5 to Point 3	Point 3 to Point 2	A3 to Point 2	Point 2 to Point 1
Downstream	Point 3	Point 3	Point 2	Point 2	Point 1
Time Step Method	Automatic Fixed Interval				
Length (FT)	1,137	1,141	1,861	1,465	2,225
Slope (FT/FT)	0.0126	0.0076	0.0048	0.0082	0.0033
Manning's n	0.048	0.048	0.048	0.048	0.048
Shape	Eight Point				
Left Manning's n	0.048	0.048	0.048	0.048	0.048
Right Manning's n	0.048	0.048	0.048	0.048	0.048
Cross Section	A6 to Point 3	A5 to Point 3	Point 3 to Point 2	A3 to Point 2	Point 2 to Point 1

Junction Inputs

	Point 3	Point 2	Point 1
Downstream	Point 3 to Point 2	Point 2 to Point 1	None

Meteorological Models

	SCS 2-Year	SCS 10-Year	SCS 100-Year
Precipitation	SCS Storm		
Unit System	U.S. Customary		
Replace Missing	Abort Compute		
Method	Type 2		
Depth (IN)	3.6	5.4	7.9

Control Specifications

	24-Hour Storm
Start Date (dd/MMM/YYYY)	01Jan2018
Start Time (HH:mm)	00:00
End Date (dd/MMM/YYYY)	02Jan2018
End Time (HH:mm)	01:00
Time Interval	5 Minutes

Paired Data (Cross-Section) Table 1

	A6 to Point 3
Data Source	Manual Entry
Units	FT : FT
Station (FT)	Elevation (FT)
144.05	953.42
170.24	947.63
180.07	949.00
193.16	948.86
212.81	949.89
225.90	951.69
242.27	950.88
261.94	951.410

Paired Data (Cross-Section) Table 2

	A5 to Point 3
Data Source	Manual Entry
Units	FT : FT
Station (FT)	Elevation (FT)
91.64	949.55
94.36	949.46
97.33	948.76
110.31	940.97
116.80	940.37
155.73	949.20
171.95	949.36
188.18	951.24

Paired Data (Cross-Section) Table 3

	Point 3 to Point 2
Data Source	Manual Entry
Units	FT : FT
Station (FT)	Elevation (FT)
52.37	943.93
104.74	943.13
130.93	938.58
150.56	932.79
176.75	938.61
193.12	942.31
232.39	943.17
255.31	943.03

Paired Data (Cross-Section) Table 4

	A3 to Point 2
Data Source	Manual Entry
Units	FT : FT
Station (FT)	Elevation (FT)
25.81	944.02
70.99	941.56
106.49	943.59
122.62	938.98
141.98	937.01
161.34	943.78
190.27	942.52
280.07	943.76

Paired Data (Cross-Section) Table 5

	Point 2 to Point 1
Data Source	Manual Entry
Units	FT : FT
Station (FT)	Elevation (FT)
68.18	938.05
97.39	933.21
100.64	933.21
136.35	936.26
146.09	935.85
152.58	936.23
162.32	935.96
168.82	936.86

Existing Conditions HEC-HMS Results**Results – Point 1**

	2-Year	10-Year	100-Year
Peak Discharge (CFS)	2,222.2	4,259.0	7,228.5
Volume (IN)	1.73	3.26	5.55
Date/Time of Peak Discharge	01Jan2018, 12:25	01Jan2018, 12:25	01Jan2018, 12:25

Results – Point 2

	2-Year	10-Year	100-Year
Peak Discharge (CFS)	1,810.1	3,474.2	5,878.4
Volume (IN)	1.71	3.23	5.52
Date/Time of Peak Discharge	01Jan2018, 12:25	01Jan2018, 12:25	01Jan2018, 12:25

APPENDIX D

Proposed Conditions TR-55
Inputs and Results

Subarea A1-1

	Length (ft)	Slope (ft/ft)	Surface (Manning's n)	Velocity (ft/s)	Time (hr)
Sheet	100	0.0800	Grass-Range Short (0.15)		0.090
Shallow Concentrated	176	0.0247	Unpaved		0.019
Channel	2,310			10.000	0.064
Total	2,586			4.1522	0.173

Subarea A1-2

	Length (ft)	Slope (ft/ft)	Surface (Manning's n)	Velocity (ft/s)	Time (hr)
Sheet	100	0.0182	Grass-Range Short (0.15)		0.162
Shallow Concentrated	566	0.0285	Unpaved		0.058
Channel	2,166			10.000	0.060
Total	2,832			2.8095	0.280

Subarea A1-3

	Length (ft)	Slope (ft/ft)	Surface (Manning's n)	Velocity (ft/s)	Time (hr)
Sheet	100	0.0274	Grass-Range Short (0.15)		0.138
Shallow Concentrated	146	0.0690	Unpaved		0.010
Channel	1,753			10.000	0.049
Total	1,753			2.8187	0.197

Subarea A2

	Length (ft)	Slope (ft/ft)	Surface (Manning's n)	Velocity (ft/s)	Time (hr)
Sheet	100	0.0225	Grass-Range Short (0.15)		0.149
Shallow Concentrated	300	0.0225	Paved		0.027
Channel	1,650			7.000	0.065
Total	2,050			2.3628	0.241

Subarea A3

	Length (ft)	Slope (ft/ft)	Surface (Manning's n)	Velocity (ft/s)	Time (hr)
Sheet	100	0.0100	Grass Dense (0.24)		0.300
Shallow Concentrated	861	0.0140	Unpaved		0.125
Channel	8,567			7.000	0.340
Total	9,528			3.4597	0.765

Subarea A4-1

	Length (ft)	Slope (ft/ft)	Surface (Manning's n)	Velocity (ft/s)	Time (hr)
Sheet	100	0.0339	Grass-Range Short (0.15)		0.126
Shallow Concentrated	561	0.0345	Unpaved		0.052
Channel	4,162			7.000	0.165
Total	4,823			3.9059	0.343

Subarea A4-2

	Length (ft)	Slope (ft/ft)	Surface (Manning's n)	Velocity (ft/s)	Time (hr)
Sheet	100	0.0259	Grass-Range Short (0.15)		0.141
Shallow Concentrated	150	0.0402	Unpaved		0.013
Channel	1,596			10.000	0.044
Total	1,846			2.5898	0.198

Subarea A5

	Length (ft)	Slope (ft/ft)	Surface (Manning's n)	Velocity (ft/s)	Time (hr)
Sheet	100	0.0060	Grass Dense (0.24)		0.368
Shallow Concentrated	266	0.0170	Unpaved		0.035
Channel	9,537			7.000	0.378
Total	9,903			3.5222	0.781

Subarea A6

	Length (ft)	Slope (ft/ft)	Surface (Manning's n)	Velocity (ft/s)	Time (hr)
Sheet	100	0.0200	Grass Dense (0.24)		0.227
Shallow Concentrated	483	0.0120	Unpaved		0.076
Channel	3,593			7.000	0.143
Total	4,176			2.6009	0.446

Subarea B1

	Length (ft)	Slope (ft/ft)	Surface (Manning's n)	Velocity (ft/s)	Time (hr)
Sheet	100	0.0190	Grass Dense (0.24)		0.232
Shallow Concentrated	570	0.0190	Unpaved		0.071
Channel	8,061			7.000	0.320
Total	8,731			3.8929	0.623

APPENDIX E

Detention Analysis HEC-HMS Model Inputs and Results

Detention Analysis HEC-HMS Model Schematic

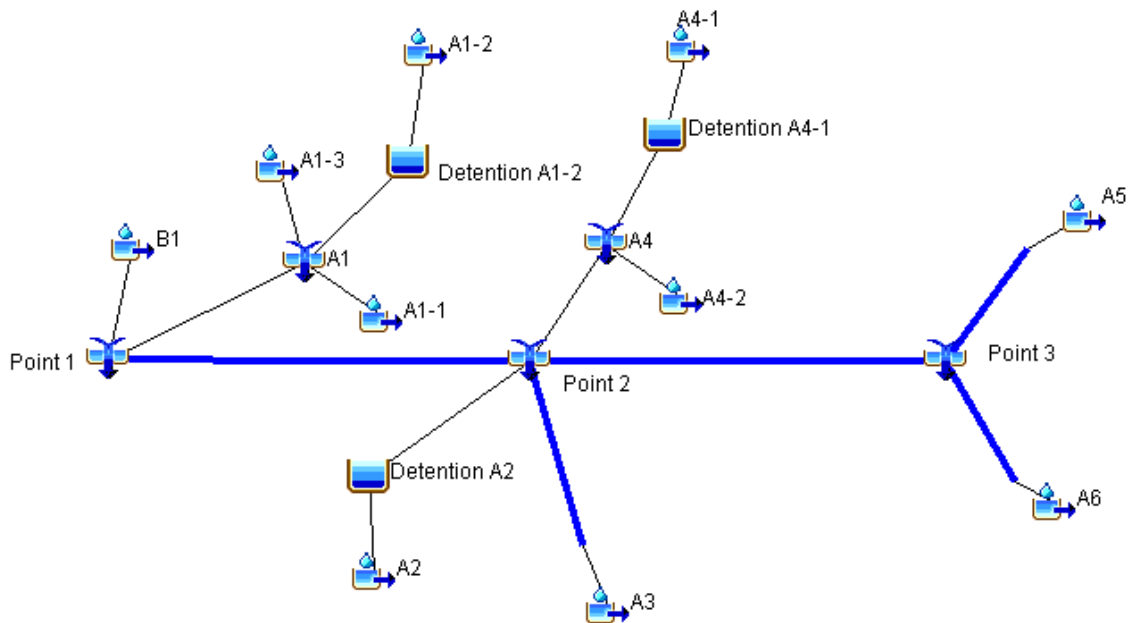

Detention Analysis HEC-HMS Inputs

Sub-Basin Inputs

	A1-1	A1-2	A1-3	A2	A3	A4-1	A4-2	A5	A6	B1
Area (MI ²)	0.045 7	0.075 5	0.043 7	0.053 8	0.925 3	0.120 8	0.034 5	1.340 5	0.184 9	0.574 1
Downstream	A1	Detention -ion A1-2	A1	Detention -ion A2	A3 to Point 2	Detention -ion A4-1	A4	A5 to Point 3	A6 to Point 3	Point 1
Loss Method	SCS Curve Number									
Transform Method	SCS Unit Hydrograph									
Curve Number	84	84	89	83	80	84	85	80	79	81
Graph Type	Standard (PRF 484)									
Lag Time (MIN)	6.3	10.1	7.1	8.7	27.5	12.3	7.1	28.1	16.1	22.4

Junction Inputs

	A1	A4	Point 3	Point 2	Point 1
Downstream	Point 1	Point 2	Point 3 to Point 2	Point 2 to Point 1	None

Reach Inputs

	A6 to Point 3	A5 to Point 3	Point 3 to Point 2	A3 to Point 2	Point 2 to Point 1
Downstream	Point 3	Point 3	Point 2	Point 2	Point 1
Time Step Method	Automatic Fixed Interval				
Length (FT)	1,137	1,141	1,861	1,465	2,225
Slope (FT/FT)	0.0126	0.0076	0.0048	0.0082	0.0033
Manning's n	0.048	0.048	0.048	0.048	0.048
Shape	Eight Point				
Left Manning's n	0.048	0.048	0.048	0.048	0.048
Right Manning's n	0.048	0.048	0.048	0.048	0.048
Cross Section	A6 to Point 3	A5 to Point 3	Point 3 to Point 2	A3 to Point 2	Point 2 to Point 1

Reservoir Inputs

	Detention A1-2	Detention A2	Detention A4-1
Downstream	A1	Point 2	A4
Method	Outflow Structures		
Storage Method	Elevation Area		
Elev-Area Function	A1-2	A2	A4-1
Initial Condition	Inflow = Outflow		
Main Tailwater	Assume None		
Auxiliary	None		
Time Step Method	Automatic Adaptation		
Outlets	1	1	1
Spillways	0	0	0
Dam Tops	0	0	0
Pumps	0	0	0
Dam Break	No	No	No
Dam Seepage	No	No	No
Release	No	No	No
Evaporation	No	No	No

Reservoir Outlets

	Detention A1-2	Detention A2	Detention A4-1
Method	Culvert Outlet		
Direction	Main		
Number Barrels	2	2	2
Solution Method	Automatic		
Shape	Circular		
Chart	1: Concrete Pipe Culvert		
Scale	1: Square Edge Entrance with Headwall		
Length (FT)	100	100	100
Diameter (FT)	2.5	2	3
Inlet Elevation (FT)	940	940	940
Entrance Coefficient	0.4	0.4	0.4
Outlet Elevation (FT)	939	939	939
Exit Coefficient	1	1	1
Manning's n	0.013	0.013	0.013

Meteorological Models

	SCS 2-Year	SCS 10-Year	SCS 100-Year
Precipitation	SCS Storm		
Unit System	U.S. Customary		
Replace Missing	Abort Compute		
Method	Type 2		
Depth (IN)	3.6	5.4	7.9

Control Specifications

	24-Hour Storm
Start Date (dd/MMM/YYYY)	01Jan2018
Start Time (HH:mm)	00:00
End Date (dd/MMM/YYYY)	02Jan2018
End Time (HH:mm)	01:00
Time Interval	5 Minutes

Paired Data (Cross-Section) Table 1

	A6 to Point 3
Data Source	Manual Entry
Units	FT : FT
Station (FT)	Elevation (FT)
144.05	953.42
170.24	947.63
180.07	949.00
193.16	948.86
212.81	949.89
225.90	951.69
242.27	950.88
261.94	951.41

Paired Data (Cross-Section) Table 2

	A5 to Point 3
Data Source	Manual Entry
Units	FT : FT
Station (FT)	Elevation (FT)
91.64	949.55
94.36	949.46
97.33	948.76
110.31	940.97
116.80	940.37
155.73	949.20
171.95	949.36
188.18	951.24

Paired Data (Cross-Section) Table 3

	Point 3 to Point 2
Data Source	Manual Entry
Units	FT : FT
Station (FT)	Elevation (FT)
52.37	943.93
104.74	943.13
130.93	938.58
150.56	932.79
176.75	938.61
193.12	942.31
232.39	943.17
255.31	943.03

Paired Data (Cross-Section) Table 4

	A3 to Point 2
Data Source	Manual Entry
Units	FT : FT
Station (FT)	Elevation (FT)
25.81	944.02
70.99	941.56
106.49	943.59
122.62	938.98
141.98	937.01
161.34	943.78
190.27	942.52
280.07	943.76

Paired Data (Cross-Section) Table 5

	Point 2 to Point 1
Data Source	Manual Entry
Units	FT : FT
Station (FT)	Elevation (FT)
68.18	938.05
97.39	933.21
100.64	933.21
136.35	936.26
146.09	935.85
152.58	936.23
162.32	935.96
168.82	936.86

Paired Data (Elevation-Area) Table 1

	A1-2
Data Source	Manual Entry
Units	FT : AC
Elevation (FT)	Area (FT)
940.0	0.40
952.0	1.03

Paired Data (Elevation-Area) Table 2

	A2
Data Source	Manual Entry
Units	FT : AC
Elevation (FT)	Area (FT)
940.0	0.22
952.0	0.68

Paired Data (Elevation-Area) Table 3

	A1-2
Data Source	Manual Entry
Units	FT : AC
Elevation (FT)	Area (FT)
940.0	0.40
952.0	1.03

Detention Analysis HEC-HMS Results**Results – Point 1**

	2-Year	10-Year	100-Year
Peak Discharge (CFS)	2,249.7	4,276.5	7,204.8
Volume (IN)	1.76	3.30	5.59
Date/Time of Peak Discharge	01Jan2018, 12:25	01Jan2018, 12:25	01Jan2018, 12:25

Results – Point 2

	2-Year	10-Year	100-Year
Peak Discharge (CFS)	1,839.0	3,508.4	5,891.7
Volume (IN)	1.73	3.26	5.55
Date/Time of Peak Discharge	01Jan2018, 12:25	01Jan2018, 12:25	01Jan2018, 12:25

APPENDIX F

Free Release Analysis
HEC-HMS Model Inputs and Results

Free Release Analysis HEC-HMS Model Schematic

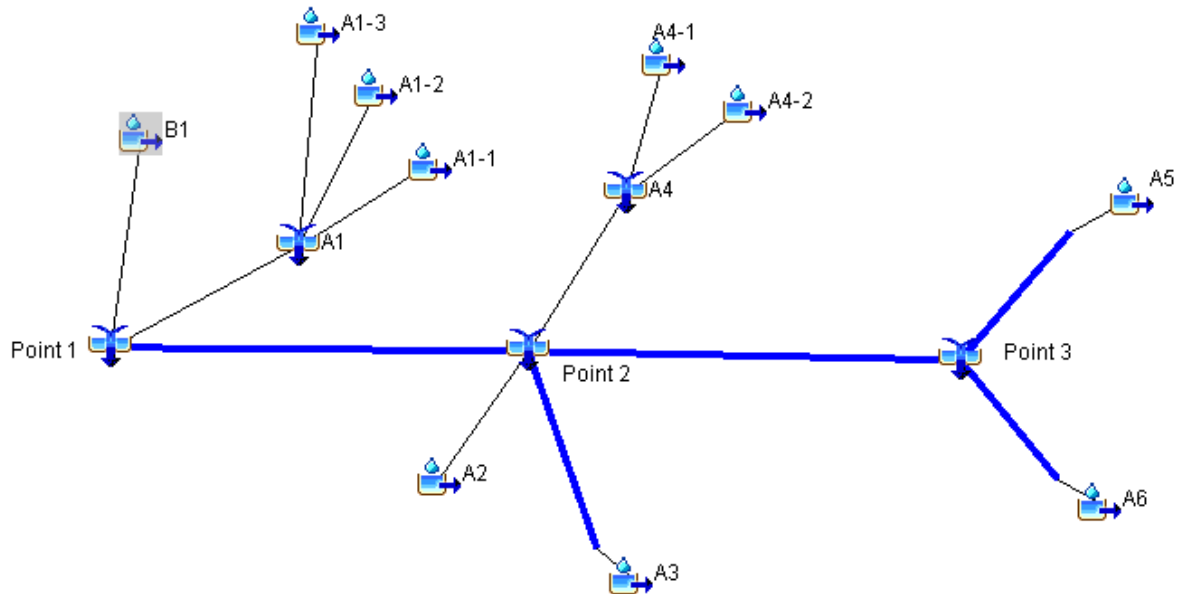

Free Release Analysis HEC-HMS Inputs

Sub-Basin Inputs

	A1-1	A1-2	A1-3	A2	A3	A4-1	A4-2	A5	A6	B1
Area (MI ²)	0.0457	0.0755	0.0437	0.0538	0.9253	0.1208	0.0345	1.3405	0.1849	0.5741
Downstream	A1	A1	A1	Point 2	A3 to Point 2	A4	A4	A5 to Point 3	A6 to Point 3	Point 1
Loss Method	SCS Curve Number									
Transform Method	SCS Unit Hydrograph									
Curve Number	84	84	89	83	80	84	85	80	79	81
Graph Type	Standard (PRF 484)									
Lag Time (MIN)	6.3	10.1	7.1	8.7	27.5	12.3	7.1	28.1	16.1	22.4

Reach Inputs

	A6 to Point 3	A5 to Point 3	Point 3 to Point 2	A3 to Point 2	Point 2 to Point 1
Downstream	Point 3	Point 3	Point 2	Point 2	Point 1
Time Step Method	Automatic Fixed Interval				
Length (FT)	1,137	1,141	1,861	1,465	2,225
Slope (FT/FT)	0.0126	0.0076	0.0048	0.0082	0.0033
Manning's n	0.048	0.048	0.048	0.048	0.048
Shape	Eight Point				
Left Manning's n	0.048	0.048	0.048	0.048	0.048
Right Manning's n	0.048	0.048	0.048	0.048	0.048
Cross Section	A6 to Point 3	A5 to Point 3	Point 3 to Point 2	A3 to Point 2	Point 2 to Point 1

Junction Inputs

	A1	A4	Point 3	Point 2	Point 1
Downstream	Point 1	Point 2	Point 3 to Point 2	Point 2 to Point 1	None

Meteorological Models

	SCS 2-Year	SCS 10-Year	SCS 100-Year
Precipitation	SCS Storm		
Unit System	U.S. Customary		
Replace Missing	Abort Compute		
Method	Type 2		
Depth (IN)	3.6	5.4	7.9

Control Specifications

	24-Hour Storm
Start Date (dd/MMM/YYYY)	01Jan2018
Start Time (HH:mm)	00:00
End Date (dd/MMM/YYYY)	02Jan2018
End Time (HH:mm)	01:00
Time Interval	5 Minutes

Paired Data (Cross-Section) Table 1

	A6 to Point 3
Data Source	Manual Entry
Units	FT : FT
Station (FT)	Elevation (FT)
144.05	953.42
170.24	947.63
180.07	949.00
193.16	948.86
212.81	949.89
225.90	951.69
242.27	950.88
261.94	951.41

Paired Data (Cross-Section) Table 2

	A5 to Point 3
Data Source	Manual Entry
Units	FT : FT
Station (FT)	Elevation (FT)
91.64	949.55
94.36	949.46
97.33	948.76
110.31	940.97
116.80	940.37
155.73	949.20
171.95	949.36
188.18	951.24

Paired Data (Cross-Section) Table 3

	Point 3 to Point 2
Data Source	Manual Entry
Units	FT : FT
Station (FT)	Elevation (FT)
52.37	943.93
104.74	943.13
130.93	938.58
150.56	932.79
176.75	938.61
193.12	942.31
232.39	943.17
255.31	943.03

Paired Data (Cross-Section) Table 4

	A3 to Point 2
Data Source	Manual Entry
Units	FT : FT
Station (FT)	Elevation (FT)
25.81	944.02
70.99	941.56
106.49	943.59
122.62	938.98
141.98	937.01
161.34	943.78
190.27	942.52
280.07	943.76

Paired Data (Cross-Section) Table 5

	Point 2 to Point 1
Data Source	Manual Entry
Units	FT : FT
Station (FT)	Elevation (FT)
68.18	938.05
97.39	933.21
100.64	933.21
136.35	936.26
146.09	935.85
152.58	936.23
162.32	935.96
168.82	936.86

Free Release Analysis HEC-HMS Results

Results – Point 1

	2-Year	10-Year	100-Year
Peak Discharge (CFS)	2,193.0	4,187.5	7,098.1
Volume (IN)	1.76	3.30	5.60
Date/Time of Peak Discharge	01Jan2018, 12:25	01Jan2018, 12:25	01Jan2018, 12:25

Results – Point 2

	2-Year	10-Year	100-Year
Peak Discharge (CFS)	1,789.7	3,427.6	5,792.9
Volume (IN)	1.73	3.26	5.55
Date/Time of Peak Discharge	01Jan2018, 12:25	01Jan2018, 12:25	01Jan2018, 12:25

APPENDIX G

Waiver Request



LEE'S SUMMIT MISSOURI

DESIGN AND CONSTRUCTION MANUAL DESIGN MODIFICATION REQUEST

PROJECT NAME: Hook Farms

PREMISE ADDRESS: 2020 SW Hook Road, Lee's Summit, MO 64082

PERMIT NUMBER: _____

OWNER'S NAME: Hunt Midwest Real Estate Development, Inc.

TO: The City Engineer

In accordance with the Lee's Summit Design and Construction Manual (DCM) Section 1002.A, I wish to apply for a modification to one or more specification (s). The following articulates my request for your review and action. (NOTE: Cite specific code sections and engineering justification and drawings.)
A waiver is requested for detention at the site (outlined in Section 5608 of KC-APWA 5600). The peak discharges at the points of interest for free flow are lower than the peak discharges with detention. Detention basins would also be difficult to construct due to several site limitations, which are outlined in the drainage study.

SUBMITTED BY:

NAME: Brian Ladd () OWNER (x) OWNER'S AGENT
ADDRESS: 7301 West 133rd St, Suite 200 Tel.# (913) 381-1170
CITY, STATE, ZIP: Overland Park, KS 66213
Email: bladd@olsson.com SIGNATURE: *Brian Ladd*

FORWARDING MANAGER: _____ RECOMMENDATION () APPROVAL () DENIAL

SIGNATURE: _____ DATE: _____

GEORGE BINGER III, P.E. – CITY ENGINEER: () APPROVED () DENIED

SIGNATURE: _____ DATE: _____

COMMENTS _____

A COPY MUST BE ATTACHED TO THE APPROVED PLANS

Development Services

220 SE Green Street | Lee's Summit, MO 64063 | P: 816.969.1200 | F: 816.969.1221 | cityofLS.net

APPENDIX H

Extended Detention Calculations

Note: 1001.88 CF of storage required per acre per PondPack (TR-55)

Water Quality Basin 1 - Drainage Area = 9.95 acres, Required Storage = 9,971 cf

Elevation (ft)	Area (sf)	A1+A2+SQR[A1*A2] (sf)	Volume (cf)	Volume Sum (cf)	Volume Sum (ac-ft)	Area (ac)
934.0	16,948	0	0	0	0.00	0.39
935.0	1,8511	53,171	17,724	17,724	0.41	0.43

Water Quality Basin 2 - Drainage Area = 9.20 acres, Required Storage = 9,219 cf

Elevation (ft)	Area (sf)	A1+A2+SQR[A1*A2] (sf)	Volume (cf)	Volume Sum (cf)	Volume Sum (ac-ft)	Area (ac)
944.0	10,013	0	0	0	0.00	0.23
945.0	11,536	32,297	10,766	10,766	0.25	0.27

Water Quality Basin 3 - Drainage Area = 12.76 acres, Required Storage = 12,786 cf

Elevation (ft)	Area (sf)	A1+A2+SQR[A1*A2] (sf)	Volume (cf)	Volume Sum (cf)	Volume Sum (ac-ft)	Area (ac)
944.0	15,882	0	0	0	0.00	0.37
945.0	17,323	49,792	16,597	16,597	0.38	0.40

Water Quality Basin 4 - Drainage Area = 24.46 acres, Required Storage = 24,503 cf

Elevation (ft)	Area (sf)	A1+A2+SQR[A1*A2] (sf)	Volume (cf)	Volume Sum (cf)	Volume Sum (ac-ft)	Area (ac)
941.5	18,531	0	0	0	0.00	0.43
942.0	20,841	59,024	9,837	9,837	0.23	0.48
943.0	23,212	66,048	22,016	31,853	0.73	0.53

Water Quality Basin 5 - Drainage Area = 8.06 acres, Required Storage = 8,077 cf

Elevation (ft)	Area (sf)	A1+A2+SQR[A1*A2] (sf)	Volume (cf)	Volume Sum (cf)	Volume Sum (ac-ft)	Area (ac)
955.5	5,798	0	0	0	0.00	0.133
956.0	6,681	18,703	3,117	3,117	0.07	0.153
957.0	7,635	21,458	7,153	10,270	0.24	0.175

Table of Contents

	Master Network Summary	1
KCMO TR-55	Time-Depth Curve, 1 years	2
CM-1	Runoff CN-Area, 1 years	4
	Unit Hydrograph Equations	5
CM-1		
	Unit Hydrograph Summary, 1 years	7
	Unit Hydrograph (Hydrograph Table), 1 years	9
O-2	Addition Summary, 1 years	11

Subsection: Master Network Summary

Catchments Summary

Label	Scenario	Return Event (years)	Hydrograph Volume (ac-ft)	Time to Peak (hours)	Peak Flow (ft ³ /s)
CM-1	Base	1	0.023	12.000	0.34

Node Summary

Label	Scenario	Return Event (years)	Hydrograph Volume (ac-ft)	Time to Peak (hours)	Peak Flow (ft ³ /s)
O-2	Base	1	0.023	12.000	0.34

Subsection: Time-Depth Curve
 Label: KCMO TR-55

Return Event: 1 years
 Storm Event: WQ STORM

Time-Depth Curve: WQ STORM

Label	WQ STORM
Start Time	0.000 hours
Increment	0.100 hours
End Time	24.000 hours
Return Event	1 years

CUMULATIVE RAINFALL (in)
Output Time Increment = 0.100 hours
Time on left represents time for first value in each row.

Time (hours)	Depth (in)	Depth (in)	Depth (in)	Depth (in)	Depth (in)
0.000	0.0	0.0	0.0	0.0	0.0
0.500	0.0	0.0	0.0	0.0	0.0
1.000	0.0	0.0	0.0	0.0	0.0
1.500	0.0	0.0	0.0	0.0	0.0
2.000	0.0	0.0	0.0	0.0	0.0
2.500	0.0	0.0	0.0	0.0	0.0
3.000	0.0	0.0	0.1	0.1	0.1
3.500	0.1	0.1	0.1	0.1	0.1
4.000	0.1	0.1	0.1	0.1	0.1
4.500	0.1	0.1	0.1	0.1	0.1
5.000	0.1	0.1	0.1	0.1	0.1
5.500	0.1	0.1	0.1	0.1	0.1
6.000	0.1	0.1	0.1	0.1	0.1
6.500	0.1	0.1	0.1	0.1	0.1
7.000	0.1	0.1	0.1	0.1	0.1
7.500	0.1	0.2	0.2	0.2	0.2
8.000	0.2	0.2	0.2	0.2	0.2
8.500	0.2	0.2	0.2	0.2	0.2
9.000	0.2	0.2	0.2	0.2	0.2
9.500	0.2	0.2	0.2	0.2	0.2
10.000	0.2	0.3	0.3	0.3	0.3
10.500	0.3	0.3	0.3	0.3	0.3
11.000	0.3	0.3	0.3	0.4	0.4
11.500	0.4	0.4	0.5	0.6	0.8
12.000	0.9	0.9	1.0	1.0	1.0
12.500	1.0	1.0	1.0	1.0	1.0
13.000	1.1	1.1	1.1	1.1	1.1
13.500	1.1	1.1	1.1	1.1	1.1
14.000	1.1	1.1	1.1	1.1	1.1
14.500	1.1	1.2	1.2	1.2	1.2
15.000	1.2	1.2	1.2	1.2	1.2
15.500	1.2	1.2	1.2	1.2	1.2
16.000	1.2	1.2	1.2	1.2	1.2
16.500	1.2	1.2	1.2	1.2	1.2
17.000	1.2	1.2	1.2	1.2	1.2
17.500	1.2	1.3	1.3	1.3	1.3

Subsection: Time-Depth Curve
 Label: KCMO TR-55

Return Event: 1 years
 Storm Event: WQ STORM

CUMULATIVE RAINFALL (in)
Output Time Increment = 0.100 hours
Time on left represents time for first value in each row.

Time (hours)	Depth (in)	Depth (in)	Depth (in)	Depth (in)	Depth (in)
18.000	1.3	1.3	1.3	1.3	1.3
18.500	1.3	1.3	1.3	1.3	1.3
19.000	1.3	1.3	1.3	1.3	1.3
19.500	1.3	1.3	1.3	1.3	1.3
20.000	1.3	1.3	1.3	1.3	1.3
20.500	1.3	1.3	1.3	1.3	1.3
21.000	1.3	1.3	1.3	1.3	1.3
21.500	1.3	1.3	1.3	1.3	1.3
22.000	1.3	1.3	1.3	1.3	1.3
22.500	1.3	1.3	1.3	1.4	1.4
23.000	1.4	1.4	1.4	1.4	1.4
23.500	1.4	1.4	1.4	1.4	1.4
24.000	1.4	(N/A)	(N/A)	(N/A)	(N/A)

Subsection: Runoff CN-Area
Label: CM-1

Return Event: 1 years
Storm Event: WQ STORM

Runoff Curve Number Data

Soil/Surface Description	CN	Area (ft ²)	C (%)	UC (%)	Adjusted CN
pervious	74.000	28,314.000	0.0	0.0	74.000
impervious	98.000	15,246.000	0.0	0.0	98.000
COMPOSITE AREA & WEIGHTED CN --->	(N/A)	43,560.000	(N/A)	(N/A)	82.400

Subsection: Unit Hydrograph Equations

Unit Hydrograph Method (Computational Notes)

Definition of Terms

At	Total area (acres): $A_t = A_i + A_p$
Ai	Impervious area (acres)
Ap	Pervious area (acres)
CNi	Runoff curve number for impervious area
CNp	Runoff curve number for pervious area
fLoss	f loss constant infiltration (depth/time)
gKs	Saturated Hydraulic Conductivity (depth/time)
Md	Volumetric Moisture Deficit
Psi	Capillary Suction (length)
hK	Horton Infiltration Decay Rate (time^{-1})
fo	Initial Infiltration Rate (depth/time)
fc	Ultimate(capacity)Infiltration Rate (depth/time)
Ia	Initial Abstraction (length)
dt	Computational increment (duration of unit excess rainfall) Default dt is smallest value of $0.1333T_c$, r_{tm} , and t_h (Smallest dt is then adjusted to match up with T_p)
UDdt	User specified override computational main time increment (only used if UDdt is $\Rightarrow .1333T_c$)
D(t)	Point on distribution curve (fraction of P) for time step t
K	$2 / (1 + (T_r/T_p))$: default $K = 0.75$: (for $T_r/T_p = 1.67$)
Ks	Hydrograph shape factor = Unit Conversions * $K = ((1\text{hr}/3600\text{sec}) * (1\text{ft}/12\text{in}) * ((5280\text{ft})^2/\text{sq.mi})) * K$ Default $K_s = 645.333 * 0.75 = 484$
Lag	Lag time from center of excess runoff (dt) to T_p : $\text{Lag} = 0.6T_c$
P	Total precipitation depth, inches
Pa(t)	Accumulated rainfall at time step t
Pi(t)	Incremental rainfall at time step t
qp	Peak discharge (cfs) for 1in. runoff, for 1hr, for 1 sq.mi. = $(K_s * A * Q) / T_p$ (where $Q = 1\text{in. runoff}$, $A = \text{sq.mi.}$)
Qu(t)	Unit hydrograph ordinate (cfs) at time step t
Q(t)	Final hydrograph ordinate (cfs) at time step t
Rai(t)	Accumulated runoff (inches) at time step t for impervious area
Rap(t)	Accumulated runoff (inches) at time step t for pervious area
Rii(t)	Incremental runoff (inches) at time step t for impervious area
Rip(t)	Incremental runoff (inches) at time step t for pervious area
R(t)	Incremental weighted total runoff (inches)
Rtm	Time increment for rainfall table
Si	S for impervious area: $S_i = (1000/CN_i) - 10$
Sp	S for pervious area: $S_p = (1000/CN_p) - 10$
t	Time step (row) number
Tc	Time of concentration
Tb	Time (hrs) of entire unit hydrograph: $T_b = T_p + T_r$
Tp	Time (hrs) to peak of a unit hydrograph: $T_p = (dt/2) + \text{Lag}$
Tr	Time (hrs) of receding limb of unit hydrograph: $T_r = \text{ratio of } T_p$

Subsection: Unit Hydrograph Equations

Unit Hydrograph Method

Computational Notes

Precipitation

Column (1) Time for time step t
Column (2) $D(t)$ = Point on distribution curve for time step t
Column (3) $P_i(t) = P_a(t) - P_a(t-1)$: Col.(4) - Preceding Col.(4)
Column (4) $P_a(t) = D(t) \times P$: Col.(2) x P

Pervious Area Runoff (using SCS Runoff CN Method)

Column (5) $R_{ap}(t)$ = Accumulated pervious runoff for time step t
If $(P_a(t))$ is $\leq 0.2Sp$ then use: $R_{ap}(t) = 0.0$
If $(P_a(t))$ is $> 0.2Sp$ then use:
 $R_{ap}(t) = (Col.(4) - 0.2Sp) \times 2 / (Col.(4) + 0.8Sp)$
Column (6) $R_{ip}(t)$ = Incremental pervious runoff for time step t
 $R_{ip}(t) = R_{ap}(t) - R_{ap}(t-1)$
 $R_{ip}(t) = Col.(5)$ for current row - $Col.(5)$ for preceding row.

Impervious Area Runoff

Column (7 & 8)... Did not specify to use impervious areas.

Incremental Weighted Runoff

Column (9) $R(t) = (A_p/A_t) \times R_{ip}(t) + (A_i/A_t) \times R_{ii}(t)$
 $R(t) = (A_p/A_t) \times Col.(6) + (A_i/A_t) \times Col.(8)$

SCS Unit Hydrograph Method

Column (10) $Q(t)$ is computed with the SCS unit hydrograph method using $R(t)$ and $Q_u(t)$.

Subsection: Unit Hydrograph Summary
 Label: CM-1

Return Event: 1 years
 Storm Event: WQ STORM

Storm Event	WQ STORM
Return Event	1 years
Duration	24.000 hours
Depth	1.4 in
Time of Concentration (Composite)	0.150 hours
Area (User Defined)	43,560.000 ft ²
Computational Time Increment	0.020 hours
Time to Peak (Computed)	12.020 hours
Flow (Peak, Computed)	0.35 ft ³ /s
Output Increment	0.050 hours
Time to Flow (Peak Interpolated Output)	12.000 hours
Flow (Peak Interpolated Output)	0.34 ft ³ /s
Drainage Area	
SCS CN (Composite)	82.000
Area (User Defined)	43,560.000 ft ²
Maximum Retention (Pervious)	2.2 in
Maximum Retention (Pervious, 20 percent)	0.4 in
Cumulative Runoff	
Cumulative Runoff Depth (Pervious)	0.3 in
Runoff Volume (Pervious)	0.023 ac-ft
Hydrograph Volume (Area under Hydrograph curve)	
Volume	0.023 ac-ft
SCS Unit Hydrograph Parameters	
Time of Concentration (Composite)	0.150 hours
Computational Time Increment	0.020 hours
Unit Hydrograph Shape Factor	483.432
K Factor	0.749
Receding/Rising, Tr/Tp	1.670
Unit peak, qp	7.55 ft ³ /s
Unit peak time, Tp	0.100 hours

Subsection: Unit Hydrograph Summary
Label: CM-1

Return Event: 1 years
Storm Event: WQ STORM

SCS Unit Hydrograph Parameters	
Unit receding limb, Tr	0.400 hours
Total unit time, Tb	0.500 hours

Subsection: Unit Hydrograph (Hydrograph Table)
 Label: CM-1

Return Event: 1 years
 Storm Event: WQ STORM

Storm Event	WQ STORM
Return Event	1 years
Duration	24.000 hours
Depth	1.4 in
Time of Concentration (Composite)	0.150 hours
Area (User Defined)	43,560.000 ft ²

HYDROGRAPH ORDINATES (ft³/s)
Output Time Increment = 0.050 hours

Time on left represents time for first value in each row.

Time (hours)	Flow (ft ³ /s)	Flow (ft ³ /s)	Flow (ft ³ /s)	Flow (ft ³ /s)	Flow (ft ³ /s)
11.650	0.00	0.00	0.01	0.04	0.09
11.900	0.19	0.29	0.34	0.33	0.25
12.150	0.16	0.11	0.09	0.08	0.07
12.400	0.07	0.06	0.06	0.05	0.05
12.650	0.05	0.04	0.04	0.04	0.04
12.900	0.04	0.04	0.04	0.03	0.03
13.150	0.03	0.03	0.03	0.03	0.03
13.400	0.03	0.03	0.03	0.03	0.03
13.650	0.03	0.03	0.03	0.02	0.02
13.900	0.02	0.02	0.02	0.02	0.02
14.150	0.02	0.02	0.02	0.02	0.02
14.400	0.02	0.02	0.02	0.02	0.02
14.650	0.02	0.02	0.02	0.02	0.02
14.900	0.02	0.02	0.02	0.02	0.02
15.150	0.02	0.02	0.02	0.02	0.02
15.400	0.02	0.02	0.02	0.02	0.02
15.650	0.02	0.02	0.02	0.02	0.02
15.900	0.02	0.02	0.01	0.01	0.01
16.150	0.01	0.01	0.01	0.01	0.01
16.400	0.01	0.01	0.01	0.01	0.01
16.650	0.01	0.01	0.01	0.01	0.01
16.900	0.01	0.01	0.01	0.01	0.01
17.150	0.01	0.01	0.01	0.01	0.01
17.400	0.01	0.01	0.01	0.01	0.01
17.650	0.01	0.01	0.01	0.01	0.01
17.900	0.01	0.01	0.01	0.01	0.01
18.150	0.01	0.01	0.01	0.01	0.01
18.400	0.01	0.01	0.01	0.01	0.01
18.650	0.01	0.01	0.01	0.01	0.01
18.900	0.01	0.01	0.01	0.01	0.01
19.150	0.01	0.01	0.01	0.01	0.01
19.400	0.01	0.01	0.01	0.01	0.01
19.650	0.01	0.01	0.01	0.01	0.01
19.900	0.01	0.01	0.01	0.01	0.01
20.150	0.01	0.01	0.01	0.01	0.01

Subsection: Unit Hydrograph (Hydrograph Table)
 Label: CM-1

Return Event: 1 years
 Storm Event: WQ STORM

HYDROGRAPH ORDINATES (ft³/s)
Output Time Increment = 0.050 hours
Time on left represents time for first value in each row.

Time (hours)	Flow (ft ³ /s)	Flow (ft ³ /s)	Flow (ft ³ /s)	Flow (ft ³ /s)	Flow (ft ³ /s)
20.400	0.01	0.01	0.01	0.01	0.01
20.650	0.01	0.01	0.01	0.01	0.01
20.900	0.01	0.01	0.01	0.01	0.01
21.150	0.01	0.01	0.01	0.01	0.01
21.400	0.01	0.01	0.01	0.01	0.01
21.650	0.01	0.01	0.01	0.01	0.01
21.900	0.01	0.01	0.01	0.01	0.01
22.150	0.01	0.01	0.01	0.01	0.01
22.400	0.01	0.01	0.01	0.01	0.01
22.650	0.01	0.01	0.01	0.01	0.01
22.900	0.01	0.01	0.01	0.01	0.01
23.150	0.01	0.01	0.01	0.01	0.01
23.400	0.01	0.01	0.01	0.01	0.01
23.650	0.01	0.01	0.01	0.01	0.01
23.900	0.01	0.01	0.01	(N/A)	(N/A)

Subsection: Addition Summary
Label: O-2

Return Event: 1 years
Storm Event: WQ STORM

Summary for Hydrograph Addition at 'O-2'

Upstream Link	Upstream Node
<Catchment to Outflow Node>	CM-1

Node Inflows

Inflow Type	Element	Volume (ac-ft)	Time to Peak (hours)	Flow (Peak) (ft ³ /s)
Flow (From)	CM-1	0.023	12.000	0.34
Flow (In)	O-2	0.023	12.000	0.34

Index

C

CM-1 (Runoff CN-Area, 1 years)...4

CM-1 (Unit Hydrograph (Hydrograph Table), 1 years)...9, 10

CM-1 (Unit Hydrograph Summary, 1 years)...7, 8

K

KCMO TR-55 (Time-Depth Curve, 1 years)...2, 3

M

Master Network Summary...1

O

O-2 (Addition Summary, 1 years)...11

U

Unit Hydrograph Equations...5, 6

HOOK FARMS SECOND PLAT

Lee's Summit, MO

January 2021

Olsson Project No. B19-4061