

FCC600 Six-Inch Round Cylinder – Wall, Pendant, or Surface Mount Down Lighting

Remote Driver with Battery Backup



FEATURES

- Up to 5000 lumens (4000K)
- Multiple mounting options
- Clear anti-glare tempered glass lens (IK09)
- The Soft Field Lens option provides diffusion, reduces glare, and enhances visual comfort
- Multiple housing colors
- 0-10V 1% Dimming (Standard)
- 93 CRI with 2 SDCM

PERFORMANCE

Beam Spread: 15°, 25°, 40°, 50°, 72°, Wall Wash
CCT Options: 2700K, 3000K, 3500K, 4000K
CRI: 93 CRI
Consistency: 2 SDCM (Luminaire to Luminaire)
Lumens: 5000 lumens
Lumen Maintenance: L70 > 70,000 hours

PHYSICAL

Mounting: Mounts directly to standard recessed junction box with wall mount or twist-lock canopy. Additional holes allow unit to be attached directly to mounting surface. Not intended for open ceilings or surface mount conduit j-box applications. Recessed j-box must be flush with finished wall or ceiling surface.

Housing: Heavy-walled, extruded aluminum housing with high pressure die-cast lens ring and cap with stainless steel hardware.

Finish: Available in Black, Bronze, Graphite Grey, Silver, White and Custom Colors. Six stage chemical iron phosphate conversion pre-treatment. Polyester powder coat finish, 18 µm minimum, 5,000 hour salt spray test (ASTM B117) compliant with Florida / AAMA 2604 specification.

Warranty: 5-Year limited warranty

Lens: IK09 impact compliant, clear anti-glare tempered glass

Ingress Protection: Continuous silicone gasket to seal out contaminants, IP66 rated for dry, damp or wet locations. SF and SPM options are rated IP65 for cover ceiling application only.

Weight: 8-12 lbs (Depending on Length)

Operating Temperature: -22°F to 122°F (-30°C to 50°C)

ELECTRICAL

Voltage: Universal 120 - 277 VAC standard, 347 VAC optional

Power Supply: Integral Class II, electronic high-power factor >.90, THD < 20%, FCC Title 47 Part 15 Class A.

Power Consumption: Maximum 60W

Dimming: standard: 0-10V, 1% Dimming, **optional:** ELV, TRIAC, dim to off, DMX, DALI

Standards:

- cETLus Listed, CE, NOM, and RoHS Compliant.
- Wet location listed for wall or ceiling mount IP66 Ingress protection.
- 1.5G (ANSI C136.31) Vibration resistance rated.
- IK09 (IEC6226) Impact resistance rated.
- IESNA LM79 Photometric testing by NVLAP accredited test lab.
- IESNA LM80 LED testing by NVLAP accredited test lab.
- IESNA TM21 Luminaire lumen depreciation projection to > 70,000 hours.

PHYSICAL DIMENSIONS

Luminaire	Height (H)
FCC600R-08	8.95" Height
FCC600R-10	10.95" Height
FCC600R-12	12.95" Height
FCC600R-14	14.95" Height
FCC600R-16	16.95" Height
FCC600R-18	18.95" Height
FCC600R-20	20.95" Height

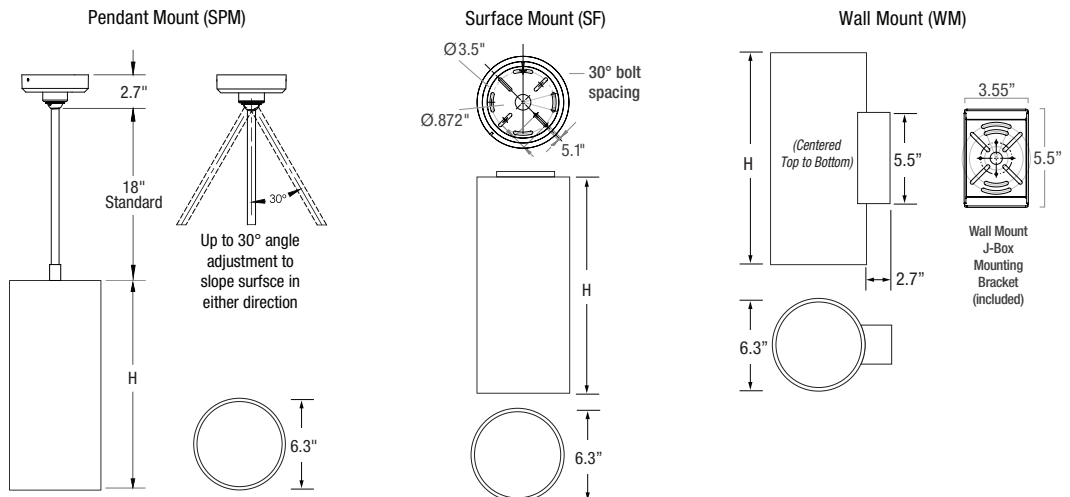

Date: _____
 Type: _____
 Luminaire: _____
 Project: _____

Approved: _____

FCC600 Six-Inch Round Cylinder – Wall, Pendant, or Surface Mount Down Lighting

PRODUCT CODE

EXAMPLE: FCC600R-10-SPM-18-UNV-927-05L-BKE-15-ET-CV

MODEL	HEIGHT	MOUNTING	SUSP. LENGTH	VOLTAGE	COLOR	LUMENS	FINISH	OPTIC	DIMMING	OPTIONS	BATTERY/REMOTE DRIVER
FCC600R											

<p>MODEL FCC600R LED DRIVER REMOTE (INDOOR) IP20, IK08, NEMA 1, -20°C to +50°C, 30' MAX Distance with 12AWG. *Consult factory for outdoor remote driver only.</p>	<p>HEIGHT</p> <table border="0"> <tr><td>08</td><td>8.95" Height</td></tr> <tr><td>10</td><td>10.95" Height</td></tr> <tr><td>12</td><td>12.95" Height</td></tr> <tr><td>14</td><td>14.95" Height</td></tr> <tr><td>16</td><td>16.95" Height</td></tr> <tr><td>18</td><td>18.95" Height</td></tr> <tr><td>20</td><td>20.95" Height</td></tr> </table>	08	8.95" Height	10	10.95" Height	12	12.95" Height	14	14.95" Height	16	16.95" Height	18	18.95" Height	20	20.95" Height	<p>MOUNTING</p> <table border="0"> <tr><td>SPM</td><td>Slope Pendant</td></tr> <tr><td>SF</td><td>Surface</td></tr> <tr><td>WM</td><td>Wall</td></tr> </table>	SPM	Slope Pendant	SF	Surface	WM	Wall	<p>COLOR</p> <table border="0"> <tr><td>927</td><td>(93CRI) 2700K</td></tr> <tr><td>930</td><td>(93CRI) 3000K</td></tr> <tr><td>935</td><td>(93CRI) 3500K</td></tr> <tr><td>940</td><td>(93CRI) 4000K</td></tr> </table>	927	(93CRI) 2700K	930	(93CRI) 3000K	935	(93CRI) 3500K	940	(93CRI) 4000K	<p>LUMENS typical</p> <table border="0"> <tr><td>05L</td><td>500 lm</td></tr> <tr><td>10L</td><td>1000 lm</td></tr> <tr><td>15L</td><td>1500 lm</td></tr> <tr><td>20L</td><td>2297 lm</td></tr> <tr><td>25L</td><td>2500 lm</td></tr> <tr><td>30L</td><td>3000 lm</td></tr> <tr><td>35L</td><td>3500 lm (Minimum 10"H)</td></tr> <tr><td>40L</td><td>4000 lm (Minimum 10"H)</td></tr> <tr><td>45L</td><td>4500 lm (Minimum 10"H)</td></tr> <tr><td>50L</td><td>5000 lm (Minimum 10"H)</td></tr> </table>	05L	500 lm	10L	1000 lm	15L	1500 lm	20L	2297 lm	25L	2500 lm	30L	3000 lm	35L	3500 lm (Minimum 10"H)	40L	4000 lm (Minimum 10"H)	45L	4500 lm (Minimum 10"H)	50L	5000 lm (Minimum 10"H)	<p>FINISH</p> <table border="0"> <tr><td>BKE</td><td>Black</td></tr> <tr><td>BRE</td><td>Bronze</td></tr> <tr><td>GRE</td><td>Graphite Grey</td></tr> <tr><td>SLE</td><td>Silver</td></tr> <tr><td>WHE</td><td>White</td></tr> <tr><td>CCE</td><td>Custom Color</td></tr> </table>	BKE	Black	BRE	Bronze	GRE	Graphite Grey	SLE	Silver	WHE	White	CCE	Custom Color	<p>OPTIC typical</p> <table border="0"> <tr><td>15</td><td>Spot (15°)</td></tr> <tr><td>25</td><td>Narrow Flood (25°)</td></tr> <tr><td>40</td><td>Mid Flood (40°)</td></tr> <tr><td>50</td><td>Flood (50°)</td></tr> <tr><td>72</td><td>Wide Flood (72°)</td></tr> </table> <p>w/SOFT FIELD</p> <table border="0"> <tr><td>15S</td><td>Spot (15°)</td></tr> <tr><td>25S</td><td>Narrow Flood (25°)</td></tr> <tr><td>40S</td><td>Mid Flood (40°)</td></tr> <tr><td>50S</td><td>Flood (50°)</td></tr> <tr><td>72S</td><td>Wide Flood (72°)</td></tr> <tr><td>WW</td><td>Wall Wash (50° Optic Only)</td></tr> </table>	15	Spot (15°)	25	Narrow Flood (25°)	40	Mid Flood (40°)	50	Flood (50°)	72	Wide Flood (72°)	15S	Spot (15°)	25S	Narrow Flood (25°)	40S	Mid Flood (40°)	50S	Flood (50°)	72S	Wide Flood (72°)	WW	Wall Wash (50° Optic Only)	<p>DIMMING</p> <table border="0"> <tr><td>ET</td><td>ELV or TRIAC Driver (20L-45L Only) (120V Phase Dimming w/ UNV Driver)</td></tr> <tr><td>LD</td><td>0-10V Dimming, 1% (Standard)</td></tr> </table> <p>*All drivers listed above are remote.</p>	ET	ELV or TRIAC Driver (20L-45L Only) (120V Phase Dimming w/ UNV Driver)	LD	0-10V Dimming, 1% (Standard)	<p>OPTIONS</p> <table border="0"> <tr><td>CV</td><td>Cut-Off Visor (Down Only)</td></tr> </table>	CV	Cut-Off Visor (Down Only)	<p>BATTERY/REMOTE DRIVER</p> <table border="0"> <tr><td>BBUR</td><td>BATTERY BACK-UP & LED DRIVER REMOTE (INDOOR), IP20, IK08, NEMA 1, 0°C to +48°C, 30' MAX Distance with 12AWG (w/UNV Option Only)</td></tr> <tr><td>BBUX</td><td>BATTERY BACK-UP & LED DRIVER REMOTE (OUTDOOR), IP67, IK10, NEMA 4X, -20°C to +55°C, 30' MAX Distance with 12AWG (w/UNV Option Only)</td></tr> <tr><td>DRR</td><td>LED Driver Only Remote (INDOOR) 30' MAX Distance with 12AWG (w/UNV Option Only)</td></tr> <tr><td>DRX</td><td>LED Driver Only Remote (OUTDOOR) 30' MAX Distance with 12AWG (w/UNV Option Only)</td></tr> </table>	BBUR	BATTERY BACK-UP & LED DRIVER REMOTE (INDOOR), IP20, IK08, NEMA 1, 0°C to +48°C, 30' MAX Distance with 12AWG (w/UNV Option Only)	BBUX	BATTERY BACK-UP & LED DRIVER REMOTE (OUTDOOR), IP67, IK10, NEMA 4X, -20°C to +55°C, 30' MAX Distance with 12AWG (w/UNV Option Only)	DRR	LED Driver Only Remote (INDOOR) 30' MAX Distance with 12AWG (w/UNV Option Only)	DRX	LED Driver Only Remote (OUTDOOR) 30' MAX Distance with 12AWG (w/UNV Option Only)
08	8.95" Height																																																																																																								
10	10.95" Height																																																																																																								
12	12.95" Height																																																																																																								
14	14.95" Height																																																																																																								
16	16.95" Height																																																																																																								
18	18.95" Height																																																																																																								
20	20.95" Height																																																																																																								
SPM	Slope Pendant																																																																																																								
SF	Surface																																																																																																								
WM	Wall																																																																																																								
927	(93CRI) 2700K																																																																																																								
930	(93CRI) 3000K																																																																																																								
935	(93CRI) 3500K																																																																																																								
940	(93CRI) 4000K																																																																																																								
05L	500 lm																																																																																																								
10L	1000 lm																																																																																																								
15L	1500 lm																																																																																																								
20L	2297 lm																																																																																																								
25L	2500 lm																																																																																																								
30L	3000 lm																																																																																																								
35L	3500 lm (Minimum 10"H)																																																																																																								
40L	4000 lm (Minimum 10"H)																																																																																																								
45L	4500 lm (Minimum 10"H)																																																																																																								
50L	5000 lm (Minimum 10"H)																																																																																																								
BKE	Black																																																																																																								
BRE	Bronze																																																																																																								
GRE	Graphite Grey																																																																																																								
SLE	Silver																																																																																																								
WHE	White																																																																																																								
CCE	Custom Color																																																																																																								
15	Spot (15°)																																																																																																								
25	Narrow Flood (25°)																																																																																																								
40	Mid Flood (40°)																																																																																																								
50	Flood (50°)																																																																																																								
72	Wide Flood (72°)																																																																																																								
15S	Spot (15°)																																																																																																								
25S	Narrow Flood (25°)																																																																																																								
40S	Mid Flood (40°)																																																																																																								
50S	Flood (50°)																																																																																																								
72S	Wide Flood (72°)																																																																																																								
WW	Wall Wash (50° Optic Only)																																																																																																								
ET	ELV or TRIAC Driver (20L-45L Only) (120V Phase Dimming w/ UNV Driver)																																																																																																								
LD	0-10V Dimming, 1% (Standard)																																																																																																								
CV	Cut-Off Visor (Down Only)																																																																																																								
BBUR	BATTERY BACK-UP & LED DRIVER REMOTE (INDOOR), IP20, IK08, NEMA 1, 0°C to +48°C, 30' MAX Distance with 12AWG (w/UNV Option Only)																																																																																																								
BBUX	BATTERY BACK-UP & LED DRIVER REMOTE (OUTDOOR), IP67, IK10, NEMA 4X, -20°C to +55°C, 30' MAX Distance with 12AWG (w/UNV Option Only)																																																																																																								
DRR	LED Driver Only Remote (INDOOR) 30' MAX Distance with 12AWG (w/UNV Option Only)																																																																																																								
DRX	LED Driver Only Remote (OUTDOOR) 30' MAX Distance with 12AWG (w/UNV Option Only)																																																																																																								

SPM LENGTH

Specify the optional suspension length in inches. (Top of luminaire to ceiling) (SPM 18" Standard, 6"-120" Max; 61"-120" w/LD & ET Only and stem comes in 2 sections) *Consult factory & price guide for other lengths.

VOLTAGE

UNV Universal 120 - 277 VAC
347V 347 VAC

FCC600 Six-Inch Round Cylinder – Wall, Pendant, or Surface Mount Down Lighting

LUMENS / WATTAGE typical

Model	Watts	940
FCC600R	60 W (Max)	500 lm (Min) 5000 lm (Max)

IES Multiplier	
Color	Multiplier
927	0.93
930	0.97
935	0.99
940	1.00

*83CRI±1.15 Consult factory.

TRIAC & ELV Approved Dimmer List	
Manufacturer	Manufacturer Part Number
Lutron	Glyder GLV-600
	Diva DVLV-600P
	Diva DV-600P
	Diva DVELV-600P(303)
	Maestro MALV-600
	Nova T NT-1000
	Nova T NTELV-600
Leviton	SureSlide 6633
	Illumatech IPE04

0-10V Approved Dimmer List	
Manufacturer	Manufacturer Part Number
Lutron	Diva DVSTV-XX
	Diva DVSTV-453PH-WH1
Leviton	Illumatech 010-IP710-DLZ

PHOTOMETRICS

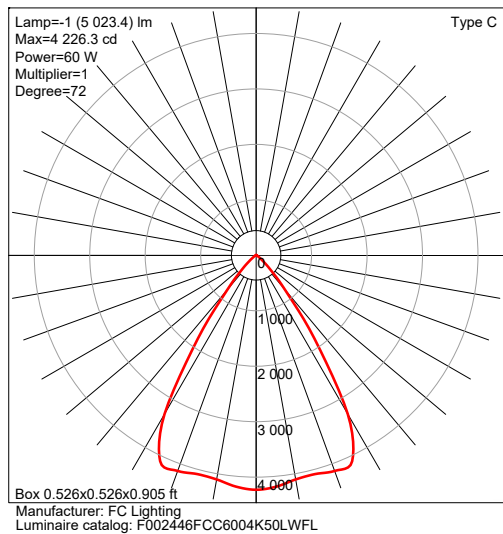
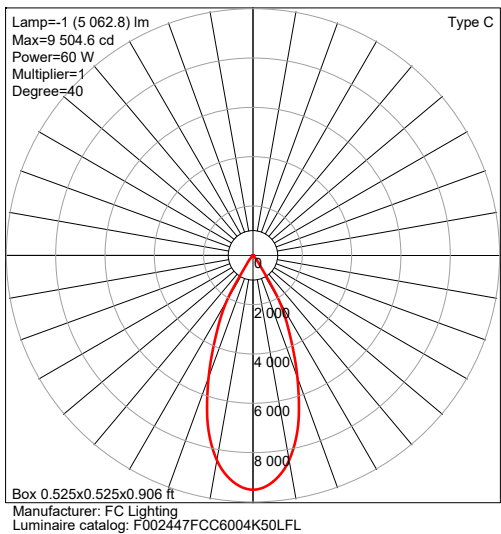
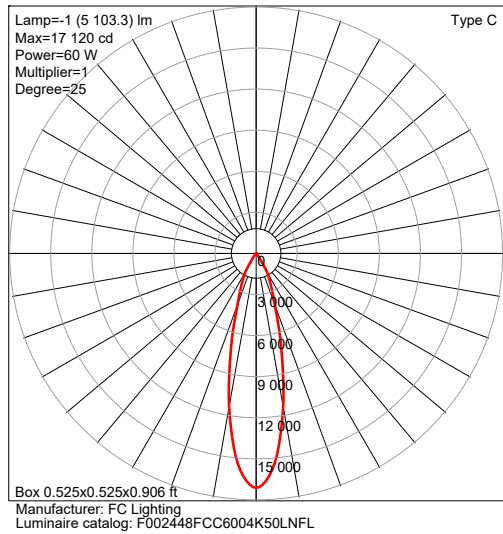
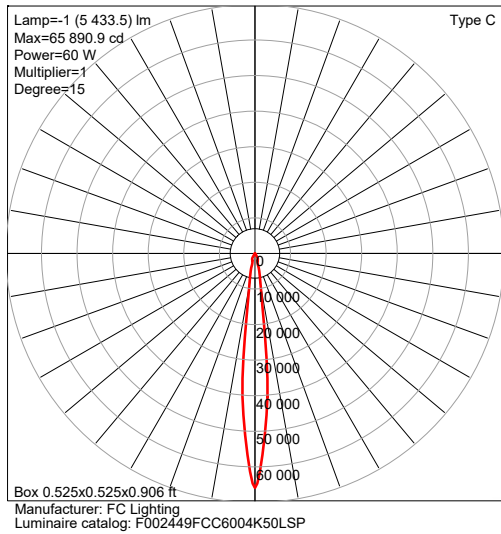

Due to continuous development and improvements, specifications are subject to change without notice.
Product use certifies agreement to FC Lighting, Inc. terms and conditions.

FCC600 Six-Inch Round Cylinder – Wall, Pendant, or Surface Mount Down Lighting

MORE DIMENSIONS

Cut-Off Visor (CV) *(Down Only)*

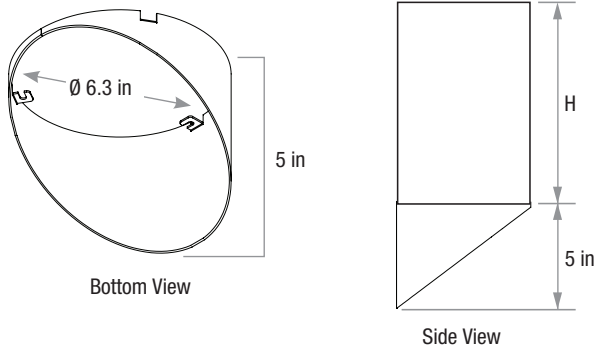

FCC600 Six-Inch Round Cylinder – Wall, Pendant, or Surface Mount Down Lighting

BATTERY BACK-UPS

BBUR - BATTERY BACK-UP & LED DRIVER REMOTE (INDOOR), IP20, IK08, NEMA 1, 0°C to +48°C, 30' MAX Distance with 12AWG (w/UNV Option Only)

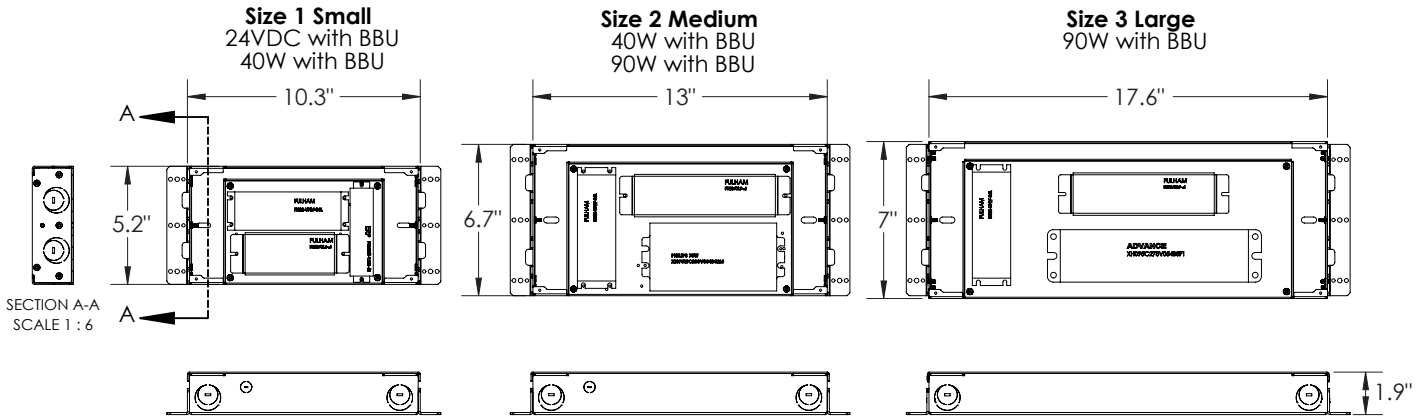

BBUX - BATTERY BACK-UP & LED DRIVER REMOTE (OUTDOOR), IP67, IK10, NEMA 4X, -20°C to +55°C, 30' MAX Distance with 12AWG (w/UNV Option Only)

